

BOARD OF DIRECTORS MEETING

May 16, 2023



PLEDGE OF ALLEGIANCE

I pledge allegiance to the flag of the United States of America, and to the republic for which it stands, one nation under God, indivisible, with liberty and justice for all.



PLEDGE OF ALLEGIANCE TO THE TEXAS FLAG

Honor the Texas flag; I pledge allegiance to thee, Texas, one state under God, one and indivisible.



2

Public Comment





3

Consider Approval of the Minutes from the Meeting Held on April 18, 2023



4

Consider Approval of Resolution to Canvass and Declare the Results of the May 6, 2023 Board of Directors Election

Stephen Tatum, *General Counsel*

Results of the May 6, 2023 Board of Directors Election

<u>Candidate</u>	<u>Total Votes</u>	<u>Percentage</u>
Paxton Motheral	18,691	32.22%
Chad Moore	10,551	18.19%
Joe Ashton	11,475	19.78%
Charles “C.B.” Team	17,299	29.82%



5

Administer Oaths of Office

Leah King, *Board President*



6

Consider Adoption of Resolution Honoring Martha V. Leonard

Leah King, *Board President*

7

Consider Approval of Contract with Quiddity Engineering LLC for Design Improvements to TRWD Outlet Dechlorination Facilities at Lakes Arlington and Benbrook

Jason Gehrig, *Infrastructure Engineering Director*

Quiddity Design Improvements for TRWD Outlet Dechlorination Facilities at Lakes Arlington and Benbrook

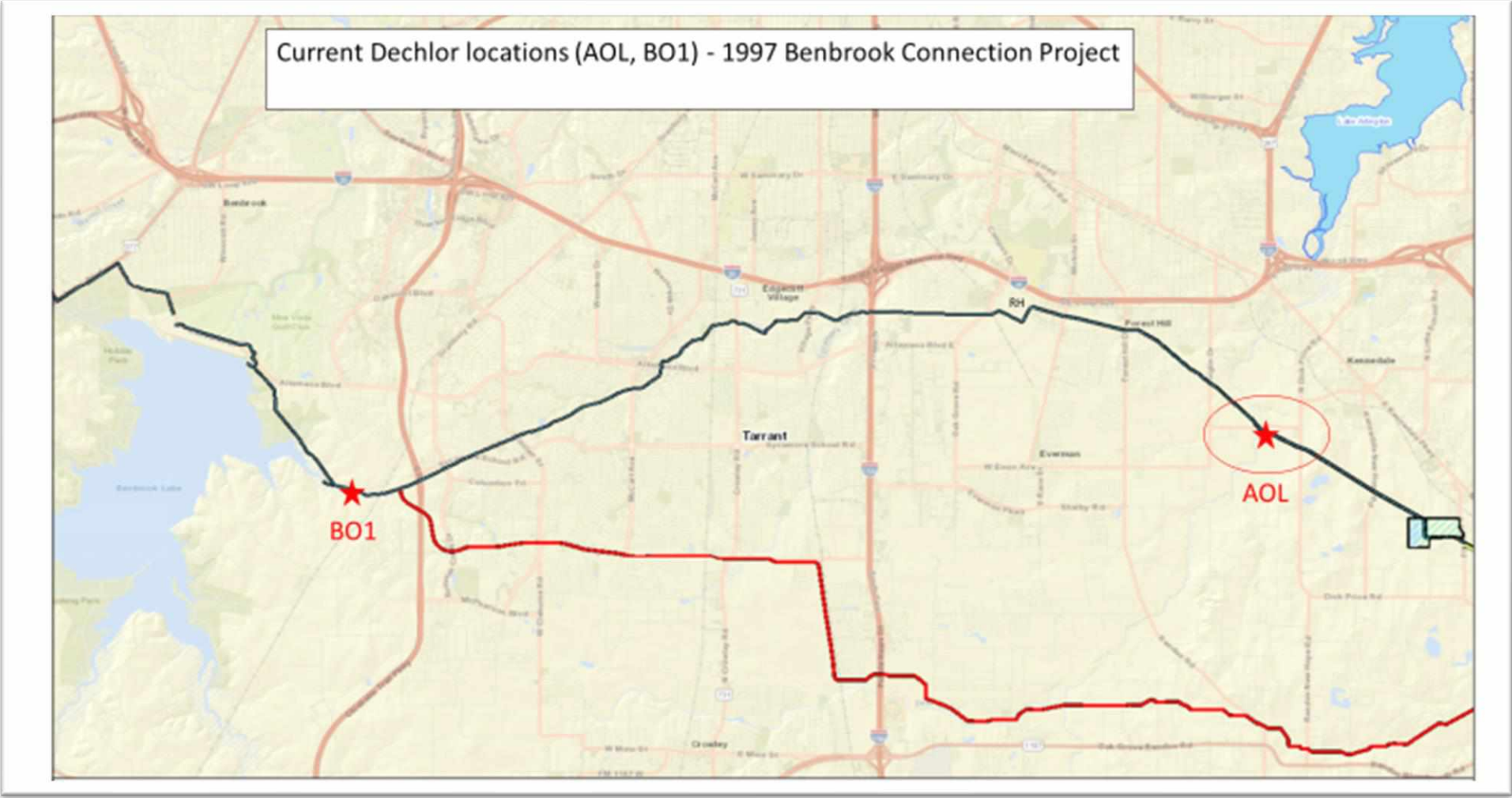

Quiddity Design Improvements for TRWD Outlet Dechlorination Facilities at Lakes Arlington and Benbrook

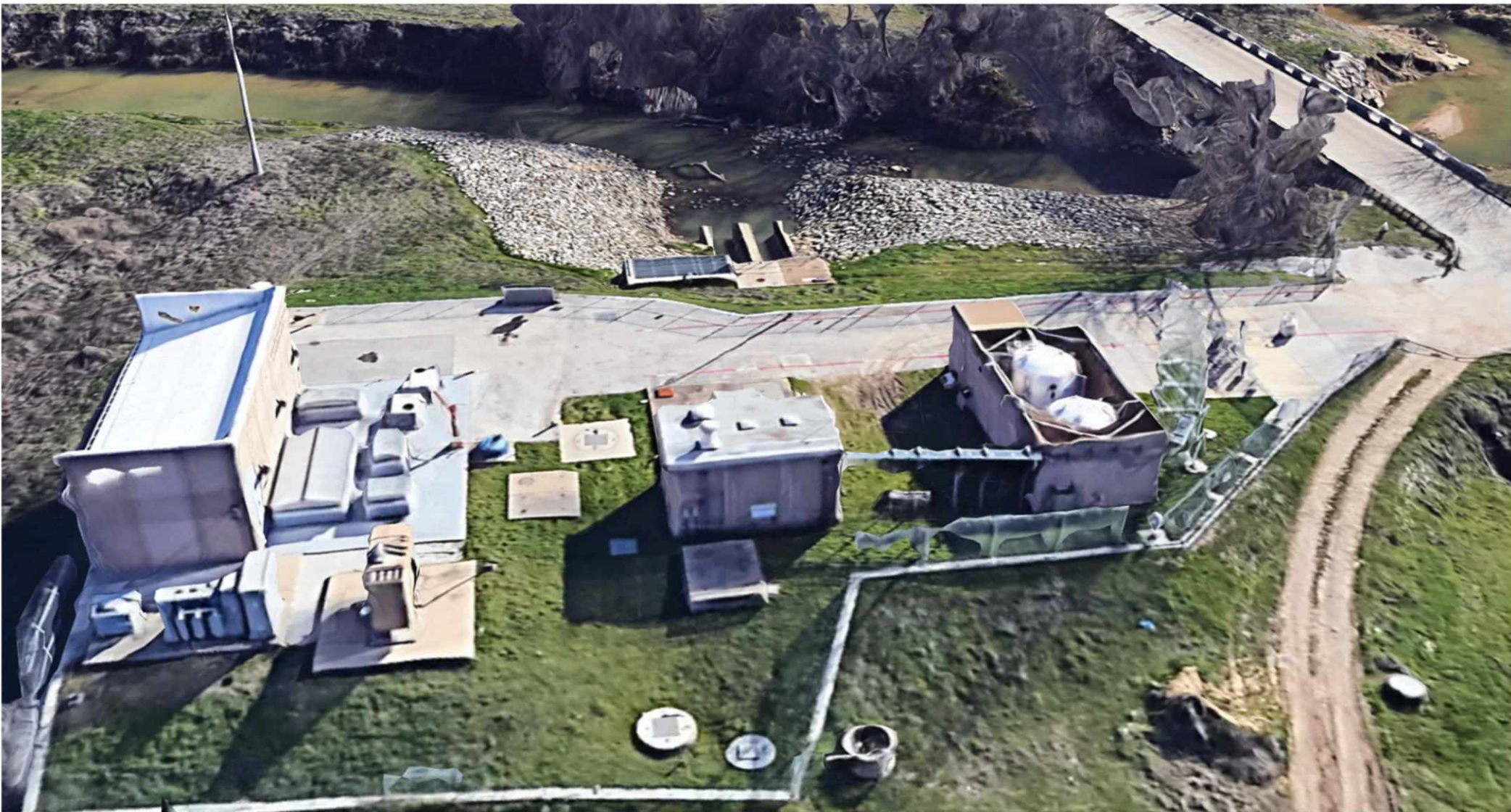

Quiddity Design Improvements for TRWD Outlet Dechlorination Facilities at Lakes Arlington and Benbrook

Arlington Outlet Existing Conditions

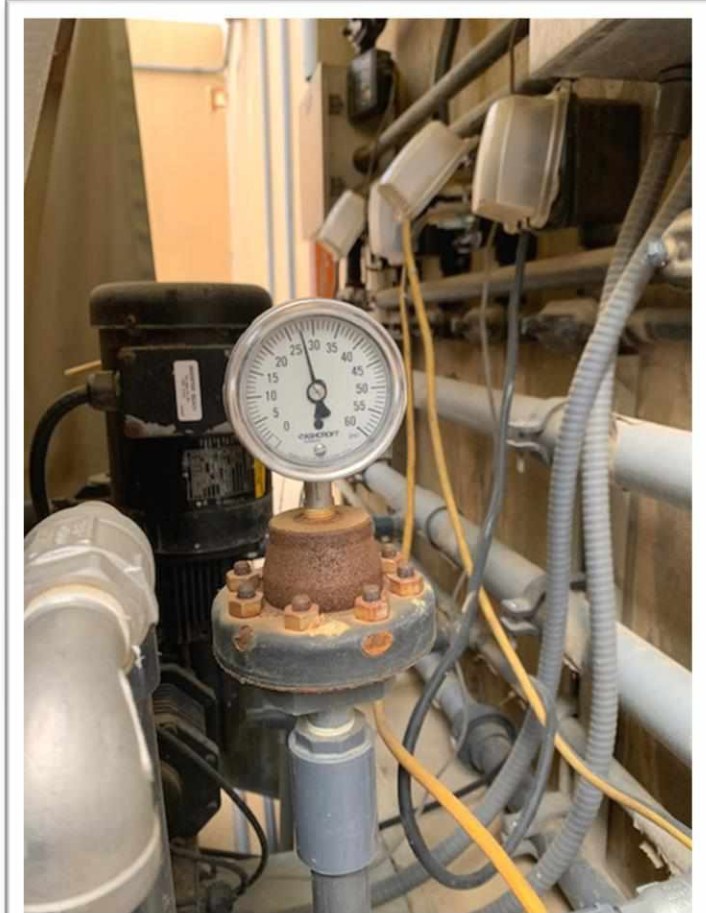
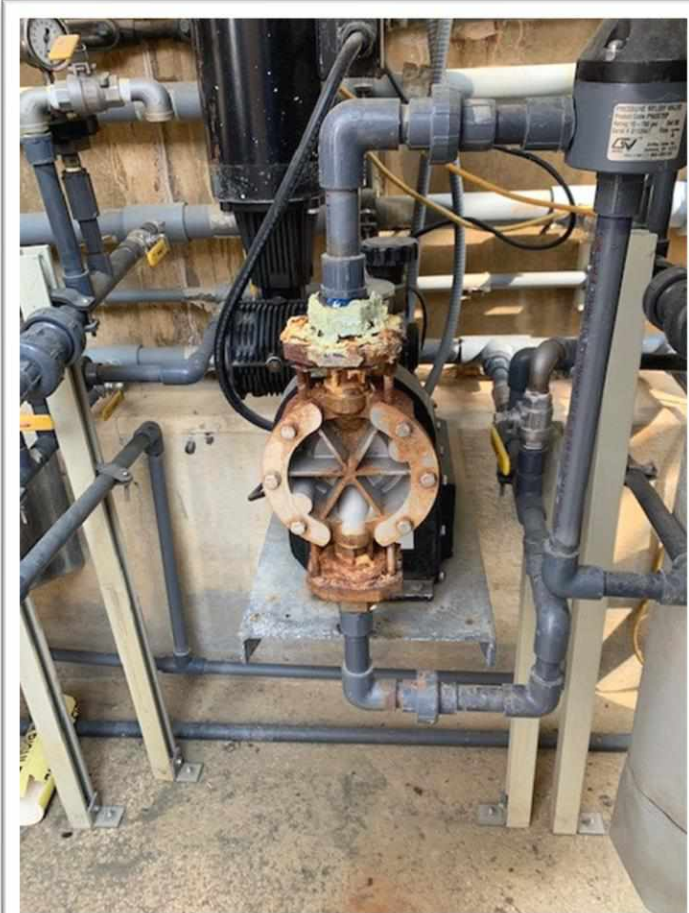

Quiddity Design Improvements for TRWD Outlet Dechlorination Facilities at Lakes Arlington and Benbrook

Benbrook
De-Chlorination
Existing
Conditions



8

Consider Approval of Change Orders with BAR Constructors, Inc. for the Kennedale Balancing Reservoir Yard Piping, Inlet and Outlet Modification Project

Jason Gehrig, Infrastructure Engineering Director

Kennedale Balancing Reservoir Yard Piping, Inlet and Outlet Modifications Construction Change Orders

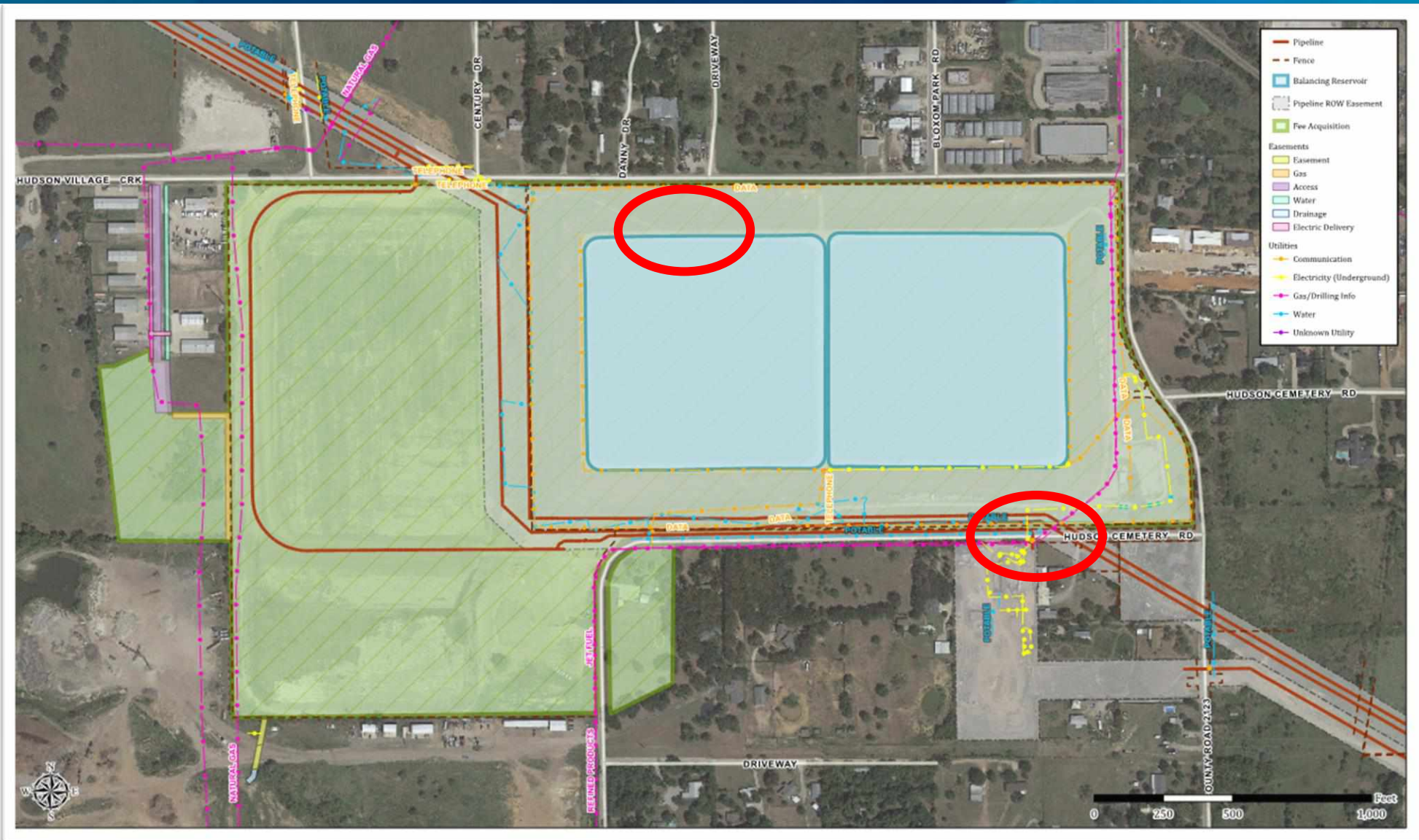

Kennedale Balancing Reservoir Yard Piping, Inlet and Outlet Modifications Construction Change Orders

\$40,423,763.92
change order for
protection against
corrosion for six
butterfly valves



Kennedale Balancing Reservoir Yard Piping, Inlet and Outlet Modifications Construction Change Orders

Not to exceed \$150,000 change order for removal of 48" inlet piping

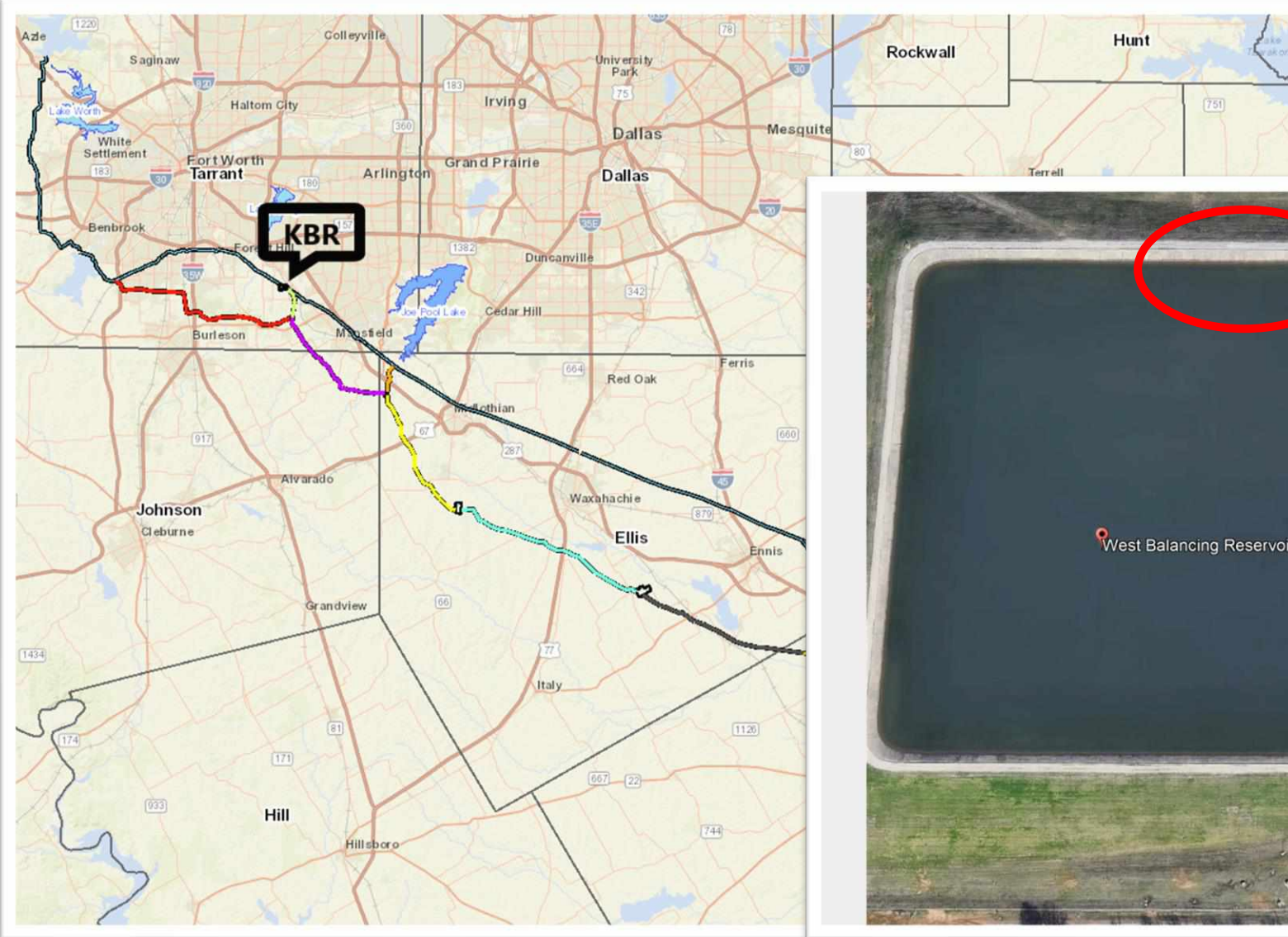

Kennedale Balancing Reservoir Yard Piping, Inlet and Outlet Modifications Construction Change Orders

Location of 48-inch inlet pipe in 60-inch grouted steel casing, according to 1999 record drawings

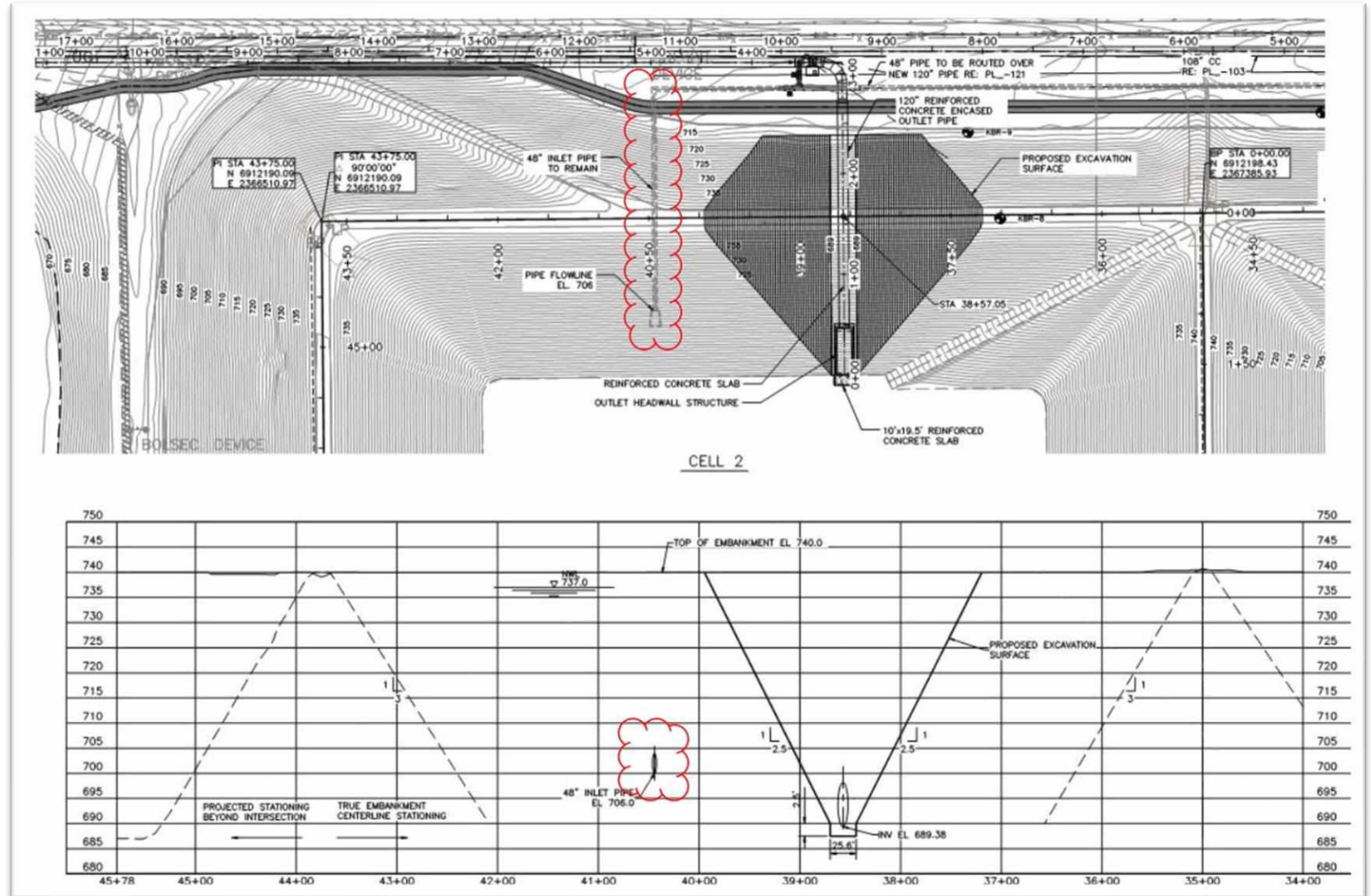

Kennedale Balancing Reservoir Yard Piping, Inlet and Outlet Modifications Construction Change Orders



Actual location of 48" inlet piping, within excavation zone for new 10-foot diameter outlet pipe

9

Consider Approval of Contract Amendment with Freese and Nichols, Inc. for Integrated Pipeline Project Phase 3 Program and Construction Management Services

Ed Weaver, IPL Program Manager

Integrated Pipeline – Phase 3 Program Management

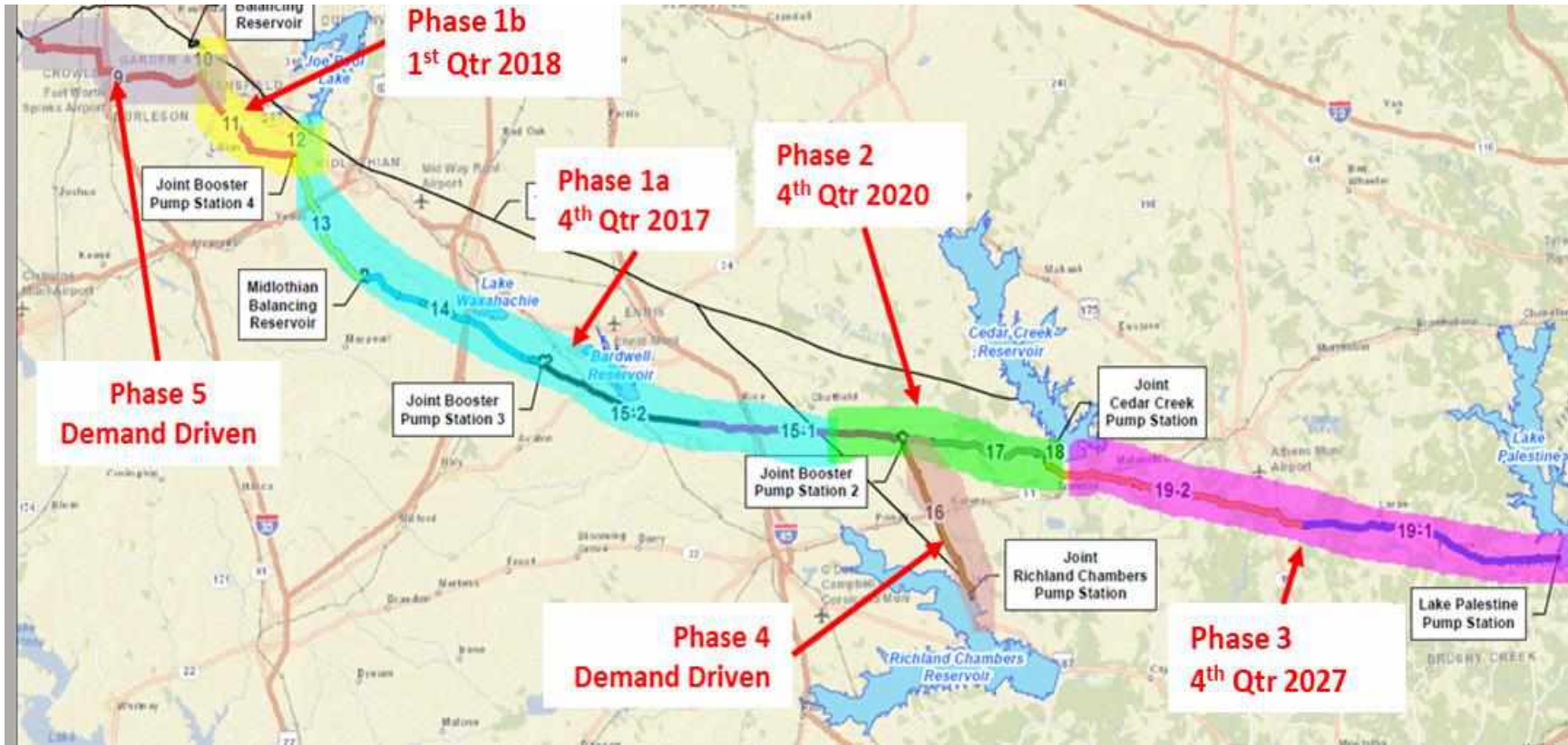

Phase 3 Design and Construction --

- PL sections 19-1 and 19-2
- PL19 TXDOT and Long Tunnels
- Lake Palestine intake and lake pump station (LP1)
- 138 kV substation
- Owner Furnished Equipment – pumps motors and drives, 108” and 84” gate and butterfly valves
- Microwave, SCADA and Security communication systems
- Phase 3 operational Fall 2027
- PI 19-1 and 19-2 Right-of-Way set
- LP1 site Dallas acquired
- 100% Dallas funded

Phase 3 IPL Section 19 TXDOT Tunnel Crossings

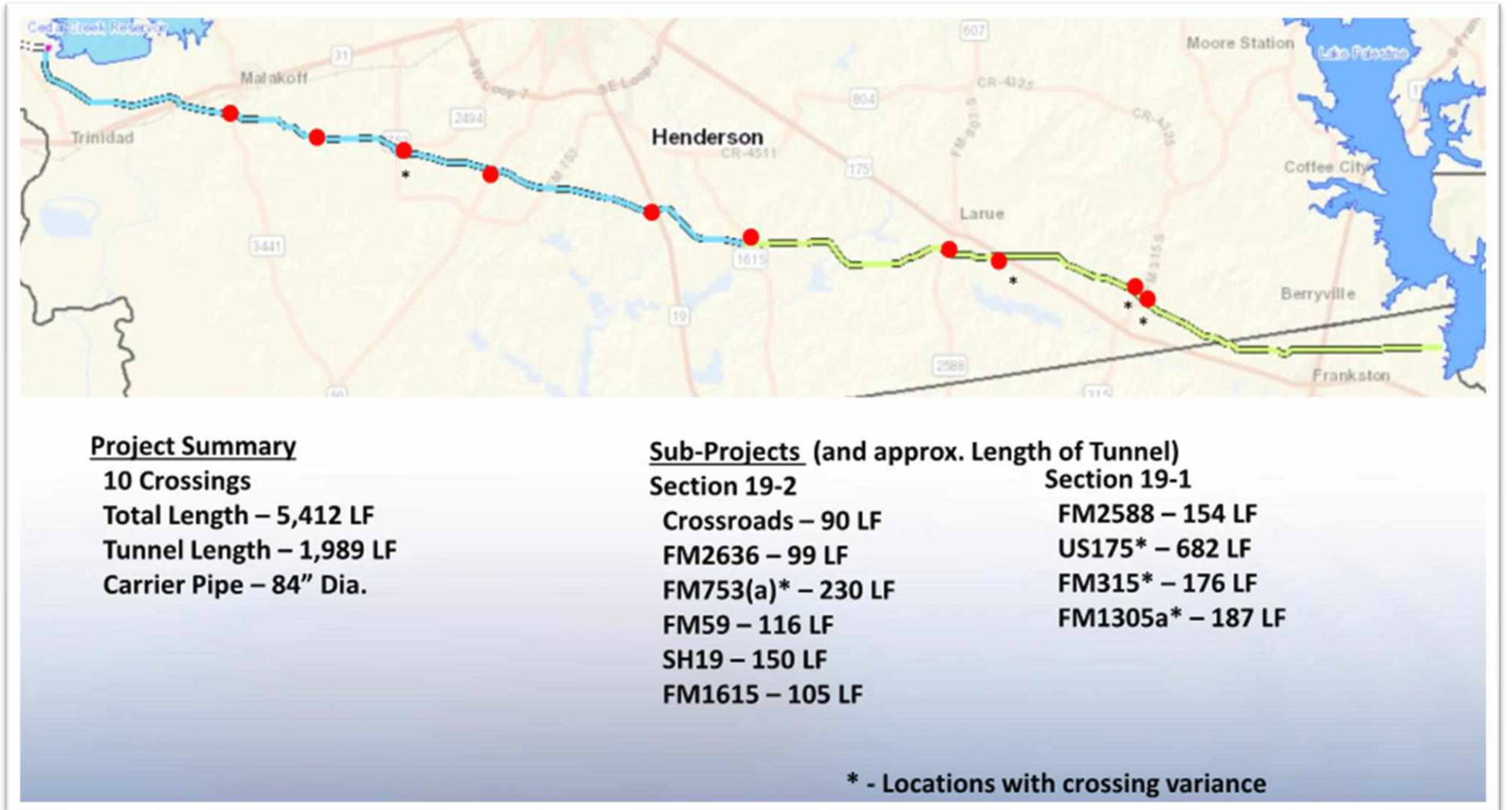

Integrated Pipeline Long Tunnels Project

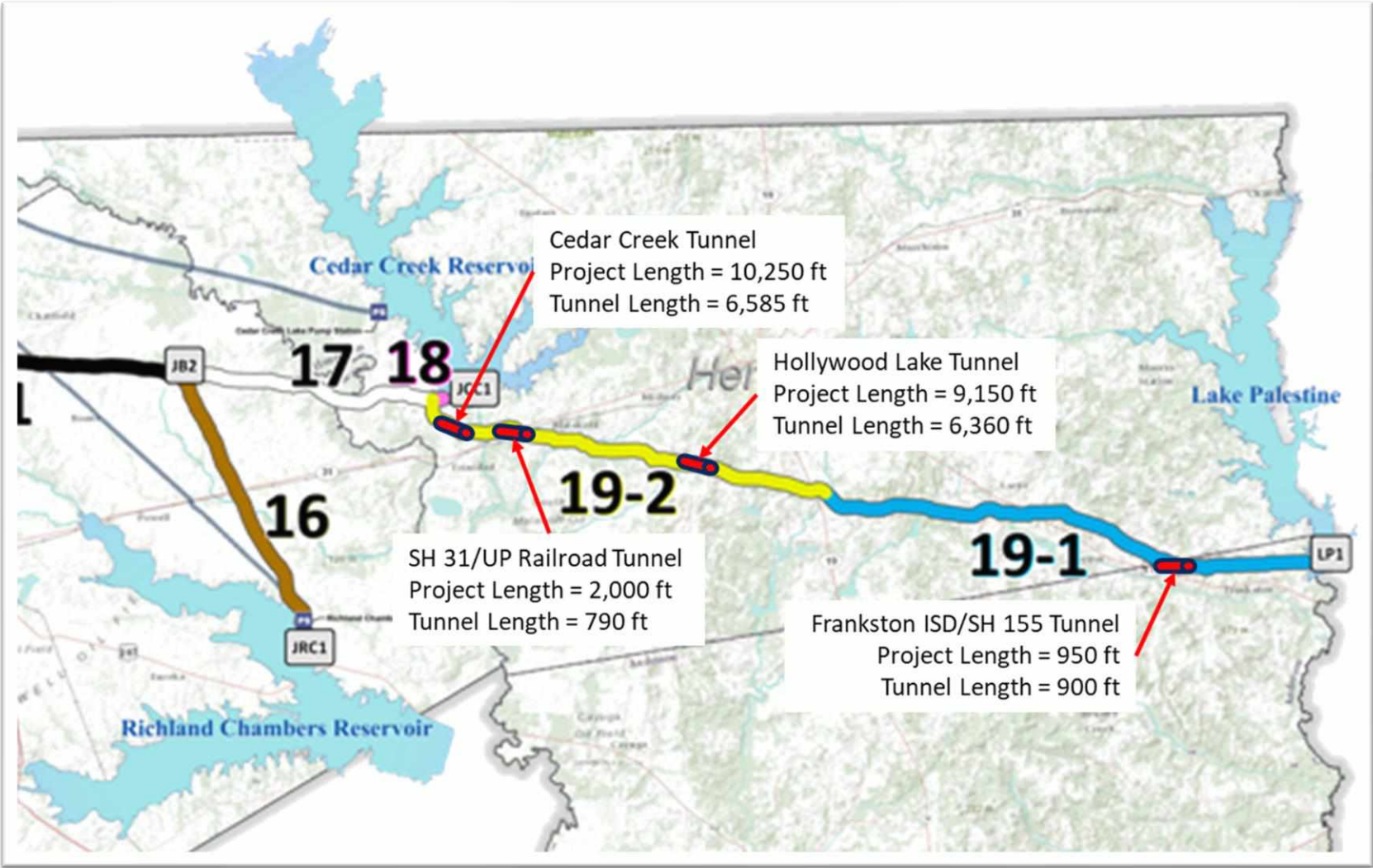

Phase 3 Integrated Pipeline Lake Palestine Pump Station Intake and Wet Well



Phase 3 Integrated Pipeline



Phase 3 Integrated Pipeline PL19 Long Tunnels Project -- Tunnel Boring Machine



10

Consider Approval of Contract Amendment with Plus Six Engineering, LLC for Integrated Pipeline Project Phase 3 Program and Construction Management Services

Ed Weaver, IPL Program Manager

11

Consider Approval of Change Order to Contract with Traylor Sundt Joint Venture for Section 19 Long Tunnel Crossings of the Integrated Pipeline Project

Ed Weaver, *IPL Program Manager*

Phase 3 Integrated Pipeline Pipeline Blow-Off and Air/Vacuum Valve Arrangements

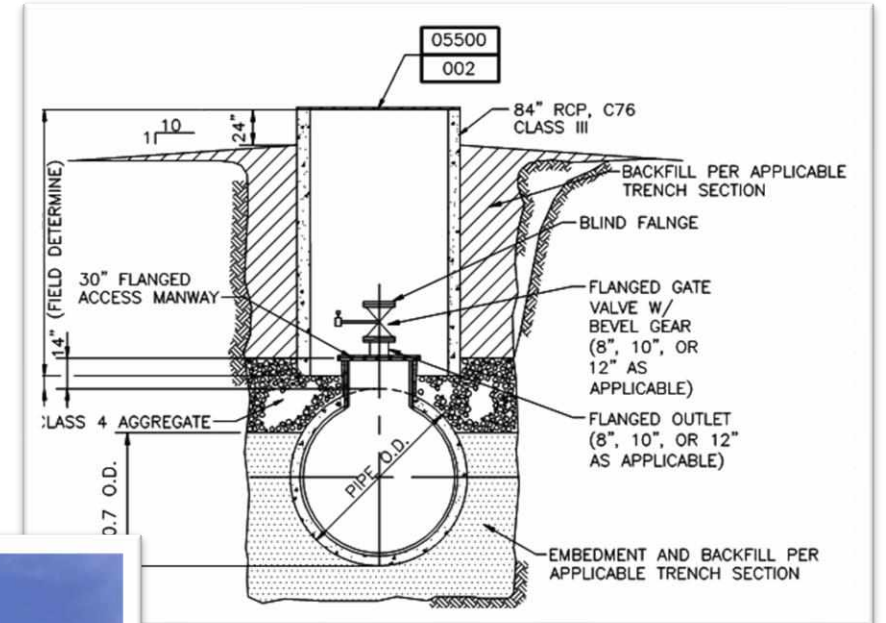
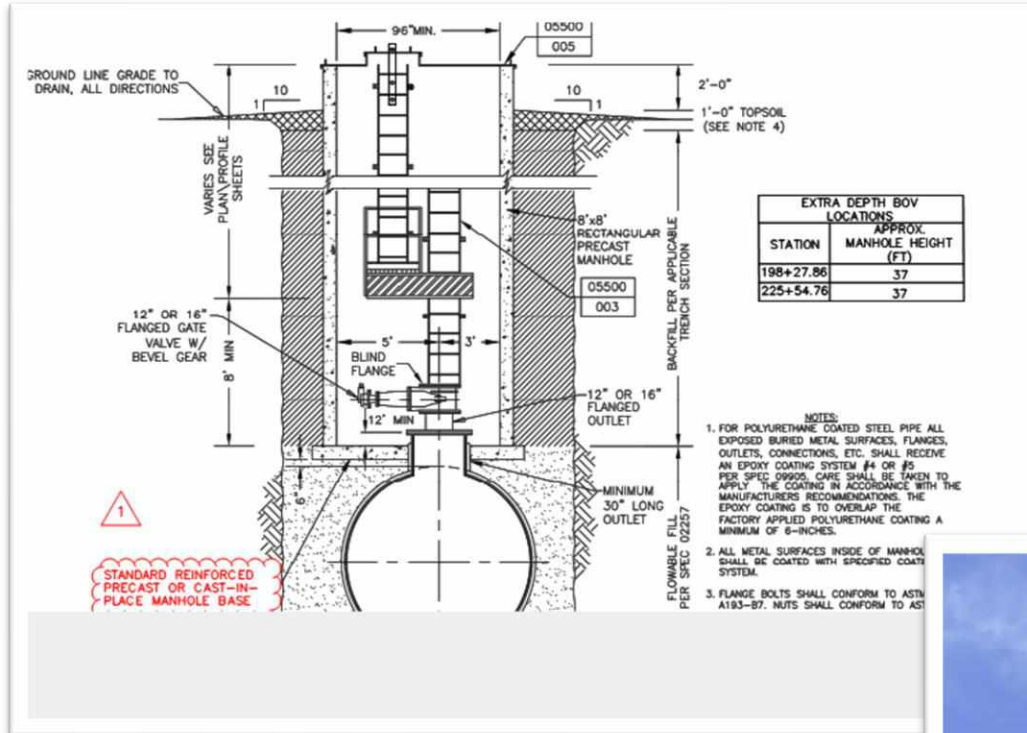

12

Consider Approval of Contract with Garrett Demolition, Inc. for Demolition and Asbestos Abatement of South Bypass Channel-Package 1 for the Central City Flood Control Project

*Kate Beck, Assistant Program Director,
Central City Flood Control Project*



13

Consider Approval of Contract with Cole Construction, Inc. for Upper West Fork Maintenance Road / Trail Replacement

Darrell Beason, *Chief Operations Officer*

Upper West Fork Trail Replacement



14

Consider Approval of Consulting Agreement for Government Affairs

Linda Christie, *Government Affairs Director*

Staff Update

Water Resources Update

Rachel Ickert, Chief Water Resources Officer

Percent of Normal Rainfall



LEGEND

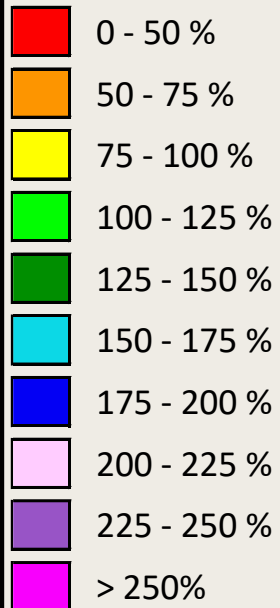

Past 30 Days (4/15/2023 – 5/15/2023)

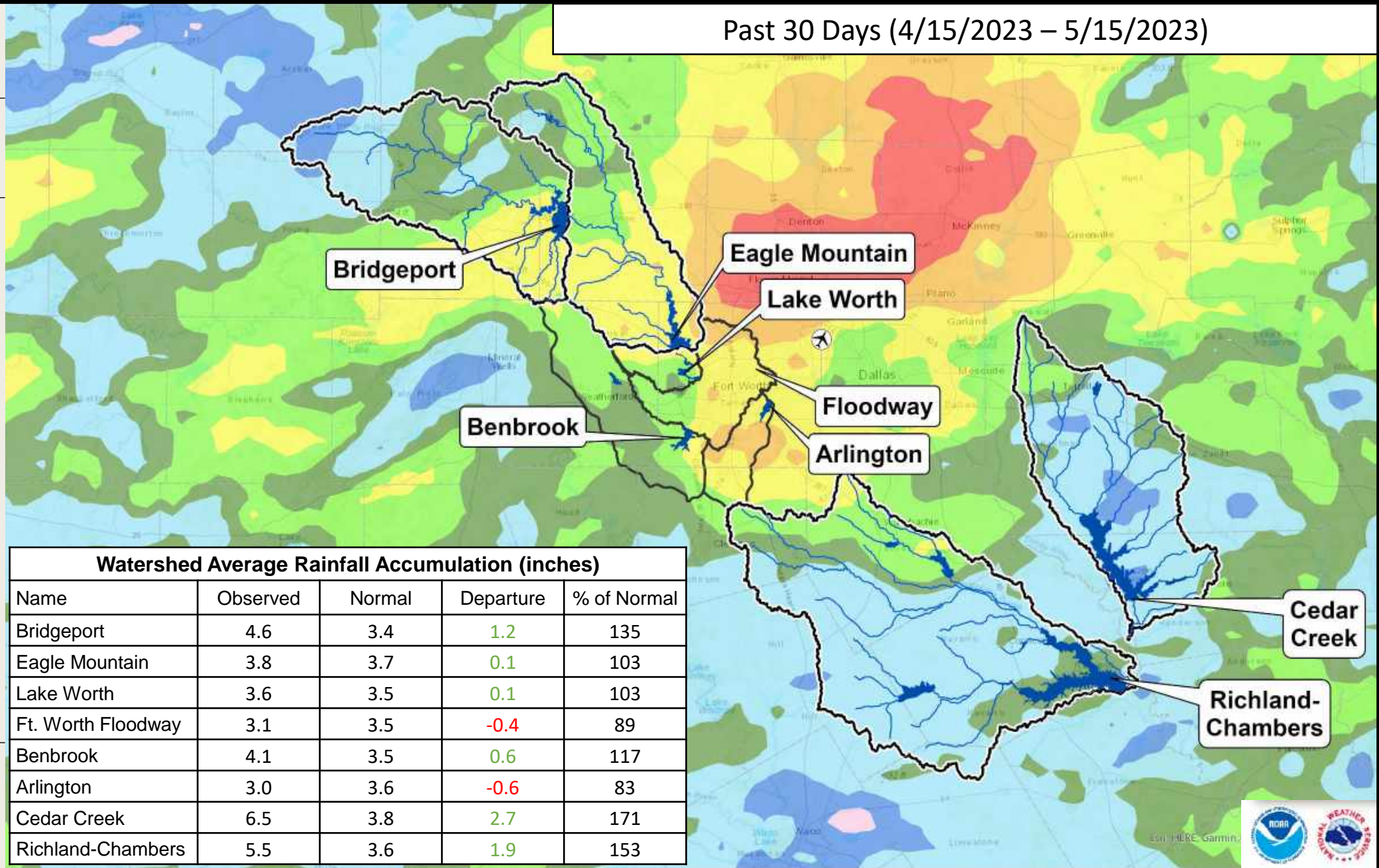

Watershed Average Rainfall Accumulation (inches)				
Name	Observed	Normal	Departure	% of Normal
Bridgeport	4.6	3.4	1.2	135
Eagle Mountain	3.8	3.7	0.1	103
Lake Worth	3.6	3.5	0.1	103
Ft. Worth Floodway	3.1	3.5	-0.4	89
Benbrook	4.1	3.5	0.6	117
Arlington	3.0	3.6	-0.6	83
Cedar Creek	6.5	3.8	2.7	171
Richland-Chambers	5.5	3.6	1.9	153

Precipitation totals are obtained from NOAA's NWS. The totals displayed are estimated by the WGRFC. The data is processed and displayed using ESRI ArcGIS.



Percent of Normal Rainfall



LEGEND

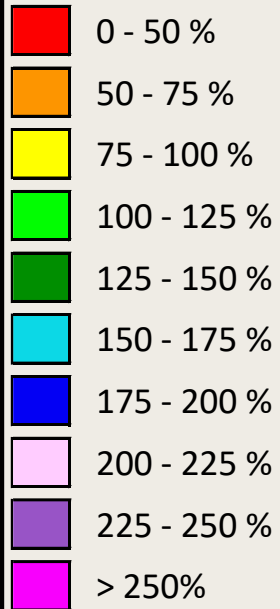

Year to Date (1/1/2023 – 5/15/2023, 135 Days)

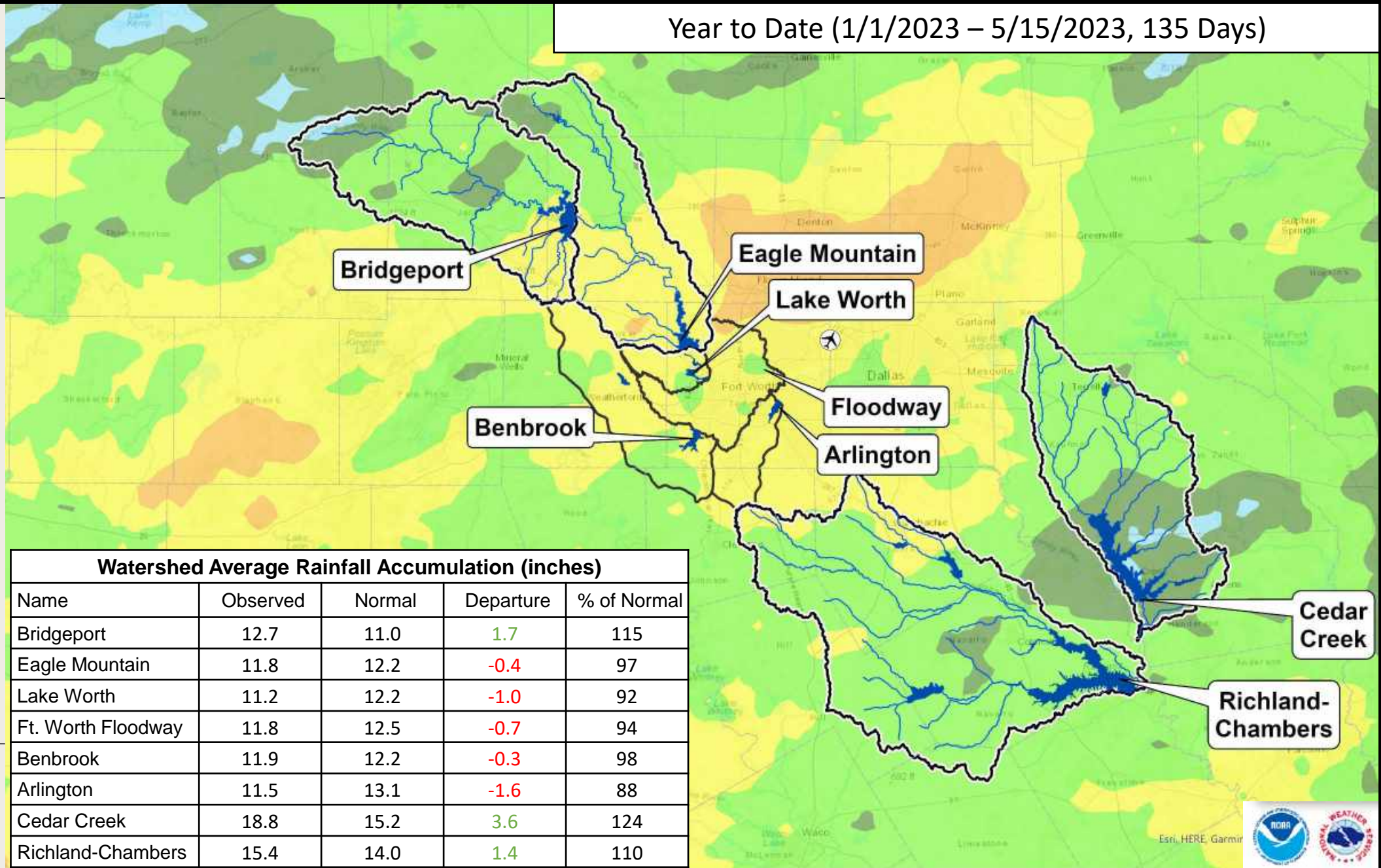

Watershed Average Rainfall Accumulation (inches)				
Name	Observed	Normal	Departure	% of Normal
Bridgeport	12.7	11.0	1.7	115
Eagle Mountain	11.8	12.2	-0.4	97
Lake Worth	11.2	12.2	-1.0	92
Ft. Worth Floodway	11.8	12.5	-0.7	94
Benbrook	11.9	12.2	-0.3	98
Arlington	11.5	13.1	-1.6	88
Cedar Creek	18.8	15.2	3.6	124
Richland-Chambers	15.4	14.0	1.4	110

Precipitation totals are obtained from NOAA's NWS. The totals displayed are estimated by the WGRFC. The data is processed and displayed using ESRI ArcGIS.



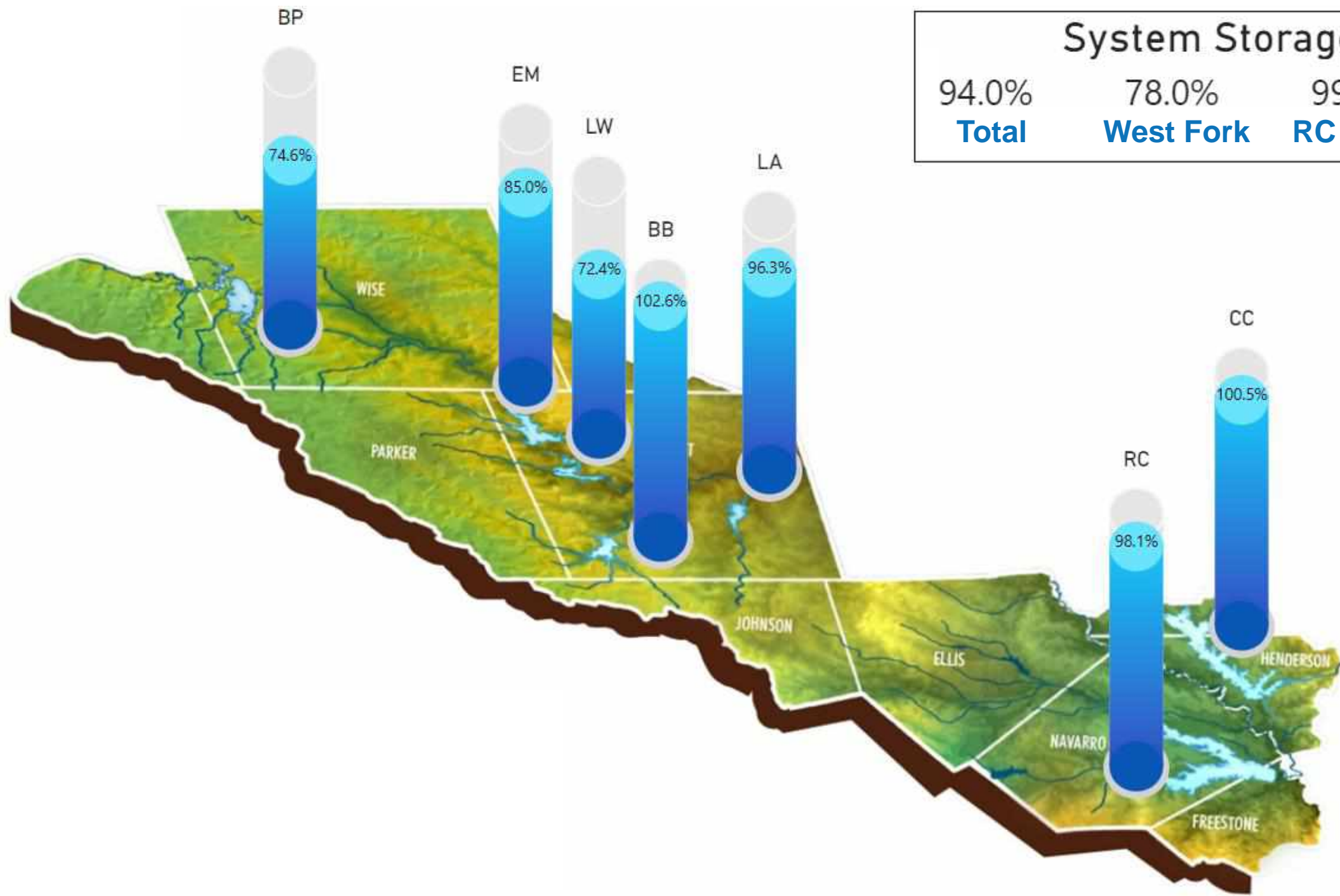

System Storage		
94.0%	78.0%	99.0%
Total	West Fork	RC & CC

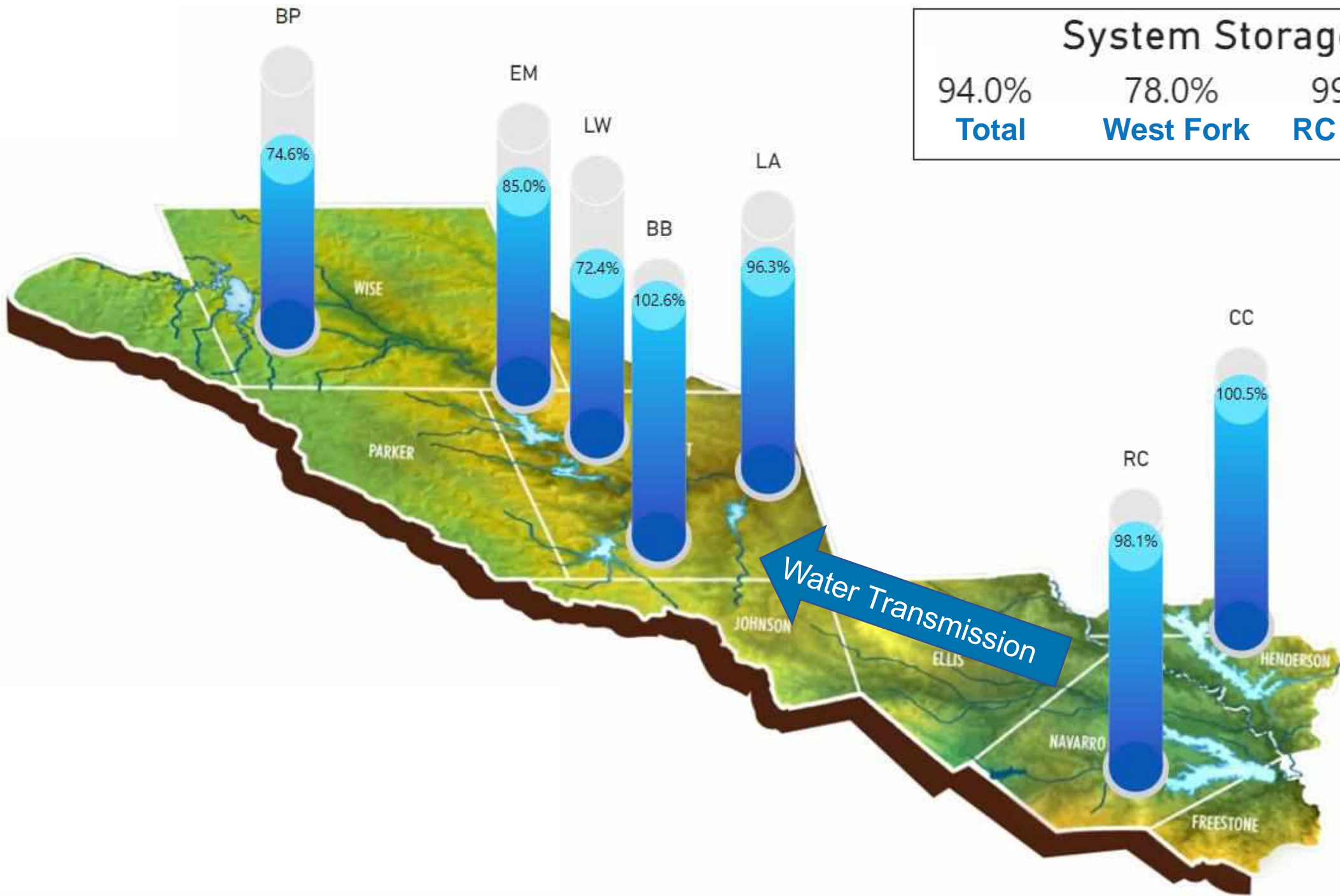

System Storage		
94.0%	78.0%	99.0%
Total	West Fork	RC & CC

Percent of Total Storage on May 15

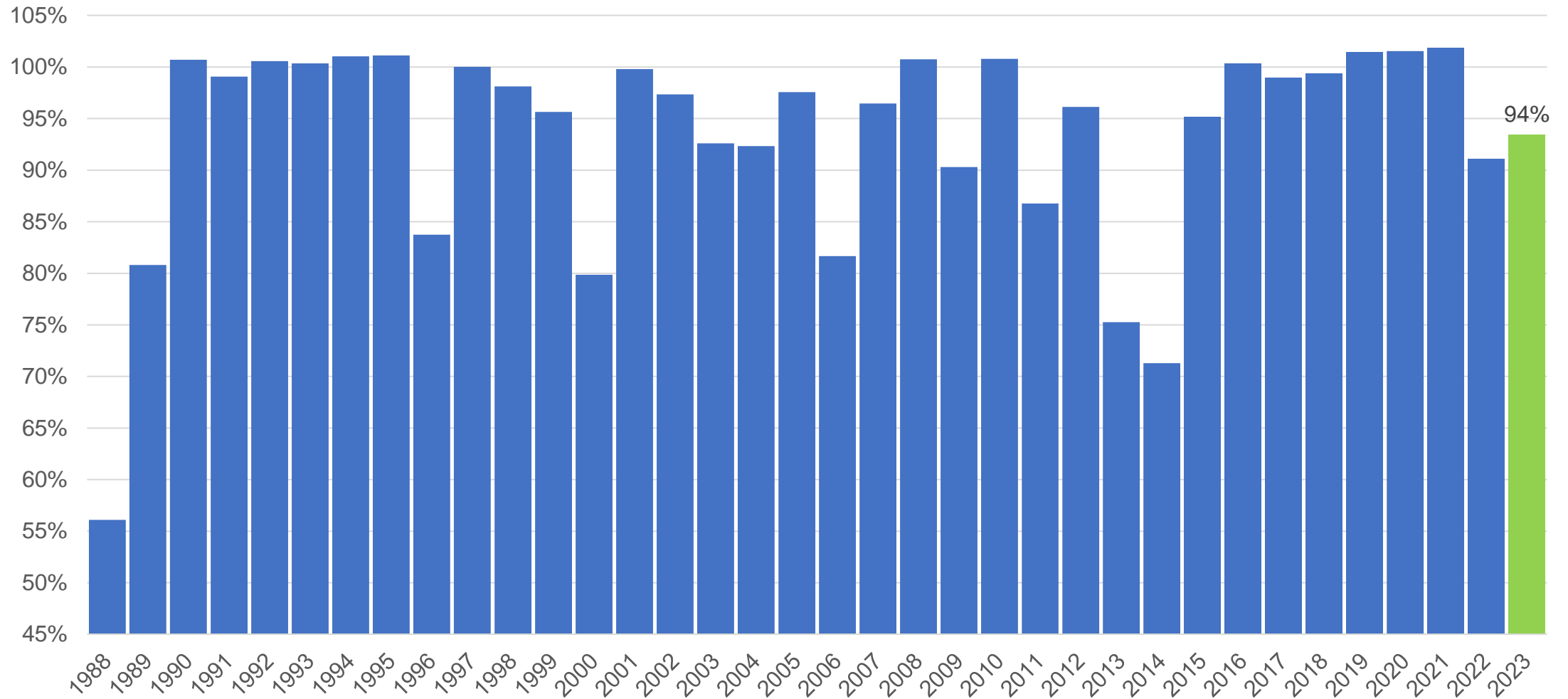

*1988 – All four TRWD reservoirs operational

Percent of West Fork Storage on May 15

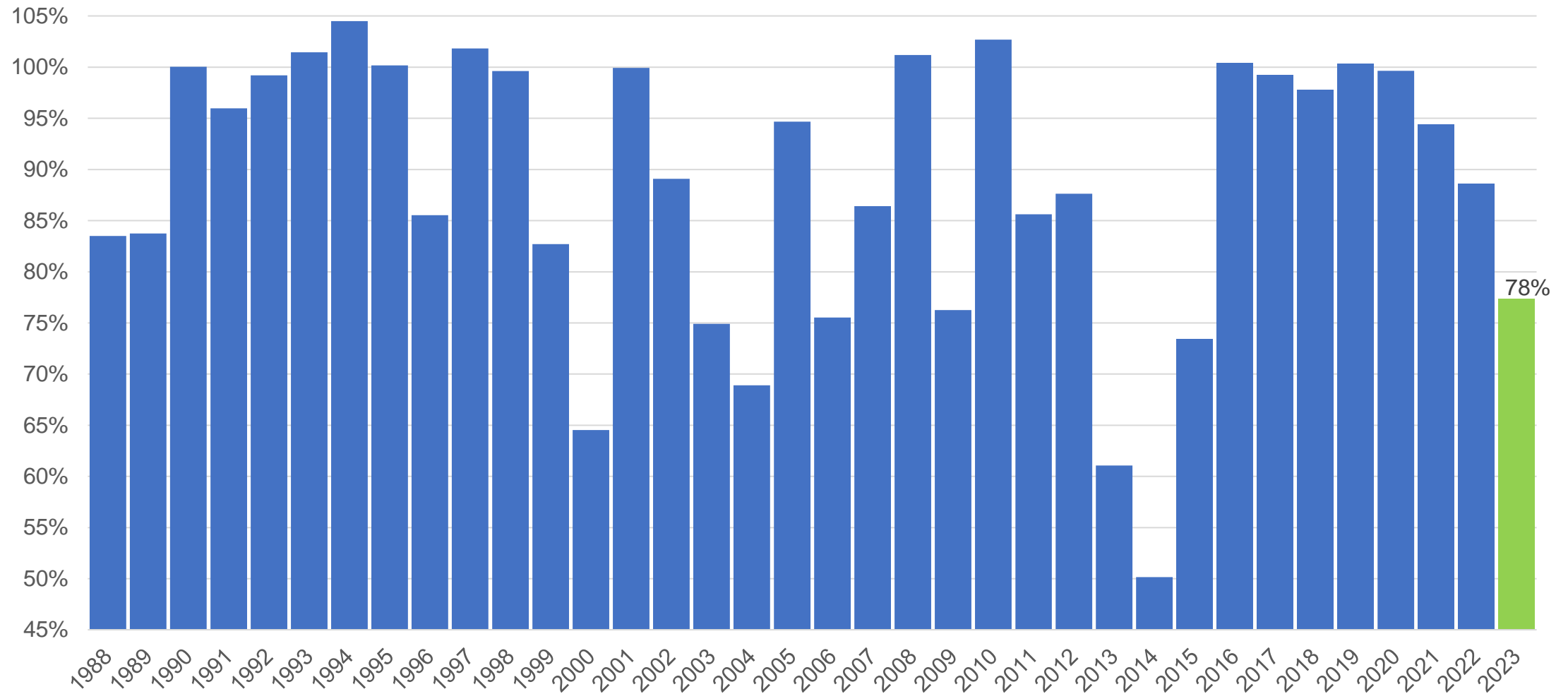

*1988 – All four TRWD reservoirs operational

Historic and Projected Total Water Supply Storage

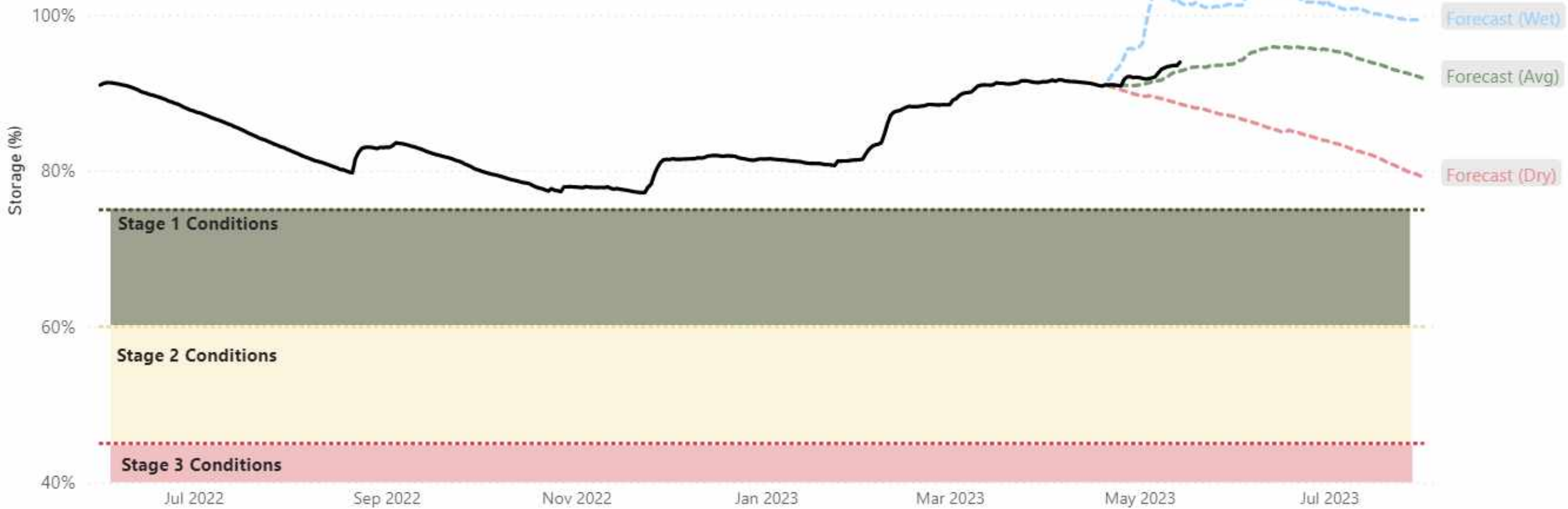

Rainfall Forecast



LEGEND

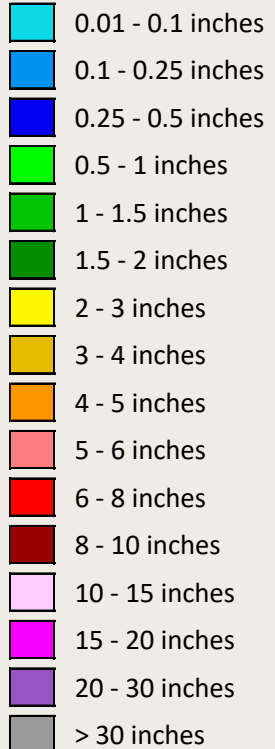

Precipitation forecast is obtained from NOAA's NWS and provided by the Weather Prediction Center (WPC). The data is processed and displayed using USACE Met-Vue software

Note on QPF - QPFs depict the amount of liquid precipitation expected to fall during a specified time period in the future. Because precipitation can vary significantly over short distances, QPFs are reported as the expected "areal average" on a 20-kilometer (12.4 mile) grid. Several factors contribute to QPF estimates, including the current state of the atmosphere, modeled pressure systems, satellite trends, and manual adjustments made by forecasters.

17MAY2023 (WED) - 21MAY2023 (SUN) Duration: 5 Days



Main Takeaway



- *Expect some rain this week.
- *Depths are expected to be low.
- *More of the same next week.
- *Rain is possible, no strong signal of heavy rain.

8 to 14 Day Outlook
Below normal temperatures and slightly above normal rainfall.
(May 22 - May 28)

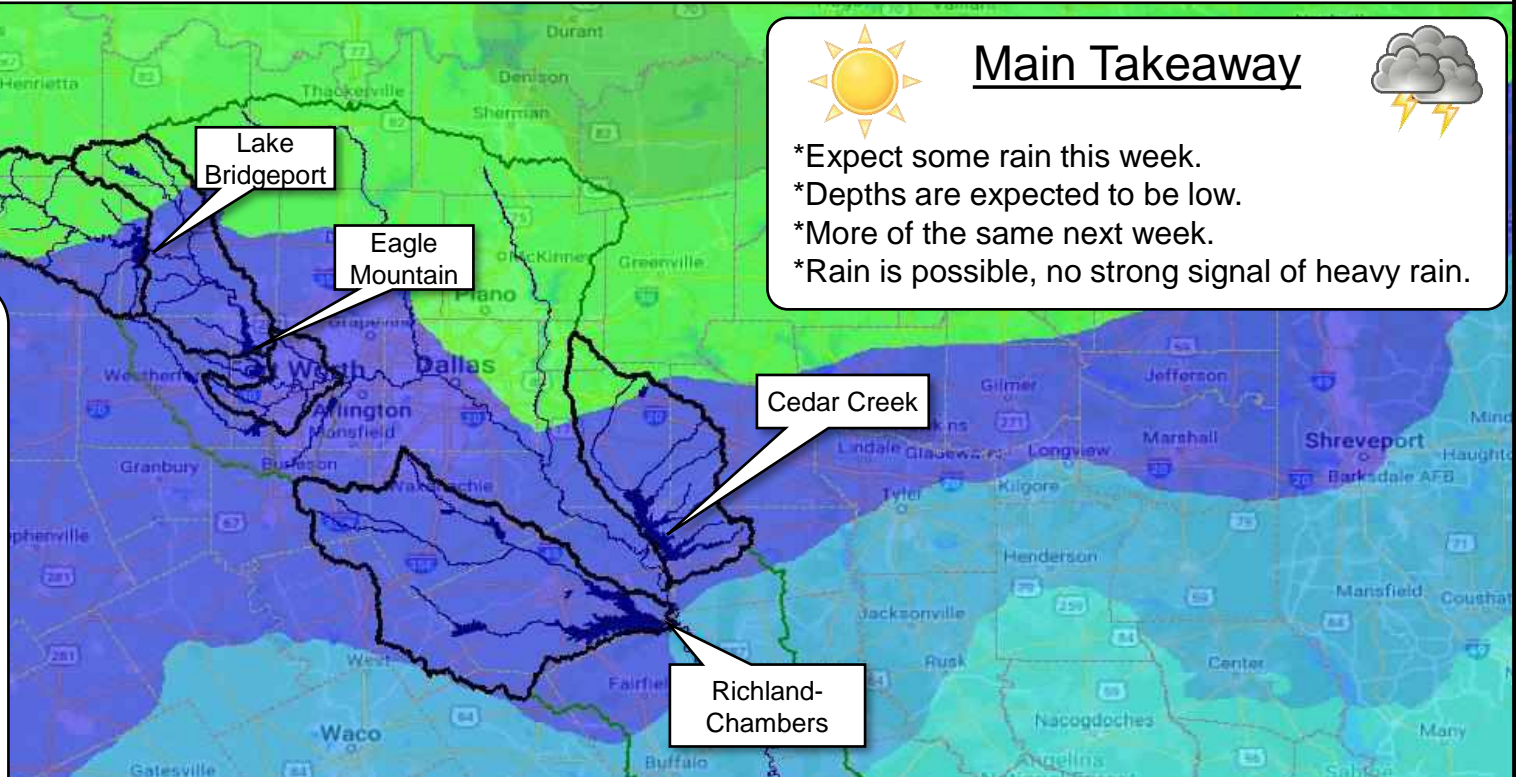
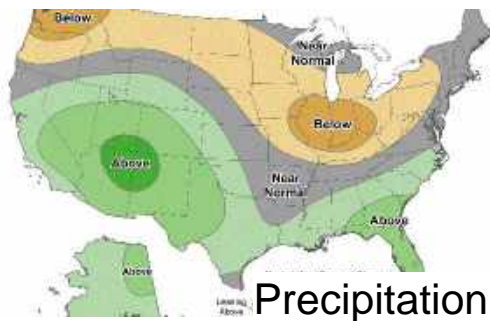
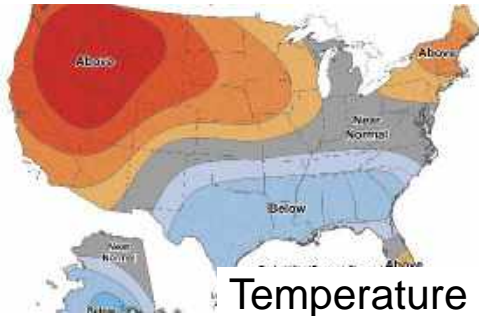

Daily Forecasted Rainfall Totals

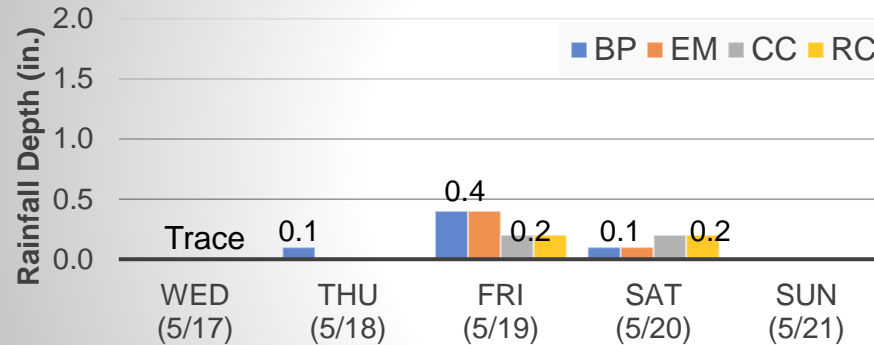

Reservoir	Forecast Total (in.)
BP	0.6
EM	0.5
CC	0.4
RC	0.4

NWS Forecast Time: 2023-05-15 1200 GMT



Staff Update

Fly Fest Update

Darrell Beason, Chief Operations Officer

Stacey Pierce, Executive Director of Streams & Valleys, Inc.

Staff Update

Ubbi Dubbi Update

Darrell Beason, Chief Operations Officer



16

Executive Session

17

Consider Approval of Settlement of Claims in the Integrated Pipeline Project - DTY Ranch LP (733) Lawsuit

Steve Christian, *Real Property Director*



18

Future Agenda Items





19

Next Board Meeting
June 20, 2023 at 9:00 AM





20

Adjourn 