

MINUTES OF A MEETING OF THE BOARD OF DIRECTORS OF
TARRANT REGIONAL WATER DISTRICT
HELD ON THE 21st DAY OF FEBRUARY 2023 AT 9:00 A.M.

The call of the roll disclosed the presence of the Directors as follows:

Present
Leah King
James Hill
Mary Kelleher
Marty Leonard
C.B Team

Also present were Dan Buhman, Alan Thomas, Darrel Andrews, Darrell Beason, Steve Christian, Linda Christie, Ellie Garcia, Jason Gehrig, Zach Hatton, Zachary Huff, Rachel Ickert, Courtney Kelly, Laramie LaRue, Sandy Newby, Nicole Rutigliano, Stephen Tatum, Devin Taylor, and Ed Weaver of the Tarrant Regional Water District (District or TRWD).

1.

All present were given the opportunity to join in reciting the Pledges of Allegiance to the U.S. and Texas flags.

2.

Public comment was received from Doreen Geiger, who spoke regarding item 6, changes to board policies. Public comment was received from Mark Bronson who spoke regarding TRWD support of Save Eagle Mountain Lake (SEML). Public comment was received from Joyce Baker regarding minutes from last meeting on January 17, information regarding candidates for May election, and agenda and meeting date not being officially posted until Monday February 20.

3.

Director Leonard moved to approve the minutes from the meetings held on January 12, 2023 and January 17, 2023. Director Hill seconded the motion, and the votes were 5 in favor, 0 against. It was accordingly ordered that these minutes be placed in the permanent files of the District.

4.

With the recommendation of management, Director Leonard moved to approve the consent agenda which includes human resources expenditures and operations and maintenance expenditures. Consent agenda items are detailed in the attached spreadsheet. Funding for these items is included in the Fiscal Year 2023 General, Revenue, Recreation and Bond Funds. Director Kelleher seconded the motion, and the votes were 5 in favor, 0 against.

Tarrant Regional Water District
February 21, 2023 Board of Directors Meeting
Consent Agenda

HUMAN RESOURCES EXPENDITURES

Project	Vendor	Amount	Purpose	Budget	
1 On-site Biometric Screening Services	Quest Diagnostics	Estimated cost: \$42,040 (based on 325 participants)	Biometric screenings offer employees insight into possible health concerns by providing early detection of issues related to blood pressure, cholesterol, diabetes, and obesity	General	\$75,000
		Total		Total	\$75,000

OPERATIONS AND MAINTENANCE EXPENDITURES

Project	Vendor	Amount	Purpose	Budget	
2 Butterfly valves for the Cedar Creek and Richland-Chambers Pipelines	Crispin Valve	not-to-exceed \$2,359,484	This contract includes manufacturing, assembly, and delivery of three 90-inch diameter and two 102-inch diameter butterfly valves for the Cedar Creek Section II Pipeline Replacement project, and one 90-inch diameter butterfly valve for isolation on the Richland-Chambers Ennis Booster Pump Station Discharge Header Piping.	Bond Fund	
3 Reconciliation Change Order for Joint Cedar Creek Lake Pump Station Package 2, Pump Station and Chemical Feed Facilities Project	BAR Constructors, Inc.	(\$929,108.15)	This change order is for electrical and chemical safety modifications and for unused contract additional unit price bid items, unused extra work items and allowance items remaining.	Bond Fund	
4 Herbicide treatment	Edko, LLC	\$413,791.75	It is the District's goal to eliminate undesirable weeds in the Floodway, Reservoir and Pipeline Systems. This contract shall control unwanted vegetation around all trees, poles, guy wires, structures, rip rap, gates, fences, walkways, paths, and any other protrusions extending from the ground surface within the property boundaries of Tarrant Regional Water District.	General, Revenue, Recreation	817,600
5 Floodway trash removal service	UpSpire / Presbyterian Night Shelter of Tarrant County	\$67,992 for first renewal option	UpSpire / Presbyterian Night Shelter of Tarrant County provides all labor, supervision, material and equipment necessary to remove trash from receptacles and across the Floodway at 19 separate locations. Some locations have a twice-weekly service, while the locations around Marine Creek Reservoir are serviced three times a week.	General	\$68,000
		Total		Total	\$885,600

5.

The Board held a discussion on the proposed TRWD Strategic Plan.

6.

Stephen Tatum, general counsel, reviewed proposed revisions and additions to Board Governance and Purchasing Policies. This item was tabled to allow time for further review.

7.

With the recommendation of counsel, Director Team moved to approve an interlocal agreement between TRWD and City of Fort Worth regarding funding for a Panther Island Development Consultant. The selected consultant will prepare a study which will evaluate development opportunities by reviewing current market conditions, the existing form-based code, and the project's associated plans and regulations. TRWD will contribute up to \$150,000 for the study, and those funds will be matched by City of Fort Worth and Tarrant County. Funding for this item is included in the Fiscal Year 2023 General Fund Budget. Director Hill seconded the motion, and the votes were 5 in favor, 0 against.

8.

With the recommendation of management, Director Leonard moved to approve a resolution to preserve the water quality and open space benefits of its 6.5 acre parcel in the Benbrook watershed until such time as the regional demand for water reaches a level that requires the development of the parcel. Director Hill seconded the motion, and the votes were 5 in favor, 0 against.

9.

With the recommendation of management, Director Kelleher moved to approve an

agreement with RO Two Media, LLC in the amount of \$1,600,000 to develop and manage a comprehensive and effective media campaign for the regional water conservation public awareness campaign, "Water Is Awesome." In accordance with the Memorandum of Understanding with the City of Dallas and North Texas Municipal Water District (NTMWD), Dallas and NTMWD will provide \$900,000 of the regional media purchase expenses. Funding for this item is included in the Fiscal Year 2023 Revenue Fund Budget. Director Hill seconded the motion, and the votes were 5 in favor, 0 against.

10.

With the recommendation of management, Director Kelleher moved to approve an agreement with Glass House Strategy in the amount of \$143,210 to manage and develop new marketing material for the eighth year of the regional water conservation public awareness campaign, "Water Is Awesome." In accordance with the Memorandum of Understanding with the City of Dallas and North Texas Municipal Water District (NTMWD), Dallas and NTMWD will provide \$266,667 of the regional campaign expenses. Since time is of the essence, the Board delegates authority to the General Manager, or designee, to enter into agreements and use budgeted funds for production, media buys, and support services after obtaining approval from the Construction and Operations Committee for services over \$75,000. Funding for this item is included in the Fiscal Year 2023 Revenue Fund Budget. Director Team seconded the motion, and the votes were 5 in favor, 0 against.

11.

With the recommendation of management, Director Hill moved to approve support for a request by Alliance Corridor, Inc., Grantee of Foreign-Trade Zone (FTZ) No. 196,

for a Subzone Expansion Application, specifically Subzone 196A on behalf of TTI, Inc. Director Kelleher seconded the motion, and the votes were 5 in favor, 0 against.

12.

With the recommendation of management, Director Team moved to approve changing the retail electricity provider for 86 non-pump station energy meters from Cavallo Energy to Direct Energy Business. Funding for this item is included in the Fiscal Year 2023 General and Revenue Fund Budgets. Director Hill seconded the motion, and the votes were 5 in favor, 0 against.

13.

With the recommendation of management, Director Kelleher moved to approve a contract amendment in the amount of \$1,237,839 with Black & Veatch Corporation for the design of an additional mile of pipe and upsizing the current design from the S2x12 Interconnect to Mouser Way Road from 90-inch to 102-inch as part of the Cedar Creek Section 2 pipeline replacement project. Funding for this item is included in the Bond Fund. Director Leonard seconded the motion, and the votes were 5 in favor, 0 against.

14.

With the recommendation of management, Director Leonard moved to approve a contract amendment in the amount of \$125,348 with HDR Engineering, Inc. for corrosion control engineering services required for an additional mile of the Cedar Creek and adjacent Richland-Chambers pipeline, and for the upsizing the current design from the S2x12 Interconnect to Mouser Way Road from 90-inch to 102-inch diameter. Funding for this item is included in the Bond Fund. Director Kelleher seconded the motion, and the votes were 4 in favor, 0 against. President King was absent for the vote.

15.

With the recommendation of management, Director Leonard moved to approve a an agreement in an amount not-to-exceed \$2,359,484 with Crispin Valve to manufacture, assemble, and deliver three (3) 90-inch diameter and two (2) 102-inch diameter butterfly valves for the Cedar Creek Section II Pipeline Replacement project, and one (1) 90-inch diameter butterfly valve for isolation on the Richland-Chambers Ennis Booster Pump Station Discharge Header Piping. Funding for this item is included in the Bond Fund. Director Kelleher seconded the motion, and the votes were 5 in favor, 0 against.

16.

With the recommendation of management, Director Leonard moved to approve release of retainage, final payment totaling \$794,871.75, and contract closeout with BAR Constructors, Inc. for Joint Cedar Creek Lake Pump Station Package 2 Pump Station and Chemical Feed Facilities Project of the Integrated Pipeline Project. The General Manager or his designee is granted authority to execute all documents associated with this contract. Funding for this item is included in the Bond Fund. Director Kelleher seconded the motion, and the votes were 5 in favor, 0 against.

17.

With the recommendation of management, Director Team moved to approve a contract in an amount not-to-exceed \$317,700 with Dunaway Associates, L.P. for a Recreation Master Plan for the District's trailheads, parks, recreation facilities, trails and their usage. Funding for this item is included in the Fiscal Year 2023 Recreation Fund Budget. Director Hill seconded the motion, and the votes were 5 in favor, 0 against.

18.

Staff Updates

- Fleet Update presented by Darrell Beason, Chief Operations Officer
- Navarro County Electric Co-Op for Wholesale Power Service Update presented by Stephen Tatum, General Counsel
- Water Resources Update presented by Rachel Ickert, Chief Water Resources Officer

The Board of Directors recessed for a break from 10:41 a.m. to 10:46 a.m.

19.

The Board next held an Executive Session commencing at 10:46 a.m. under Section 551.071 of the Texas Government Code to Consult with Legal Counsel on a Matter in Which the Duty of Counsel Under the Texas Disciplinary Rules of Professional Conduct Clearly Conflicts with Chapter 551, Texas Government Code, and to Discuss Pending or Contemplated Litigation; and Section 551.072 of the Texas Government Code to Deliberate the Purchase, Exchange, Lease or Value of Real Property.

Upon completion of the executive session at 11:05 a.m., the President reopened the meeting.

20.

With the recommendation of management and outside counsel, Director Hill moved to accept from the City of Fort Worth an easement interest in the following described tract, which is necessary for the public use and purpose of construction and operation of the Integrated Pipeline Project (IPL Project).

- **IPL Parcel 1021
(City of Fort Worth)**

A permanent easement across approximately 53.719 acres of land situated in the J.J. Albirado Survey, Abstract Number 4, R.J. Ware Survey, Abstract Number 2008, A. Castello Survey, Abstract Number 272, J. Haynes Survey, Abstract Number 780, T. Moody Survey, Abstract 1070, E. Dishman Survey, Abstract 407, J. Wilcox Survey, Abstract 1743, S.A. & M.G. R.R. Co. Survey, Abstract 1462, and the C. Martin Survey, Abstract 1022, Tarrant County, Texas, and being further described in the accompanying resolution and in the survey plat for Parcel 1021 attached hereto.

EXHIBIT "A"
Property Description

Being 53.719 acres (2,339,998 square feet) of land situated in the J.J. Albirado Survey, Abstract Number 4, R.J. Ware Survey, Abstract Number 2008, A. Castello Survey, Abstract Number 272, J. Haynes Survey, Abstract Number 780, T. Moody Survey, Abstract 1070, E. Dishman Survey, Abstract 407, J. Wilcox Survey, Abstract 1743, S.A. & M.G. R.R. Co. Survey, Abstract 1462, and the C. Martin Survey, Abstract 1022, all in Tarrant County, Texas, being more particularly a portion of that certain right-of-way easement described by deed to City of Fort Worth, recorded in Instrument Number D206245569, Official Public Record, Tarrant County, Texas (O.P.R.T.C.T.), all of that certain right-of-way easement described by deed to City of Fort Worth, A Municipal Corporation, recorded in Instrument Number D206384268, O.P.R.T.C.T., a portion of that certain Final Plat of Summer Creek Drive and McPherson Boulevard Right-of-Way, in the City of Fort Worth, Tarrant County, Texas, recorded in Instrument Number D213105897, O.P.R.T.C.T., a portion of that certain right-of-way dedicated by Final Plat of Summer Creek South, an addition to the City of Fort Worth, Tarrant County, Texas, recorded in Cabinet A, Slide 11030, Plat Records, Tarrant County, Texas (P.R.T.C.T.), Instrument Number D206108553, O.P.R.T.C.T., all of that certain right-of-way dedicated by Final Plat of Summer Creek South, an addition to the City of Fort Worth, Tarrant County, Texas, recorded in Cabinet A, Slide 8806, P.R.T.C.T., Instrument Number D203434631, O.P.R.T.C.T., a portion of that certain plat, West Risinger Road Right-of-Way, in the City of Fort Worth, Tarrant County, Texas, recorded in Cabinet A, Slide 6286, P.R.T.C.T., Instrument Number D200265139, O.P.R.T.C.T., a portion of that certain plat, West Risinger Road and South Hulen Street, an addition to the City of Fort Worth, Tarrant County, Texas, recorded in Volume 388-204, Page 89, P.R.T.C.T., Instrument Number D186045378, O.P.R.T.C.T., a portion of that certain plat of McCart Avenue and West Risinger Road, an addition to the City of Fort Worth, Tarrant County, Texas, recorded in Volume 388-193, Page 98, P.R.T.C.T., a portion of that certain tract of land described by deed to 1419 Illinois Trust, recorded in Instrument Number D220171371, O.P.R.T.C.T., said portion is listed in Exhibit "B" Permitted Exceptions of deed described to previous owner Gutierrez Land Company, LLC, recorded in Instrument Number D220123438, O.P.R.T.C.T. as rights of the public to any portion of land lying within the area commonly known as West Risinger Road, a portion of that certain right-of-way dedicated by plat of Creekside Estates, in Tarrant County, Texas, recorded in Cabinet A, Slide 11604, P.R.T.C.T., Instrument Number D206403335, O.P.R.T.C.T., a portion of that certain tract of land described by deed to City of Fort Worth, A Municipal Corporation, recorded in Instrument Number D216044393, O.P.R.T.C.T., all of that certain right-of-way dedicated by Final Plat of Meadow Creek South, an addition to the City of Fort Worth, Tarrant County, Texas, recorded in Cabinet A, Slide 8822, P.R.T.C.T., Instrument Number D203450603, O.P.R.T.C.T., all of that certain tract of land described by deed to City of Fort Worth, A Municipal Corporation, recorded in Instrument Number D216049351, O.P.R.T.C.T., portion of that certain tract of land described by deed to Atchison Topeka & Santa Fe Railroad, recorded in Volume 34, Page 474, O.P.R.T.C.T. further described by adjoining deeds as Burlington Northern and Santa Fe Railroad (no deed of record listed), a portion of that certain road easement described by deed to Public of Tarrant County, State of Texas, recorded in Volume 5168, Page 278, O.P.R.T.C.T., all of that certain tract of land described by final judgement to City of Fort Worth, A Municipal Corporation, recorded in Instrument Number D218152066, O.P.R.T.C.T., all of that certain tract of land described by deed to City of Fort Worth, A Municipal Corporation, recorded in Instrument Number D217197961, O.P.R.T.C.T., all of that certain tract of land described by judgement in absence of objection to City of Fort Worth, A Municipal Corporation, recorded in Instrument Number D217232139, O.P.R.T.C.T., all of that certain tract of land described by deed to City of Fort Worth, A Municipal Corporation, recorded in Instrument Number D217143589, O.P.R.T.C.T., all of that certain tract of land described by final judgement to City of Fort Worth, A Municipal Corporation, recorded in Instrument Number D217244538, O.P.R.T.C.T., all of that certain tract of land described by deed to City of Fort Worth, A Municipal Corporation, recorded in Instrument Number D216044405, O.P.R.T.C.T., portion of that certain tract of land described by judgement in absence of objection to State of Texas and Tarrant County, Texas, recorded in Volume 9959, Page 605, O.P.R.T.C.T., all of that certain tract of land described by deed to City of Fort Worth, A Municipal Company, recorded in Instrument Number D216185409, O.P.R.T.C.T. corrected in Instrument Number D216240029, O.P.R.T.C.T., a portion of that tract of land described by judgement in absence of objection to State of Texas and Tarrant County, Texas, recorded in Instrument Number D189095915, O.P.R.T.C.T., all of that right-of-way

easement described by deed to Tarrant County, State of Texas, recorded in Volume 4467, Page 826, O.P.R.T.C.T., all of that certain right-of-way easement described by deed to Tarrant County, State of Texas, recorded in Volume 4467, Page 814, O.P.R.T.C.T., all of that certain right-of-way dedicated by plat of South Seminary Addition to the City of Fort Worth, Tarrant County, Texas, recorded in Volume 388-I, Page 33, P.R.T.C.T., all that certain right-of-way easement described by deed to Tarrant County, State of Texas, recorded in Volume 4467, Page 816, O.P.R.T.C.T. and being further described as follows:

BEGINNING at a 5/8 inch iron rod with TranSystems cap found in the north line of said City of Fort Worth right-of-way easement recorded in Instrument Number D206245569, O.P.R.T.C.T. and the south line of Lot 1, Block 1, Final Plat of Life.Church Fort Worth, an addition to the City of Fort Worth, Tarrant County, Texas, recorded in D216190111, O.P.R.T.C.T. and the north right-of-way line of West Risinger Road, a variable width right-of-way, being the **POINT OF BEGINNING** (N: 6,908,622.984, E: 2,304,939.769 Grid), being the beginning of a tangent curve to the left and the northwest corner of herein described tract;

- (1) **THENCE** along said tangent curve to the left, the south line of said Lot 1, the north line of said City of Fort Worth right-of-way easement, said north right-of-way line of West Risinger Road and the north line of herein described tract, an arc length of 135.17 feet, through a central angle of $3^{\circ} 47' 14''$, a radius of 2,045.00 feet, and a chord which bears North $82^{\circ} 19' 53''$ East, a long chord of 135.15 feet to a 1/2 inch iron rod with Weir & Associates cap found;
- (2) **THENCE** North $80^{\circ} 26' 17''$ East, continuing along the south line of said Lot 1, the north line of said City of Fort Worth right-of-way easement, said north right-of-way line of West Risinger Road and the north line of herein described tract, a distance of 31.51 feet to a 1/2 inch iron rod found for the southwest corner of said City of Fort Worth right-of-way easement recorded in Instrument Number D206384268, O.P.R.T.C.T., at the intersection of the north right-of-way line of West Risinger Road and the west right-of-way line of Summer Creek Drive, a variable width right-of-way, being the beginning of a tangent curve to the left;
- (3) **THENCE** along said tangent curve to the left, the south line of said Lot 1, the north line of said City of Fort Worth right-of-way easement, said west right-of-way line of Summer Creek Drive and the north line of herein described tract, an arc length of 94.70 feet, through a central angle of $90^{\circ} 00' 00''$, a radius of 60.29 feet, and a chord which bears North $35^{\circ} 26' 17''$ East, a long chord of 85.26 feet to a 5/8 inch iron rod with TranSystems cap set for the northwest corner of said City of Fort Worth right-of-way easement and an entrant corner of said Lot 1, from which a 5/8 inch iron rod found bears South $78^{\circ} 01' 43''$ West, a distance of 5.14 feet;
- (4) **THENCE** North $80^{\circ} 26' 17''$ East, crossing said Summer Creek Drive, along the north line of said City of Fort Worth right-of-way easement and the north line of herein described tract, a distance of 71.71 feet to a 5/8 inch iron rod with TranSystems cap set for the northeast corner of said City of Fort Worth right-of-way easement, in the west line of right-of-way dedicated by said Final Plat of Summer Creek South, recorded in Instrument Number D206108553, O.P.R.T.C.T.;
- (5) **THENCE** North $63^{\circ} 58' 13''$ East, continuing across said Summer Creek Drive and along the north line of herein described tract, a distance of 62.53 feet to a 5/8 inch iron rod set in the west line of said Final Plat of Summer Creek South, the east line of said right-of-way dedicated by Final Plat of Summer Creek South and said east right-of-way line of Summer Creek Drive, being the beginning of a non-tangent curve to the left;

- (6) **THENCE** along said non-tangent curve to the left, the west line of said Final Plat of Summer Creek South, the east line of right-of-way dedicated by Final Plat of Summer Creek South, said east right-of-way line of Summer Creek Drive and the north line of herein described tract, an arc length of 96.32 feet, through a central angle of $91^{\circ} 58' 53''$, a radius of 60.00 feet, and a chord which bears South $55^{\circ} 33' 48''$ East, a long chord of 86.31 feet to a 5/8 inch iron rod found being the southwest corner of said Final Plat of Summer Creek South, at the intersection of said east right-of-way of Summer Creek Drive and said north right-of-way line of West Risinger Road, being the beginning of a tangent curve to the left;
- (7) **THENCE** along said tangent curve to the left, the south line of said Final Plat of Summer Creek South, the north line of right-of-way dedicated by said Final Plat of Summer Creek South, said north right-of-way line of West Risinger Road and the north line of herein described tract, an arc length of 150.00 feet, through a central angle of $3^{\circ} 51' 27''$, a radius of 2,228.00 feet, and a chord which bears North $76^{\circ} 31' 02''$ East, a long chord of 149.97 feet to a corner, monument unable to be set, being the beginning of a tangent curve to the right;
- (8) **THENCE** along said tangent curve to the right, the south line of said Final Plat of Summer Creek South, the north line of right-of-way dedicated by said Final Plat of Summer Creek South, said north right-of-way line of West Risinger Road and the north line of herein described tract, an arc length of 49.48 feet, through a central angle of $4^{\circ} 38' 51''$, a radius of 610.00 feet, and a chord which bears North $76^{\circ} 54' 44''$ East, a long chord of 49.47 feet to a corner, monument unable to be set, being the beginning of a tangent curve to the left;
- (9) **THENCE** along said tangent curve to the left, the south line of said Final Plat of Summer Creek South, the north line of right-of-way dedicated by said Final Plat of Summer Creek South, said north right-of-way line of West Risinger Road and the north line of herein described tract, an arc length of 183.15 feet, through a central angle of $10^{\circ} 35' 59''$, a radius of 990.00 feet, and a chord which bears North $73^{\circ} 56' 10''$ East, a long chord of 182.89 feet to a 5/8 inch iron rod with TranSystems cap set, being the beginning of a tangent curve to the left;
- (10) **THENCE** along said tangent curve to the left, the south line of said Final Plat of Summer Creek South, the north line of right-of-way dedicated by said Final Plat of Summer Creek South, said north right-of-way line of West Risinger Road and the north line of herein described tract, at an arc length of 191.84 feet passing a 5/8 inch iron rod found, in all an arc length of 206.74 feet, through a central angle of $5^{\circ} 17' 17''$, a radius of 2,240.00 feet, and a chord which bears North $65^{\circ} 59' 32''$ East, a long chord of 206.67 feet to a 5/8 inch iron rod found, being the beginning of a tangent curve to the right;
- (11) **THENCE** along said tangent curve to the right, the south line of said Final Plat of Summer Creek South, the north line of right-of-way dedicated by said Final Plat of Summer Creek South, said north right-of-way line of West Risinger Road and the north line of herein described tract, an arc length of 607.15 feet, through a central angle of $27^{\circ} 17' 03''$, a radius of 1,275.00 feet, and a chord which bears North $76^{\circ} 59' 24''$ East, a long chord of 601.43 to a 1/2 inch iron rod with illegible cap found in the south line of said Final Plat of Summer Creek South recorded in Instrument Number D203434631, O.P.R.T.C.T. and the north line of right-of-way dedicated by the said Final Plat of Summer Creek South;

- (12) **THENCE** South $89^{\circ} 22' 05''$ East, along the south line of said Final Plat of Summer Creek South, the north line of right-of-way dedicated by said Final Plat of Summer Creek South, said north right-of-way line of West Risinger Road and the north line of herein described tract, a distance of 276.79 feet to a 5/8 inch iron rod with TranSystems cap set;
- (13) **THENCE** North $89^{\circ} 02' 30''$ East, along the south line of said Final Plat of Summer Creek South, the north line of right-of-way dedicated by said Final Plat of Summer Creek South, said north right-of-way line of West Risinger Road and the north line of herein described tract, a distance of 881.15 feet to 5/8 inch iron rod with TranSystems cap set in the south line of Summer Creek Ranch, recorded in Cabinet A, Slide 6341, P.R.T.C.T., Instrument Number D200287466, O.P.R.T.C.T. and the north line of said plat called West Risinger Road Right-of-Way, recorded in Cabinet A, Slide 6286, P.R.T.C.T., Instrument Number D200265139, O.P.R.T.C.T., being the beginning of a tangent curve to the left;
- (14) **THENCE** along said tangent curve to the left, the south line of said Summer Creek Ranch, the north line of said plat called West Risinger Road Right-of-Way, said north right-of-way line of West Risinger Road and the north line of herein described tract, at an arc length of 371.38 feet passing a 3/8 inch iron rod found, in all an arc length of 372.71 feet, through a central angle of $3^{\circ} 55' 32''$, a radius of 5,440.00 feet, and a chord which bears North $87^{\circ} 04' 44''$ East, a long chord of 372.64 feet to a 5/8 inch iron rod with TranSystems cap set;
- (15) **THENCE** North $84^{\circ} 41' 42''$ East, crossing said plat called West Risinger Road Right-of-Way, along said north right-of-way line of West Risinger Road and the north line of herein described tract, a distance of 80.00 feet to a corner in the south line of said Summer Creek Ranch and the north line of said plat called West Risinger Road Right-of-Way, being the beginning of a tangent curve to the left from which a 5/8 inch iron rod found bears North $10^{\circ} 42' 23''$ West, a distance of 0.31 feet;
- (16) **THENCE** along said tangent curve to the left and continuing along the south line of said Summer Creek Ranch, the north line of said plat called West Risinger Road Right-of-Way, said north right-of-way line of West Risinger Road and the north line of herein described tract, an arc length of 455.63 feet, through a central angle of $4^{\circ} 47' 56''$, a radius of 5,440.00 feet, and a chord which bears North $81^{\circ} 52' 27''$ East, a long chord of 455.50 feet to a 5/8 inch iron rod with TranSystems cap set in the south line of Summer Creek Ranch, recorded in Cabinet A, Slide 6284, P.R.T.C.T., Instrument Number D200265137 O.P.R.T.C.T.;
- (17) **THENCE** North $79^{\circ} 28' 30''$ East, along the south line of said Summer Creek Ranch, the north line of said plat called West Risinger Road Right-of-Way, said north right-of-way line of West Risinger Road and the north line of herein described tract, a distance of 910.46 feet to a 5/8 inch iron rod with TranSystems cap set, being the beginning of a tangent curve to the right;
- (18) **THENCE** along said tangent curve to the right and continuing along the south line of said Summer Creek Ranch, the north line of said plat called West Risinger Road Right-of-Way, said north right-of-way line of West Risinger Road and the north line of herein described tract, an arc length of 281.13 feet, through a central angle of $6^{\circ} 32' 52''$, a radius of 2,460.00 feet, and a chord which bears North $82^{\circ} 44' 55''$ East, a long chord of 280.98 feet to a 5/8 inch iron rod with TranSystems cap set;

- (19) **THENCE** North $86^{\circ} 49' 30''$ East, crossing said plat called West Risinger Road Right-of-Way, along said north right-of-way line of West Risinger Road and the north line of herein described tract, a distance of 69.99 feet to a 5/8 inch iron rod with TranSystems cap set in the south line of said Summer Creek Ranch and the north line of said plat West Risinger Road Right-of-Way;
- (20) **THENCE** North $87^{\circ} 38' 25''$ East, continuing along the south line of said Summer Creek Ranch, the north line of said plat called West Risinger Road Right-of-Way, said north right-of-way line of West Risinger Road and the north line of herein described tract, a distance of 333.42 feet to a 5/8 inch iron rod set with TranSystems cap set for the southeast corner of said Summer Creek Ranch, the southwest corner of Stone Meadow Commercial Addition, recorded in Cabinet A, Slide 8215, P.R.T.C.T., Instrument Number D203092399, O.P.R.T.C.T., the northeast corner of said plat called West Risinger Road Right-of-Way and the northwest corner of said plat called West Risinger Road and South Hulen Street, being the beginning of a tangent curve to the right;
- (21) **THENCE** along said tangent curve to the right, the south line of said Stone Meadow Commercial Addition, the north line of said plat called West Risinger Road and South Hulen Street, said north right-of-way line of West Risinger Road and the north line of herein described tract, an arc length of 430.15 feet, through a central angle of $2^{\circ} 21' 22''$, a radius of 10,460.00 feet, and a chord which bears North $88^{\circ} 30' 48''$ East, a long chord of 430.12 feet to a 5/8 inch iron rod with TranSystems cap set at the intersection of said north right-of-way line of West Risinger Road and the west right-of-way line of South Hulen Street, a variable width right-of-way, described by said plat called West Risinger Road and South Hulen Street, from which a 5/8 inch iron rod with WAI cap found bears South $80^{\circ} 47' 13''$ East, a distance of 1.32 feet;
- (22) **THENCE** North $87^{\circ} 56' 10''$ East, crossing said plat called West Risinger Road and South Hulen Street, along said north right-of-way line of West Risinger Road and the north line of herein described tract, a distance of 311.37 feet to a 5/8 inch iron rod with TranSystems cap set in the south line of Hulen Meadows, recorded in Cabinet A, Slide 12678, P.R.T.C.T., Instrument Number D208172491, O.P.R.T.C.T., in the north line of said plat called West Risinger Road and South Hulen Street, at the intersection of said north right-of-way line of West Risinger Road and the east right-of-way line of said South Hulen Street;
- (23) **THENCE** South $89^{\circ} 46' 08''$ East, along the south line of said Hulen Meadows, the north line of said plat called West Risinger Road and South Hulen Street, said north right-of-way line of West Risinger Road and the north line of herein described tract, a distance of 220.00 feet to a 5/8 inch iron rod with TranSystems cap set;
- (24) **THENCE** South $86^{\circ} 38' 32''$ East, continuing along the south line of said Hulen Meadows, the north line of said plat called West Risinger Road and South Hulen Street, said north right-of-way line of West Risinger Road and the north line of herein described tract, a distance of 220.00 feet to a 1/2 inch iron rod found;
- (25) **THENCE** South $89^{\circ} 46' 08''$ East, continuing along the south line of said Hulen Meadows, the north line of said plat called West Risinger Road and South Hulen Street, said north right-of-way line of West Risinger Road and the north line of herein described tract, a distance of 555.84 feet to a 5/8" iron rod with TranSystems cap set in the south line of Garden Springs Addition, recorded in Cabinet A, Slide 3157, P.R.T.C.T., Instrument Number D196213689, O.P.R.T.C.T., being the beginning of a tangent curve to the right;

- (26) **THENCE** along said tangent curve to the right, the south line of said Garden Springs Addition, the north line of said plat called West Risinger Road and South Hulen Street, said north right-of-way line of West Risinger Road and the north line of herein described tract, an arc length of 520.97 feet, through a central angle of $15^{\circ} 48' 41''$, a radius of 1,887.85 feet, and a chord which bears South $81^{\circ} 51' 47''$ East, a long chord of 519.32 feet to a 5/8 inch iron rod with TranSystems cap set;
- (27) **THENCE** South $73^{\circ} 11' 20''$ East, crossing said plat called West Risinger Road and South Hulen Street, along said north right-of-way line of West Risinger Road and the north line of herein described tract, a distance of 64.00 feet to a 5/8 inch iron rod with TranSystems cap set in the south line of said Garden Springs Addition and the north line of said plat called West Risinger Road and South Hulen Street;
- (28) **THENCE** South $72^{\circ} 54' 08''$ East, along the south line of said Garden Springs Addition, the north line of said plat called West Risinger Road and South Hulen Street, said north right-of-way line of West Risinger Road and the north line of herein described tract, a distance of 793.78 feet to a 5/8 inch iron rod with TranSystems cap set in the south line of Garden Springs Addition, recorded in Cabinet A, Slide 2620, P.R.T.C.T., Instrument Number D195230316, O.P.R.T.C.T., being the beginning of a tangent curve to the left;
- (29) **THENCE** along said tangent curve to the left, the south line of said Garden Springs Addition, the north line of said plat called West Risinger Road and South Hulen Street, said north right-of-way line of West Risinger Road and the north line of herein described tract, an arc length of 685.01, through a central angle of $10^{\circ} 51' 35''$, a radius of 3,614.09 feet, and a chord which bears South $78^{\circ} 19' 55''$ East, a long chord of 683.98 feet to a 5/8 inch iron rod with TranSystems cap set in the south line of Hulen Meadow Phase Five, recorded in Volume 388-216, Page 25, P.R.T.C.T., Instrument Number D188022227, O.P.R.T.C.T., from which a 5/8 inch iron rod found bears South $14^{\circ} 56' 18''$ East, a distance of 1.01 feet;
- (30) **THENCE** South $83^{\circ} 45' 44''$ East, along the south line of said Hulen Meadow Addition, the north line of said plat called West Risinger Road and South Hulen Street, said north right-of-way line of West Risinger Road and the north line of herein described tract, a distance of 1,486.01 feet, to a 5/8 inch iron rod with TranSystems cap set in the south line of a tract of land described by deed to Daniel H. Zeligson 1982 Trust, the Karen P. Zeligson 1982 Trust, and the Donna J. Trantham 1992 Trust, recorded in Volume 10918, Page 1047, O.P.R.T.C.T. and the north line of plat, McCart Avenue and West Risinger Road, recorded in Volume 388-193, Page 98, P.R.T.C.T., being the beginning of a tangent curve to the right;
- (31) **THENCE** along said tangent curve to the right, the south line of said Zeligson, et al tract, the north line of said plat called McCart Avenue and West Risinger Road, said north right-of-way line of West Risinger Road and the north line of herein described tract, an arc length of 523.95 feet, through a central angle of $6^{\circ} 40' 16''$, a radius of 4,500.00 feet, and a chord which bears South $80^{\circ} 25' 35''$ East, a long chord of 523.65 feet to a 5/8 inch iron rod with TranSystems cap set at the intersection of said north right-of-way line of West Risinger Road and the west right-of-way line of McCart Avenue, described by said plat called McCart Avenue and West Risinger Road, a variable width right-of-way;

- (32) **THENCE** South $77^{\circ} 49' 48''$ East, crossing said plat called McCart Avenue and West Risinger Road, along said north right-of-way line of West Risinger Road and the north line of herein described tract, a distance of 312.55 feet to a corner in the south line of Meadow Creek South, recorded in Cabinet B, Slide 2854, P.R.T.C.T., Instrument Number D204293281, O.P.R.T.C.T. and the north line of said plat McCart Avenue and West Risinger Road, being the beginning of a non-tangent curve to the left, from which a 5/8 inch iron rod found bears South $25^{\circ} 52' 44''$ West, a distance of 0.53 feet;
- (33) **THENCE** along said non-tangent curve to the left, the south line of said Meadow Creek South, the north line of said plat called McCart Avenue and West Risinger Road, said north right-of-way line of West Risinger Road and the north line of herein described tract, an arc length of 199.80 feet, through a central angle of $3^{\circ} 24' 24''$, a radius of 3,360.18 feet, and a chord which bears South $77^{\circ} 51' 55''$ East, a long chord of 199.77 feet to a 5/8 inch iron rod with TranSystems cap set;
- (34) **THENCE** South $79^{\circ} 17' 58''$ East, continuing along the south line of said Meadow Creek South, the north line of said plat called McCart Avenue and West Risinger Road, said north right-of-way line of West Risinger Road and the north line of herein described tract, a distance of 263.78 feet to a 5/8 inch iron rod with RPLS 4151 cap found in the south line of a tract of land described by deed to 1419 Illinois Trust, recorded in Instrument Number D220171371, O.P.R.T.C.T., being the northwest corner of a portion of said 1419 Illinois Trust tract listed in Exhibit "B" Permitted Exceptions of deed described to previous owner Gutierrez Land Company, LLC, recorded in Instrument Number D220123438, O.P.R.T.C.T. as rights of the public to any portion of land lying within the area commonly known as West Risinger Road and being the beginning of a non-tangent curve to the left;
- (35) **THENCE** along said non-tangent curve to the left, the south line of said 1419 Illinois Trust tract, the north line of said area commonly known as West Risinger Road, said north right-of-way line of West Risinger Road and the north line of herein described tract, an arc length of 764.85 feet, through a central angle of $12^{\circ} 59' 44''$, a radius of 3,372.10 feet, and a chord which bears North $89^{\circ} 21' 10''$ East, a long chord of 763.21 feet to a 5/8 inch iron rod with TranSystems cap set in the south line of a tract of land described by deed to McCart-Risinger L.P., recorded in Instrument Number D204331963, O.P.R.T.C.T. and the north line of a tract of land described by deed to City of Fort Worth, a Municipal Corporation, recorded in Instrument Number D216044393, O.P.R.T.C.T., being the beginning of a tangent curve to the right;
- (36) **THENCE** along said tangent curve to the right, the south line of said McCart-Risinger L.P. tract, the north line of said City of Fort Worth tract, said north right-of-way line of West Risinger Road and the north line of herein described tract, an arc length of 574.30 feet, through a central angle of $6^{\circ} 30' 34''$, a radius of 5,055.00 feet, and a chord which bears North $86^{\circ} 06' 34''$ East, a long chord of 573.99 feet to 5/8 inch iron rod with TranSystems cap set;
- (37) **THENCE** North $89^{\circ} 21' 51''$ East, along the south line of said McCart-Risinger L.P. tract, the north line of said City of Fort Worth tract, said north right-of-way line of West Risinger Road and the north line of herein described tract, a distance of 234.19 feet to a 5/8 inch iron rod with TranSystems cap set;
- (38) **THENCE** North $89^{\circ} 23' 57''$ East, crossing said City of Fort Worth tract, along said north right-of-way line of West Risinger Road and the north line of herein described tract, a distance of 79.97 feet to a 5/8 inch iron rod with TranSystems cap set in the south line of said McCart-Risinger L.P. tract and the north line of said City of Fort Worth tract;

- (39) **THENCE** North 89° 22' 46" East, along the south line of said McCart-Risinger L.P. tract, the north line of said City of Fort Worth tract, said north right-of-way line of West Risinger Road and the north line of herein described tract, a distance of 656.20 feet to a 5/8 inch iron rod with TranSystems cap set being the beginning of a tangent curve to the left;
- (40) **THENCE** along said tangent curve to the left, the south line of said McCart-Risinger L.P. tract, the north line of said City of Fort Worth tract, said north right-of-way line of West Risinger Road and the north line of herein described tract, an arc length of 20.69, through a central angle of 0° 14' 23", a radius of 4,945.00 feet, and a chord which bears North 89° 15' 35" East, a long chord of 20.69 feet to a 5/8 inch iron rod with TranSystems cap set;
- (41) **THENCE** North 89° 08' 24" East, along the south line of said McCart-Risinger L.P. tract, the north line of said City of Fort Worth tract, said north right-of-way line of West Risinger Road and the north line of herein described tract, a distance of 60.73 feet to a 5/8 inch iron rod with TranSystems cap set in the west line of right-of-way dedicated by Final Plat of Meadow Creek South, recorded in Cabinet A, Slide 8822, P.R.T.C.T., Instrument Number D203450603, O.P.R.T.C.T. being a southeast corner of said McCart-Risinger L.P. tract and a northerly corner of said City of Fort Worth tract;
- (42) **THENCE** North 0° 49' 17" West, along the east line of said McCart-Risinger L.P. tract, the west line of right-of-way dedicated by said Final Plat of Meadow Creek South, said north right-of-way line of West Risinger Road and the north line of herein described tract, a distance of 5.00 feet to a 5/8 inch iron rod with C&B cap found being the northwest corner of said right-of-way dedicated by Final Plat of Meadow Creek South, the southwest corner of said Final Plat of Meadow Creek South;
- (43) **THENCE** North 89° 08' 47" East, along the south line of said Final Plat of Meadow Creek South, the north line of right-of-way dedicated by said Final Plat of Meadow Creek South, said north right-of-way line of West Risinger Road and the north line of herein described tract, a distance of 1,279.27 feet to a 5/8 inch iron rod found being the southeast corner of a tract of land described by deed to The City of Fort Worth, recorded in Instrument Number D208037608, O.P.R.T.C.T., the northeast corner of right-of-way dedicated by said Final Plat of Meadow Creek South in the west line of Meyer Utility Structures Addition, recorded in Instrument Number D219197514, O.P.R.T.C.T.;
- (44) **THENCE** South 0° 38' 44" East, along the west line of said Meyer Utility Structures Addition, the east line of right-of-way dedicated by said Final Plat of Meadow Creek South, said north right-of-way line of West Risinger Road and the north line of herein described tract, a distance of 4.99 feet to a 5/8 inch iron rod with Gorrodona cap found for the southwest corner of said Meyer Utility Structures Addition and the northwest corner of a tract of land described by deed to City of Fort Worth, a Municipal Corporation, recorded in Instrument Number D216049351, O.P.R.T.C.T.;
- (45) **THENCE** North 89° 45' 07" East, along the south line of said Meyer Utility Structures Addition, the north line of said City of Fort Worth tract, said north right-of-way line of West Risinger Road and the north line of herein described tract, a distance of 754.09 feet to a 5/8 inch iron rod with Gorrodona cap found being the southeast corner of said Meyer Utility Structures Addition, the northeast corner of said City of Fort Worth tract, in the west line of a tract of land called Burlington Northern and Santa Fe Railroad (BNSF), no deed of record found;

- (46) **THENCE** North $89^{\circ} 49' 08''$ East, crossing said BNSF tract, along said north right-of-way line of West Risinger Road and the north line of herein described tract, a distance of 100.04 feet to a 5/8 inch iron rod with Gorrondona cap found being the southwest corner of the remainder of a tract of land described by deed to Southwest Metal Treating Corporation, LLC, recorded in Instrument Number D210264416, O.P.R.T.C.T. and the northwest corner of a tract of land described by deed to City of Fort Worth, a Municipal Corporation, recorded in Instrument Number D218152066, O.P.R.T.C.T.;
- (47) **THENCE** North $89^{\circ} 45' 37''$ East, along the south line of said Southwest Metal Treating Corporation tract, the north line of said City of Fort Worth tract, said north right-of-way line of West Risinger Road and the north line of herein described tract, a distance of 7.97 feet to a 5/8 inch iron rod with TranSystems cap set, being the beginning of a tangent curve to the right;
- (48) **THENCE** along said tangent curve to the right, the south line of said Southwest Metal Treating Corporation tract, the north line of said City of Fort Worth tract, said north right-of-way line of West Risinger Road and the north line of herein described tract, an arc length of 357.28 feet, through a central angle of $16^{\circ} 18' 40''$, a radius of 1,255.00 feet, and a chord which bears South $82^{\circ} 05' 03''$ East, a long chord of 356.07 feet to a PK nail with washer stamped Gorrondona found, being the southeast corner of said City of Fort Worth tract in the north line of said road easement dedicated to the Public of Tarrant County, State of Texas, recorded in Volume 5168, Page 278, O.P.R.T.C.T.;
- (49) **THENCE** North $89^{\circ} 06' 35''$ East, along the south line of said Southwest Metal Treating Corporation tract, the north line of said Public road easement, said north right-of-way line of West Risinger Road and the north line of herein described tract, a distance of 160.60 feet to a PK nail with washer stamped Gorrondona found, being the southeast corner of said Metal Treating Corporation tract, a northeast corner of said Public road easement in the west line of Gibbs Industrial Addition, recorded in Instrument Number D201018221, O.P.R.T.C.T.;
- (50) **THENCE** South $0^{\circ} 47' 21''$ East, along the west line of said Gibbs Industrial Addition, an easterly line of said Public road easement, said north right-of-way line of West Risinger Road and the north line of herein described tract, a distance of 60.21 feet to a PK nail with washer stamped Gorrondona found, being the southwest corner of the remainder of a tract of land described by deed to Thomas D. Gibbs, recorded in Instrument Number D200111309, O.P.R.T.C.T. and the northwest corner of a tract of land described by deed to City of Fort Worth, a Municipal Corporation, recorded in Instrument Number D217232139, O.P.R.T.C.T.;
- (51) **THENCE** South $68^{\circ} 18' 52''$ East, along the south line of said Gibbs tract, the north line of said City of Fort Worth tract, said north right-of-way line of West Risinger Road and the north line of herein described tract, a distance of 102.97 feet to a PK nail with washer stamped Gorrondona found, being the beginning of a tangent curve to the left;

- (52) **THENCE** along said tangent curve to the left, continuing along the south line of said Gibbs tract, the north line of said City of Fort Worth tract, said north right-of-way line of West Risinger Road and the north line of herein described tract, an arc length of 439.41 feet, through a central angle of $21^{\circ} 59' 18''$, a radius of 1,145.00 feet, and a chord which bears South $79^{\circ} 18' 31''$ East, a long chord of 436.72 feet to a 5/8 inch iron rod with TranSystems cap set in the south line of the remainder of a tract of land described by deed to Michael William Hawkins, recorded in Instrument Number D216175289, O.P.R.T.C.T., and the north line of a tract of land described by deed to City of Fort Worth, a Municipal Corporation, recorded in Instrument Number D217244538, O.P.R.T.C.T.;
- (53) **THENCE** North $89^{\circ} 41' 50''$ East, along the south line of said Hawkins tract, the north line of said City of Fort Worth tract, said north right-of-way line of West Risinger Road and the north line of herein described tract, a distance of 337.49 feet to a 5/8 inch iron rod with TranSystems cap set, being the southeast corner of said Hawkins tract, the northeast corner of said City of Fort Worth tract at the intersection of said north right-of-way line of West Risinger Road and the west right-of-way line of FM 731, a variable width right-of-way;
- (54) **THENCE** North $88^{\circ} 54' 15''$ East, crossing said FM 731, along said north right-of-way line of West Risinger Road and the north line of herein described tract, a distance of 236.67 feet to a 1/2 inch iron rod with YP Associates cap found, being the southeast corner of a tract of land described by said judgement in absence of objection to State of Texas and Tarrant County, Texas recorded in Instrument Number D189095915, O.P.R.T.C.T., the southwest corner of Final Plat of Lot 1, Block A Crowley Road Addition, recorded in Instrument D218178422, O.P.R.T.C.T. in the north line of a right-of-way easement described by deed to Tarrant County, State of Texas, recorded in Volume 4467, Page 826, O.P.R.T.C.T.;
- (55) **THENCE** North $89^{\circ} 42' 13''$ East, along the south line of said Lot 1, the north line of said Tarrant County tract, said north right-of-way line of West Risinger Road and the north line of herein described tract, a distance of 316.07 feet to a 5/8 inch iron rod with TranSystems cap set in the west line of a right-of-way dedicated by said South Seminary Addition, recorded in Volume 388-I, Page 33, P.R.T.C.T. and the east right-of-way line of Crowley Road, a variable width right-of-way;
- (56) **THENCE** North $0^{\circ} 37' 42''$ West, along the west line of right-of-way dedicated by said South Seminary Addition, said east right-of-way line of Crowley Road, said north right-of-way line of West Risinger Road and the north line of herein described tract, a distance of 6.14 feet to the southwest corner of said South Seminary Addition and the northwest corner of right-of-way dedicated by said South Seminary Addition, from which a 5/8 inch iron rod with Topographic cap bears S $14^{\circ} 17' 31''$ E, a distance of 0.55 feet;
- (57) **THENCE** North $89^{\circ} 41' 48''$ East, along the south line of said South Seminary Addition, north line of right-of-way dedicated by said South Seminary Addition, said north right-of-way line of West Risinger Road and the north line of herein described tract, a distance of 1,774.15 feet to a 5/8 inch iron rod with TranSystems cap set, being the southeast corner of said South Seminary Addition and the northeast corner of said right-of-way dedicated by said plat in the west line of a tract of land described by deed to Christopher R. Wilshire, recorded in Instrument Number D214106604, O.P.R.T.C.T.;

- (58) **THENCE** South 0° 26' 12" East, along the west line of said Wilshire tract, the east line of right-of-way dedicated by said South Seminary Addition, said north right-of-way line of West Risinger Road and the north line of herein described tract, a distance of 11.37 feet to a 1/2 inch iron rod found with illegible cap being the southwest corner of said Wilshire tract and the northwest corner of said right-of-way easement described by deed to Tarrant County, State of Texas, recorded in Volume 4467, Page 816, O.P.R.T.C.T.;
- (59) **THENCE** North 89° 47' 14" East, along the south line of said Wilshire tract, the north line of said right-of-way easement, said north right-of-way line of West Risinger Road and the north line of herein described tract, a distance of 250.05 feet to a 5/8 inch iron rod with TranSystems cap set being the southeast corner of said Wilshire tract, the northeast corner of said right-of-way easement and the northeast corner of herein described tract in west line of a tract of land described by deed to Willshire Farm, LLC, recorded in Instrument Number D214099817, O.P.R.T.C.T.;
- (60) **THENCE** South 3° 05' 10" East, along the west line of said Willshire Farm tract, the east line of said right-of-way easement and the east line of herein described tract, a distance of 30.66 feet, to a PK nail set in the north line of a tract of land described by deed to Crowley Independent School District (ISD), recorded in Instrument Number D206387276, O.P.R.T.C.T. and the south right-of-way line of West Risinger Road being the southeast corner of herein described tract;
- (61) **THENCE** South 89° 54' 43" West, along the north line of said Crowley ISD tract, said south right-of-way line of West Risinger Road and the south line of herein described tract, a distance of 344.10 feet to a PK nail found, being a northwesterly corner of said Crowley ISD;
- (62) **THENCE** South 0° 01' 16" East, along the westerly line of said Crowley ISD tract, said south right-of-way line of West Risinger Road and the south line of herein described tract, a distance of 26.63 feet to 5/8 inch iron rod with TranSystems cap set, being an entrant corner of said Crowley ISD tract and the southeast corner of a right-of-way easement described by deed to Tarrant County, State of Texas, recorded in Volume 4467, Page 814, O.P.R.T.C.T. from which a 5/8 inch iron rod with TNP cap bears North 78° 37' 44" East, a distance of 1.64 feet;
- (63) **THENCE** South 89° 35' 11" West, along the north line of said Crowley ISD tract, the south line of said right-of-way easement, said south right-of-way line of West Risinger Road and the south line of herein described tract, a distance of 1,636.23 feet to a 5/8 inch iron rod with TranSystems cap set, being a northwesterly corner of the remainder of a tract of land described by deed to B.N. Development Company, Inc., recorded in Instrument Number D206387272, O.P.R.T.C.T. and the northeast corner of a tract of land described by deed to City of Fort Worth, a Municipal Company, recorded in Instrument Number D216240029, O.P.R.T.C.T.;
- (64) **THENCE** South 0° 24' 02" East, along the westerly line of said B.N. Development tract, the east line of said City of Fort Worth tract, said south right-of-way line of West Risinger Road and the south line of herein described tract, a distance of 48.24 feet to a 5/8 inch iron rod with Gorrondona cap found, being an entrant corner of said B.N. Development tract and the southeast corner of said City of Fort Worth tract;
- (65) **THENCE** South 89° 41' 12" West, along the north line of said B.N. Development tract, the south line of said City of Fort Worth tract, said south right-of-way line of West Risinger Road and the south line of herein described tract, a distance of 397.03 feet to a 5/8 inch iron rod with Gorrondona cap found;

- (66) **THENCE** South $74^{\circ} 37' 42''$ West, continuing along the north line of said B.N. Development tract, the south line of said City of Fort Worth tract, said south right-of-way line of West Risinger Road and the south line of herein described tract, a distance of 80.10 feet to the northwest corner of said B.N. Development tract and the southwest corner of said City of Fort Worth tract in the east line of a tract of land described by judgement in absence of objection to State of Texas and Tarrant County, Texas, recorded in Volume 9959, Page 605, O.P.R.T.C.T. as shown in TxDOT Right-of-Way Maps, being the east line of said FM 731, from which a 5/8 inch iron rod found bears South $11^{\circ} 51' 25''$ West, a distance of 0.67 feet;
- (67) **THENCE** North $85^{\circ} 02' 48''$ West, crossing FM 731, along said south right-of-way line of West Risinger Road and the south line of herein described tract, a distance of 225.27 feet to a 5/8 inch iron rod with illegible cap found, being the northeast corner of Tract I described by deed to Allan S. Baumgardner, Sr. and Judy A. Baumgardner, recorded in Volume 14124, Page 371 and Instrument Number D199299231, O.P.R.T.C.T. and the southeast corner of a tract of land described by deed to City of Fort Worth, a Municipal Corporation, recorded in Instrument Number D216044405, O.P.R.T.C.T. in the west line of said FM 731;
- (68) **THENCE** South $89^{\circ} 41' 50''$ West, along the north line of said Baumgardner tract, the south line of said City of Fort Worth tract, said south right-of-way of West Risinger Road and the south line of herein described tract, a distance of 236.81 feet to a PK nail with washer stamped Gorrondona found, being the beginning of a tangent curve to the right;
- (69) **THENCE** along said tangent curve to the right, the north line of said Baumgardner tract, the south line of said City of Fort Worth tract, said south right-of-way of West Risinger Road and the south line of herein described tract, an arc length of 334.97 feet, through a central angle of $15^{\circ} 17' 34''$, a radius of 1,255.00 feet, and a chord which bears North $82^{\circ} 39' 23''$ West, a long chord of 333.98 feet to a 5/8 inch iron rod with Gorrondona cap found being the northwest corner of a tract of land described by deed to City of Fort Worth, a Municipal Corporation, recorded in Instrument Number D217143589, O.P.R.T.C.T., in the north line of a tract of land described by deed to Pedro Herrera and Norma Herrera, recorded in Instrument Number D209236836, O.P.R.T.C.T. and the south line of said road easement dedicated to the Public, recorded in Volume 5168, Page 278, O.P.R.T.C.T.;
- (70) **THENCE** South $89^{\circ} 06' 11''$ West, along the north line of said Herrera tract, the south line of said Public road easement, said south right-of-way line of West Risinger Road and the south line of herein described tract, a distance of 179.75 feet to a 3/4 inch iron rod found;
- (71) **THENCE** North $47^{\circ} 13' 49''$ West, continuing along the north line of said Herrera tract, the south line of said Public road easement, said south right-of-way line of West Risinger Road and the south line of herein described tract, a distance of 48.90 feet to a 5/8 inch iron rod with TranSystems cap set in the east line of the remainder of a tract of land described by deed to 2201 Risinger LLC, recorded in Instrument Number D209049450, O.P.R.T.C.T.;
- (72) **THENCE** North $0^{\circ} 49' 38''$ West, along the east line of said 2201 Risinger tract, the south line of said Public road easement, said south right-of-way line of West Risinger Road and the south line of herein described tract, a distance of 46.41 feet to a 1/2 inch iron rod with red illegible cap found, being the northeast corner of said 2201 Risinger tract and the southeast corner of a tract of land described by deed to City of Fort Worth, a Municipal Corporation, recorded in Instrument Number D217197961, O.P.R.T.C.T.;

- (73) **THENCE** North $68^{\circ} 18' 50''$ West, along the north line of said 2201 Risinger tract, the south line of said City of Fort Worth tract, said south right-of-way line of West Risinger Road and the south line of herein described tract, a distance of 68.46 feet to a 1/2 inch iron rod with Topographic cap found, being the beginning of a tangent curve to the left;
- (74) **THENCE** along said tangent curve to the left, the north line of said 2201 Risinger tract, the south line of said City of Fort Worth tract, said south right-of-way line of West Risinger Road and the south line of herein described tract, an arc length of 438.16 feet, through a central angle of $21^{\circ} 55' 31''$, a radius of 1145.00 feet, and a chord which bears North $79^{\circ} 16' 38''$ West, a long chord of 435.49 feet to a 5/8 inch iron rod found;
- (75) **THENCE** South $89^{\circ} 45' 37''$ West, continuing along the north line of said 2201 Risinger tract, the south line of said City of Fort Worth tract, said south right-of-way line of West Risinger Road and the south line of herein described tract, a distance of 11.16 feet to a 5/8 inch iron rod with Gorrondona cap found, being the northwest corner of said 2201 Risinger tract and the southwest corner of said City of Fort Worth tract, in the east line of said BNSF tract;
- (76) **THENCE** South $89^{\circ} 49' 14''$ West, crossing said BNSF tract, along said south right-of-way of West Risinger Road and the south line of herein described tract, a distance of 99.96 feet to a 5/8 inch iron rod with Gorrondona cap found, being the northeast corner of said McCart-Risinger L.P. tract recorded in Instrument Number D204331963, O.P.R.T.C.T. and the southeast corner of said City of Fort Worth tract recorded in Instrument Number D216044393, O.P.R.T.C.T. in the west line of said BNSF tract;
- (77) **THENCE** South $89^{\circ} 45' 40''$ West, along the north line of said McCart-Risinger L.P. tract, the south line of said City of Fort Worth tract, said south right-of-way line of West Risinger Road and the south line of herein described tract, a distance of 724.07 to a 5/8 inch iron rod with TranSystems cap set, being the beginning of a tangent curve to the left;
- (78) **THENCE** along said tangent curve to the left, the north line of said McCart-Risinger L.P. tract, the south line of said City of Fort Worth tract, said south right-of-way line of West Risinger Road and the south line of herein described tract, an arc length of 53.63 feet, through a central angle of $0^{\circ} 37' 17''$, a radius of 4,945.00 feet, and a chord which bears South $89^{\circ} 27' 02''$ West, a long chord of 53.63 feet to a 5/8 inch iron rod with TranSystems cap set;
- (79) **THENCE** South $89^{\circ} 08' 24''$ West, continuing along the north line of said McCart-Risinger L.P. tract, the south line of said City of Fort Worth tract, said south right-of-way line of West Risinger Road and the south line of herein described tract, a distance of 1,312.07 feet to a 5/8 inch iron rod with TranSystems cap set, being the beginning of a tangent curve to the right;
- (80) **THENCE** along said tangent curve to the right, the north line of said McCart-Risinger L.P. tract, the south line of said City of Fort Worth tract, said south right-of-way line of West Risinger Road and the south line of herein described tract, an arc length of 21.15 feet, through a central angle of $0^{\circ} 14' 23''$, a radius of 5,055.00 feet, and a chord which bears South $89^{\circ} 15' 35''$ West, a long chord of 21.15 feet to a 5/8 inch iron rod with TranSystems cap set;

- (81) **THENCE** South $89^{\circ} 22' 46''$ West, continuing along the north line of said McCart-Risinger L.P. tract, the south line of said City of Fort Worth tract, said south right-of-way line of West Risinger Road and the south line of herein described tract, a distance of 656.20 feet to an "X" cut found being a northwesterly corner of Creekside Estates, recorded in Instrument Number D217184995, O.P.R.T.C.T.;
- (82) **THENCE** South $89^{\circ} 24' 09''$ West, crossing a portion of said City of Fort Worth tract, along said south right-of-way line of West Risinger Road and the south line of herein described tract, a distance of 80.03 feet to a 5/8 inch iron rod with Dunaway cap found being a northeasterly corner of said Creekside Estates in the south line of said City of Fort Worth tract;
- (83) **THENCE** South $89^{\circ} 21' 51''$ West, along the north line of said Creekside Estates, the south line of said City of Fort Worth tract, said south right-of-way line of West Risinger Road and the south line of herein described tract, a distance of 149.56 feet to a 5/8 inch iron rod with Dunaway cap found in the north line of Creekside Estates, recorded in Cabinet A, Slide 11604, P.R.T.C.T., Instrument Number D206403335, O.P.R.T.C.T. and the south line of right-of-way dedicated by said Creekside Estates, being the beginning of a tangent curve to the left;
- (84) **THENCE** along said tangent curve to the left, the north line of said Creekside Estates, the south line of right-of-way dedicated by said Creekside Estates, said south right-of-way line of West Risinger Road and the south line of herein described tract, an arc length of 611.03 feet, through a central angle of $7^{\circ} 04' 47''$, a radius of 4,945.00 feet, and a chord which bears South $85^{\circ} 49' 28''$ West, a long chord of 610.64 feet to an "X" cut found in the north line of said McCart-Risinger tract recorded in Instrument Number D204331963, O.P.R.T.C.T.;
- (85) **THENCE** South $82^{\circ} 34' 34''$ West, along the north line of said McCart-Risinger tract, south line of said right-of-way dedicated by said Creekside Estates, said south right-of-way line of West Risinger Road and the south line of herein described tract, a distance of 35.58 feet to an "X" cut found being a northwesterly corner of said McCart-Risinger tract and the beginning of a tangent curve to the right;
- (86) **THENCE** along said tangent curve to the right, crossing a portion of right-of-way dedicated by said Creekside Estates, along said south right-of-way line of West Risinger Road and the south line of herein described tract, an arc length of 1,287.28 feet, through a central angle of $21^{\circ} 07' 15''$, a radius of 3,492.10 feet, and a chord which bears North $86^{\circ} 34' 19''$ West, a long chord of 1,280.00 feet to the northwest corner of a tract of land described by deed to Mark Allen Hopkins, recorded in Instrument Number D204147709, O.P.R.T.C.T. at the intersection of said south right-of-way line of West Risinger Road and said east right-of-way line of McCart Avenue, from which a 5/8 inch iron rod with City of Fort Worth cap bears North $15^{\circ} 22' 50''$ East, a distance of 0.71 feet;
- (87) **THENCE** North $77^{\circ} 48' 56''$ West, crossing said right-of-way of McCart Avenue, along said south right-of-way line of West Risinger Road and the south line of herein described tract, a distance of 317.01 feet a 5/8 inch iron rod with TranSystems cap set being the northeast corner of a tract of land described by deed to The City of Fort Worth, Texas, a Municipal Corporation, recorded in Instrument Number D218246111, O.P.R.T.C.T. at the intersection of said south right-of-way line of West Risinger Road and said west right-of-way line of McCart Avenue, being the beginning of a non-tangent curve to the left;

- (88) **THENCE** along said non-tangent curve to the left, along the north line of said City of Fort Worth tract, the south line of said plat called McCart Avenue and West Risinger Road, said south right-of-way line of West Risinger Road and the south line of herein described tract, an arc length of 240.00 feet, through a central angle of $3^{\circ} 08' 53''$, a radius of 4,368.00 feet, and a chord which bears North $78^{\circ} 56' 40''$ West, a long chord of 239.97 feet to a corner from which a 1/2 inch iron rod with AEC cap found bears North $39^{\circ} 03' 36''$ East, a distance of 0.38 feet;
- (89) **THENCE** North $79^{\circ} 21' 59''$ West, continuing along the north line of said City of Fort Worth tract, the south line of said plat called of McCart Avenue and West Risinger Road, said south right-of-way line of West Risinger Road and the south line of herein described tract, a distance of 247.87 feet to a 1/2 inch iron rod with AEC cap found;
- (90) **THENCE** North $83^{\circ} 45' 43''$ West, continuing along the north line of said City of Fort Worth tract, the south line of said plat called of McCart Avenue and West Risinger Road, said south right-of-way line of West Risinger Road and the south line of herein described tract, a distance of 1,486.01 feet to a 5/8 inch iron rod with TranSystems cap set in the north line of Fox Run Addition, recorded in Cabinet A, Slide 3873, P.R.T.C.T., Instrument Number D197212679, O.P.R.T.C.T. and the south line of said plat called West Risinger Road and South Hulen Street, being the beginning of a tangent curve to the right;
- (91) **THENCE** along said tangent curve to the right, the north line of said Fox Run Addition, the south line of said plat called West Risinger Road and South Hulen Street, said south right-of-way line of West Risinger Road and the south line of herein described tract, an arc length of 249.77 feet, through a central angle of $3^{\circ} 49' 57''$, a radius of 3,734.09 feet, and a chord which bears North $81^{\circ} 50' 44''$ West, a long chord of 249.72 feet to 5/8 inch iron rod with TranSystems cap set being a northwesterly corner of Fox Run Addition, recorded in Cabinet A, Slide 4630, P.R.T.C.T., Instrument Number D198267030, O.P.R.T.C.T.;
- (92) **THENCE** North $79^{\circ} 32' 45''$ West, crossing a portion of said plat called West Risinger Road and South Hulen Street, along said south right-of-way line of West Risinger Road and the south line of herein described tract, a distance of 50.00 feet to a 5/8 inch iron rod with TranSystems cap set in a northeasterly corner of said Fox Run Addition and a southwesterly corner of said plat called West Risinger Road and South Hulen Street, being the beginning of a non-tangent curve to the right;
- (93) **THENCE** along said non-tangent curve to the right, the north line of said Fox Run Addition, the south line of said plat called West Risinger Road and South Hulen Street, said south right-of-way line of West Risinger Road and the south line of herein described tract, an arc length 407.98 feet, through a central angle of $6^{\circ} 15' 36''$, a radius of 3,734.09 feet, and a chord which bears North $76^{\circ} 01' 56''$ West, a long chord of 407.78 feet to a 5/8 inch iron rod with TranSystems cap set;
- (94) **THENCE** North $72^{\circ} 54' 08''$ West, continuing along the north line of said Fox Run Addition, the south line of said plat called West Risinger Road and South Hulen Street, said south right-of-way line of West Risinger Road and the south line of herein described tract, a distance of 788.24 feet to a 5/8 inch iron rod with TranSystems cap set, being a northwesterly corner of said Fox Run Addition and a southeasterly corner of said plat called West Risinger Road and South Hulen Street;

- (95) **THENCE** North $73^{\circ} 07' 07''$ West, crossing a portion of said plat called West Risinger Road and South Hulen Street, along said south right-of-way line of West Risinger Road and the south line of herein described tract, a distance of 64.00 feet to a 5/8 inch iron rod with TranSystems cap set, being the northeast corner of Hulen Meadows Addition, recorded in Cabinet B, Slide 2095, P.R.T.C.T., Instrument Number D200131827, O.P.R.T.C.T., a southwesterly corner of said plat called West Risinger Road and South Hulen Street and the beginning of a non-tangent curve to the left;
- (96) **THENCE** along said non-tangent curve to the left, along the north line of said Hulen Meadows Addition, the south line of said plat called West Risinger Road and South Hulen Street, said south right-of-way line of West Risinger Road and the south line of herein described tract, an arc length of 491.18 feet, through a central angle of $15^{\circ} 55' 09''$, a radius of 1,767.85 feet, and a chord which bears North $81^{\circ} 48' 33''$ West, a long chord of 489.60 feet to 5/8 inch iron rod with TranSystems cap set, from which a 5/8 inch iron rod found bears South $2^{\circ} 50' 50''$ East, a distance of 0.76 feet;
- (97) **THENCE** North $89^{\circ} 46' 08''$ West, along the north line of said Hulen Meadows Addition, the south line of said plat called West Risinger Road and South Hulen Street, said south right-of-way line of West Risinger Road and the south line of herein described tract, a distance of 978.27 feet to a 5/8 inch iron rod with illegible cap found being the northwest corner of Hulen Risinger Addition, recorded in Cabinet A, Slide 11048, P.R.T.C.T., Instrument Number D206118672, O.P.R.T.C.T. at the intersection of said south right-of-way line of West Risinger Road and said east right-of-way line of South Hulen Street;
- (98) **THENCE** South $87^{\circ} 58' 02''$ West, crossing said right-of-way of South Hulen Street, along said south right-of-way line of West Risinger Road and the south line of herein described tract, a distance of 313.00 feet to a 5/8 inch iron with illegible cap found being the northeast corner of Risinger Addition, recorded in Cabinet A, Slide 9526, P.R.T.C.T., Instrument Number D204277194, O.P.R.T.C.T. at the intersection of said south right-of-way line of West Risinger Road and said west right-of-way line of said South Hulen Street, being the beginning of a non-tangent curve to the right;
- (99) **THENCE** along said non-tangent curve to the right, along the north line of said Risinger Addition, the south line of said plat called West Risinger Road and South Hulen Street, said south right-of-way line of West Risinger Road and the south line of herein described tract, an arc length of 200.00 feet, through a central angle of $1^{\circ} 06' 34''$, a radius of 10,328.00 feet, and a chord which bears South $89^{\circ} 10' 56''$ West, a long chord of 200.00 feet to 1/2 inch iron rod found in the north line of Risinger Addition recorded in Cabinet A, Slide 11220, P.R.T.C.T., Instrument Number D206181937, O.P.R.T.C.T.;
- (100) **THENCE** North $87^{\circ} 46' 03''$ West, along the north line of said Risinger Addition, the south line of said plat called West Risinger Road and South Hulen Street, said south right-of-way line of West Risinger Road and the south line of herein described tract, a distance of 168.76 feet to a 5/8 inch iron rod with TranSystems cap set being the northwest corner of said Risinger Addition, the northeast corner of Summer Creek Ranch, recorded in Cabinet A, Slide 9480, P.R.T.C.T., Instrument Number D204251919, O.P.R.T.C.T., a southwest corner of said plat called West Risinger Road and South Hulen Street, the southeast corner of said plat called West Risinger Road Right-of-Way and the beginning of a non-tangent curve to the left;

- (101) **THENCE** along said non-tangent curve to the left, the north line of said Summer Creek Ranch, the south line of said plat called West Risinger Road Right-of-Way, said south right-of-way line of West Risinger Road and the south line of herein described tract, an arc length of 69.35 feet, through a central angle of $0^{\circ} 23' 03''$, a radius of 10,340.00 feet, and a chord which bears South $87^{\circ} 49' 04''$ West, a long chord of 69.35 feet to a 5/8 inch iron rod with Survcon cap found;
- (102) **THENCE** South $87^{\circ} 37' 31''$ West, continuing along the north line of said Summer Creek Ranch, the south line of said plat called West Risinger Road Right-of-Way, said south right-of-way line of West Risinger Road and the south line of herein described tract, a distance of 333.93 feet to the northwest corner of said Summer Creek Ranch and a southeasterly corner of said plat called West Risinger Road Right-of-Way from which a 5/8 inch iron rod found bears South $20^{\circ} 06' 08''$ East, a distance of 0.61 feet;
- (103) **THENCE** South $86^{\circ} 49' 45''$ West, crossing a portion of said plat called West Risinger Road Right-of-Way, along said south right-of-way line of West Risinger Road and the south line of herein described tract, a distance of 70.00 feet to a northeasterly corner of Summer Creek Ranch, recorded in Cabinet A, Slide 7589, P.R.T.C.T., Instrument Number D202297140, O.P.R.T.C.T. and a southwesterly corner of said plat called West Risinger Road Right-of-Way, being the beginning of a non-tangent curve to the left, from which a 5/8 inch iron rod with Survcon cap found bears South $5^{\circ} 37' 17''$ East, a distance of 0.55 feet;
- (104) **THENCE** along said non-tangent curve to the left, the north line of said Summer Creek Ranch, the south line of said plat called West Risinger Road Right-of-Way, said south right-of-way line of West Risinger Road and the south line of herein described tract, an arc length of 265.71 feet, through a central angle of $6^{\circ} 30' 22''$, a radius of 2,340.00 feet, and a chord which bears South $82^{\circ} 43' 40''$ West, a long chord of 265.57 feet to a corner from which a 5/8 inch iron rod with Survcon cap found bears South $3^{\circ} 44' 02''$ West, a distance of 0.51 feet;
- (105) **THENCE** South $79^{\circ} 28' 29''$ West, continuing along the north line of said Summer Creek Ranch, the south line of said plat called West Risinger Road Right-of-Way, said south right-of-way line of West Risinger Road and the south line of herein described tract, a distance of 910.47 feet to a 5/8 inch iron rod with Survcon cap found in the north line of Summer Creek Ranch, recorded in Cabinet A, Slide 8482, P.R.T.C.T., Instrument Number D203240178, O.P.R.T.C.T., being the beginning of a tangent curve to the right;
- (106) **THENCE** along said tangent curve to the right, along the north line of said Summer Creek Ranch, the south line of said plat called West Risinger Road Right-of-Way, said south right-of-way line of West Risinger Road and the south line of herein described tract, an arc length of 471.56 feet, through a central angle of $4^{\circ} 51' 34''$, a radius of 5,560.00 feet, and a chord which bears South $81^{\circ} 54' 16''$ West, a long chord of 471.42 feet to a 5/8 inch iron rod with TranSystems cap set being a northwesterly corner of said Summer Creek Ranch and a southeasterly corner of said plat called West Risinger Road Right-of-Way;
- (107) **THENCE** South $84^{\circ} 41' 42''$ West, crossing a portion of said plat called West Risinger Road Right-of-Way, along said south right-of-way line of West Risinger Road and the south line of herein described tract, a distance of 70.00 feet to the northeast corner of Summer Creek Ranch, recorded in Cabinet A, Slide 9122, P.R.T.C.T., Instrument Number D204107658, O.P.R.T.C.T. and a southwesterly corner of said plat called West Risinger Road Right-of-Way, being the beginning of a non-tangent curve to the right from which an "X" cut found bears North $44^{\circ} 08' 19''$ East, a distance of 0.33 feet;

- (108) **THENCE** along said non-tangent curve to the right, the north line of said Summer Creek Ranch, the south line of said plat called West Risinger Road Right-of-Way, said south right-of-way line of West Risinger Road and the south line of herein described tract, an arc length of 386.82 feet, through a central angle of $3^{\circ} 59' 10''$, a radius of 5,560.00 feet, and a chord which bears South $87^{\circ} 02' 55''$ West, a long chord of 386.74 feet to a corner from which a 5/8 inch iron rod with Survcon cap found bears North $33^{\circ} 44' 20''$ East, a distance of 0.40 feet;
- (109) **THENCE** South $89^{\circ} 02' 30''$ West, continuing along the north line of said Summer Creek Ranch, the south line of said plat called West Risinger Road Right-of-Way, said south right-of-way line of West Risinger Road and the south line of herein described tract, a distance of 882.83 feet to an "X" cut set in the north line of said Final Plat of Summer Creek South, recorded in Cabinet A, Slide 11030, P.R.T.C.T., Instrument Number D206108553, O.P.R.T.C.T. and the south line of right-of-way dedicated by said Summer Creek South;
- (110) **THENCE** North $89^{\circ} 22' 05''$ West, along the north line of said Summer Creek South, the south line of right-of-way dedicated by said Summer Creek South, said south right-of-way line of West Risinger Road and the south line of herein described tract, a distance of 278.45 feet to a 5/8 inch iron rod with RPLS 4224 cap being the beginning of a tangent curve to the left;
- (111) **THENCE** along said tangent curve to the left, continuing along the north line of said Summer Creek South, the south line of right-of-way dedicated by said Summer Creek South, said south right-of-way line of West Risinger Road and the south line of herein described tract, an arc length of 550.01 feet, through a central angle of $27^{\circ} 17' 03''$, a radius of 1,155.00 feet, and a chord which bears South $76^{\circ} 59' 23''$ West, a long chord of 544.83 feet to 5/8 inch iron rod with RPLS 4224 cap found being the beginning of a tangent curve to the right;
- (112) **THENCE** along said tangent curve to the right, continuing along the north line of said Summer Creek South, the south line of right-of-way dedicated by said Summer Creek South, said south right-of-way line of West Risinger Road and the south line of herein described tract, at an arc length of 4.76 feet passing a 5/8 inch iron rod with RPLS 4224 cap found, in all an arc length of 612.55 feet, through a central angle of $14^{\circ} 52' 17''$, a radius of 2,360.00 feet, and a chord which bears South $70^{\circ} 47' 02''$ West, a long chord of 610.83 feet to an "X" cut found being a northwesterly corner of Final Plat of Summer Creek South Phase Four, recorded in Instrument Number D216223520, O.P.R.T.C.T. and the northeast corner of Final Plat of Summer Creek Drive and McPherson Boulevard Right-of-Way, recorded in Instrument Number D213105897, O.P.R.T.C.T. at the intersection of said south right-of-way line of West Risinger Road and said east right-of-way line of Summer Creek Drive;
- (113) **THENCE** South $78^{\circ} 31' 06''$ West, crossing a portion of said Final Plat of Summer Creek Drive and McPherson Boulevard Right-of-Way and said right-of-way of Summer Creek Drive, along said south right-of-way line of West Risinger Road and the south line of herein described tract, a distance of 256.11 feet, to a 5/8 inch iron rod with TranSystems cap set being a northeasterly corner of a tract of land described by deed to Total E&P USA Barnett, LLC, recorded in Instrument Number D216266568, O.P.R.T.C.T. in the south line of said City of Fort Worth right-of-way easement recorded in Instrument Number D206245569, O.P.R.T.C.T. at the intersection of said south right-of-way line of West Risinger Road and the west right-of-way line of Summer Creek Drive;

- (114) **THENCE** South 80° 25' 44" West, along the north line of said Total E&P tract, the south line of said City of Fort Worth right-of-way easement, said south right-of-way line of West Risinger Road and the south line of herein described tract, a distance of 43.51 feet, to a 1/2 inch iron rod with Weir & Associates cap found being the beginning of a tangent curve to the right;
- (115) **THENCE** along said tangent curve to the right, continuing along the north line of said Total E&P tract, the south line of said City of Fort Worth right-of-way easement, said south right-of-way line of West Risinger Road and the south line of herein described tract, an arc length of 139.05 feet, through a central angle of 3° 40' 36", a radius of 2,167.00 feet, and a chord which bears South 82° 16' 02" West, a long chord of 139.03 feet to a 1/2 inch iron rod with Weir & Associated cap found being the beginning of a tangent curve to the right;
- (116) **THENCE** along said tangent curve to the right, continuing along the north line of said Total E&P tract, the south line of said City of Fort Worth right-of-way easement, said south right-of-way line of West Risinger Road and the south line of herein described tract, an arc length of 4.92 feet, through a central angle of 0° 27' 45", a radius of 609.50 feet, and a chord which bears South 84° 20' 11" West, a long chord of 4.92 feet to a 5/8 inch iron rod with TranSystems & Associates cap set being the southwest corner of herein described tract;
- (117) **THENCE** North 5° 25' 56" West, crossing said City of Fort Worth right-of-way easement and said right-of-way line of West Risinger Road, along the west line of herein described tract, a distance of 122.11 feet to the **POINT OF BEGINNING**, containing 53.719 acres (2,339,998 square feet) of land, more or less.

NOTE: Basis of bearing is the Texas Coordinate System of 1983, North Central Zone (4202), North American Datum 1983 (NAD 83)(2007) with all distances adjusted to surface by project combined scale factor of 0.9998802448.

NOTE: Plat to accompany this legal description

I, Daniel M. Putman, a Registered Professional Land Surveyor in the State of Texas, hereby state that this survey was made from an actual on the ground survey performed in August, 2020 under my supervision, that all monuments exist as shown hereon and this survey substantially conforms with the current professional and technical standards set forth by the Texas Board of Professional Engineers and Land Surveyors.



Daniel M. Putman
Registered Professional Land Surveyor
Texas Registration Number 6729
Texas Surveying Firm 10038300
TranSystems Corporation
500 West 7th Street, Suite 1100
Fort Worth, TX 76102



SHEET LAYOUT

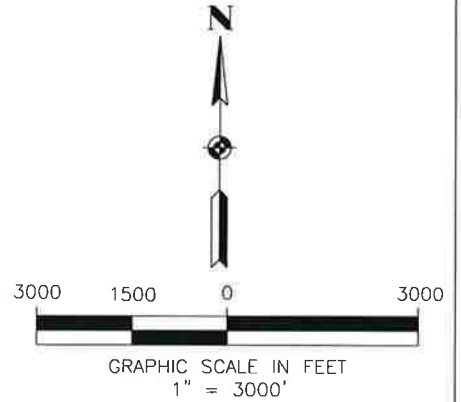
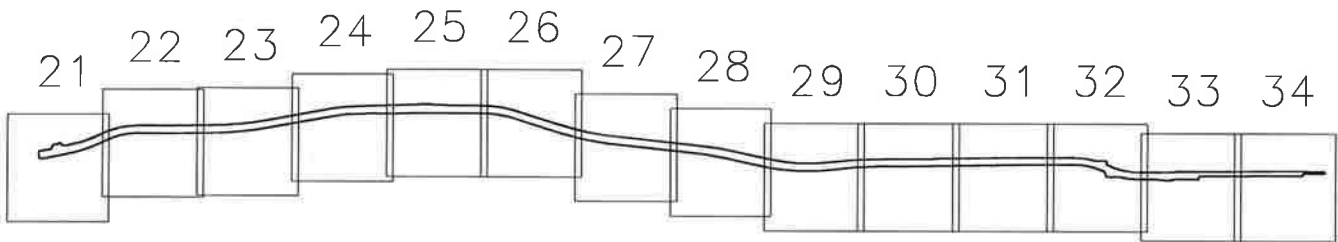

500 WEST SEVENTH STREET
SUITE 1100
FORT WORTH, TX 76102
(817) 339-8950 (TEL)
(817) 549-7524 (FAX)
TX SURV FIRM NO. 10038300

PROJ NO: P202090330
SCALE: 1" = 3000'
DATE: 12-14-2020
DRAWN BY: DMP
CHECKED BY: KDE
REVISED DATE: 5-14-2021

PRINTED ON:

5/14/2021
11:30 AM

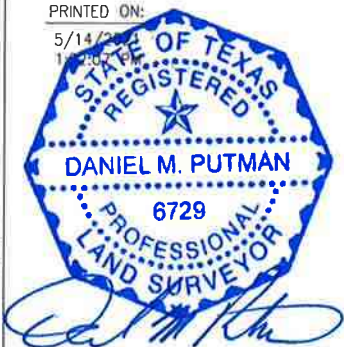

SHEET TITLE

EXHIBIT "A"
SEGMENT 9, PARCEL 1021
WEST RISINGER ROAD

PROJECT

INTEGRATED PIPELINE PROJECT

BASIS OF BEARING IS THE TEXAS COORDINATE SYSTEM OF 1983,
NORTH CENTRAL ZONE (4202), NORTH AMERICAN DATUM 1983
(NAD83)(2007) WITH ALL DISTANCES ADJUSTED TO SURFACE BY
PROJECT COMBINED SCALE FACTOR 0.9998802448

EXHIBIT "A"
PARCEL 1021

J.J. ALBIRADO SURVEY
ABSTRACT 4

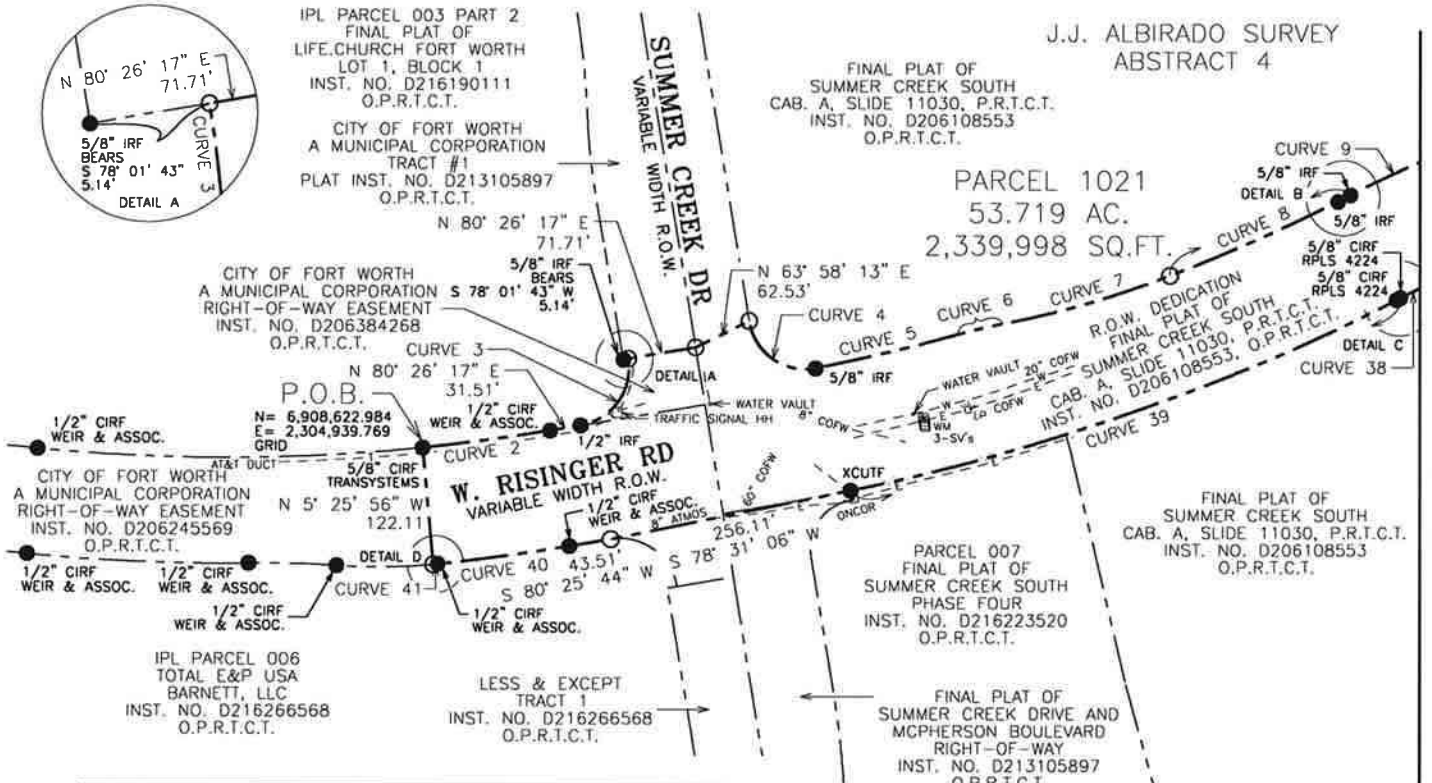

CURVE	DELTA	RADIUS	LENGTH	CHORD BEARING	LONG CHORD
2	3' 47' 14" (LT)	2,045.00	135.17	N 82° 19' 53" E	135.15
3	90° 00' 00" (LT)	60.29	94.70	N 35° 26' 17" E	85.26
4	91° 58' 53" (LT)	60.00	96.32	S 55° 33' 48" E	86.31
5	3° 51' 27" (LT)	2,228.00	150.00	N 76° 31' 02" E	149.97
6	4° 38' 51" (RT)	610.00	49.48	N 76° 54' 44" E	49.47
7	10° 35' 59" (LT)	990.00	183.15	N 73° 56' 10" E	182.89
8	5° 17' 17" (LT)	2,240.00	206.74	N 65° 59' 32" E	206.67
9	27° 17' 03" (RT)	1,275.00	607.15	N 76° 59' 24" E	601.43
38	27° 17' 03" (LT)	1,155.00	550.01	S 76° 59' 23" W	544.83
39	14° 52' 17" (RT)	2,360.00	612.55	S 70° 47' 02" W	610.83
40	3° 40' 36" (RT)	2,167.00	139.05	S 82° 16' 02" W	139.03
41	0° 27' 45" (RT)	609.50	4.92	S 84° 20' 11" W	4.92

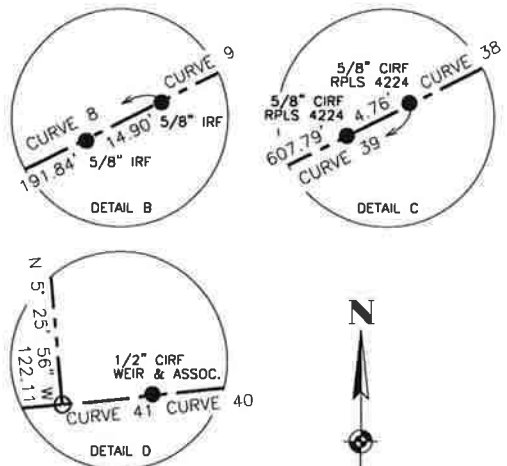

- NOTES:
 1. KNOWN UNDERGROUND UTILITIES SHOWN ARE QUALITY LEVEL B AND D SUE (09-20-2016).
 2. LEGAL DESCRIPTION TO ACCOMPANY THIS PLAT.

LEGEND

- = MARKER FOUND AS NOTED
- = 5/8" CIRS STAMPED TRANSYSTEMS

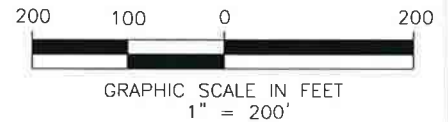

SEE SHEET 22

TranSystems

500 WEST SEVENTH STREET
 SUITE 1100
 FORT WORTH, TX 76102
 (817) 339-8950 (TEL)
 (817) 549-7524 (FAX)
 TX SURV FIRM NO. 10038300

PROJ NO:	P202090330
SCALE:	1" = 200'
DATE:	12-14-2020
DRAWN BY:	DMP
CHECKED BY:	KDE
REVISED DATE:	5-14-2021

PRINTED ON:
5/14/2021
1:52:27 PM

DANIEL M. PUTMAN
6729
PROFESSIONAL
LAND SURVEYOR

SHEET TITLE
 EXHIBIT "A"
 SEGMENT 9, PARCEL 1021
 WEST RISINGER ROAD

PROJECT
 INTEGRATED PIPELINE PROJECT

BASIS OF BEARING IS THE TEXAS COORDINATE SYSTEM OF 1983, NORTH CENTRAL ZONE (4202), NORTH AMERICAN DATUM 1983 (NAD83)(2007) WITH ALL DISTANCES ADJUSTED TO SURFACE BY PROJECT COMBINED SCALE FACTOR 0.9998802448

EXHIBIT "A"
PARCEL 1021

R.J. WARE SURVEY
ABSTRACT 2008

A. CASTELLO SURVEY
ABSTRACT 272

FINAL PLAT OF
SUMMER CREEK SOUTH
CAB. A, SLIDE 8806, P.R.T.C.T.
INST. NO. D203434631
O.P.R.T.C.T.

SUMMER CREEK RANCH
CAB. A, SLIDE 6341, P.R.T.C.T.
INST. NO. D200287466
O.P.R.T.C.T.

SUMMER CREEK SOUTH
CAB. A, SLIDE 11030, P.R.T.C.T.
INST. NO. D206108553
O.P.R.T.C.T.

R.O.W. DEDICATION
FINAL PLAT OF
SUMMER CREEK SOUTH
CAB. A, SLIDE 8806, P.R.T.C.T.
INST. NO. D203434631
O.P.R.T.C.T.

PARCEL 1021
53.719 AC.
2,339,998 SQ.FT.

S 89° 22' 05" E 276.79'

N 89° 02' 30" E 881.15'

1/2" CIRF
I LLEGIBLE

WEST RISINGER ROAD RIGHT-OF-WAY
CAB. A, SLIDE 6286, P.R.T.C.T.
INST. NO. D200265139
O.P.R.T.C.T.

W. RISINGER RD
VARIABLE WIDTH R.O.W.

N 89° 22' 05" W 278.45'

S 89° 02' 30" W 882.83'

R.O.W. DEDICATION
FINAL PLAT OF
SUMMER CREEK SOUTH
CAB. A, SLIDE 11030, P.R.T.C.T.
INST. NO. D206108553
O.P.R.T.C.T.

FINAL PLAT OF
SUMMER CREEK SOUTH
CAB. A, SLIDE 11030, P.R.T.C.T.
INST. NO. D206108553
O.P.R.T.C.T.

SUMMER CREEK RANCH
CAB. A, SLIDE 9122, P.R.T.C.T.
INST. NO. D204107658
O.P.R.T.C.T.

CURVE	DELTA	RADIUS	LENGTH	CHORD BEARING	LONG CHORD
9	27° 17' 03" (RT)	1,275.00	607.15	N 76° 59' 24" E	601.43
38	27° 17' 03" (LT)	1,155.00	550.01	S 76° 59' 23" W	544.83

J.J. ALBRADO
SURVEY
ABSTRACT 4

NOTE: LEGAL DESCRIPTION TO ACCOMPANY THIS PLAT.

LEGEND

- = MARKER FOUND AS NOTED
- = 5/8" CIRFS STAMPED TRANSYSTEMS
- = X-CUT SET

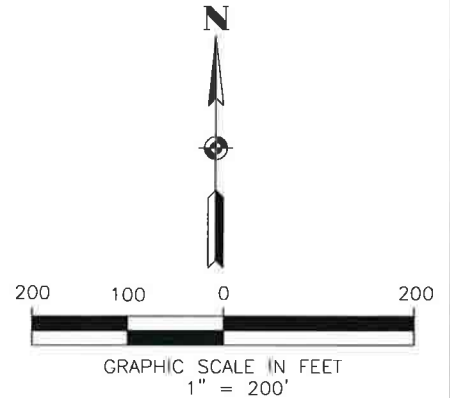

500 WEST SEVENTH STREET
SUITE 1100
FORT WORTH, TX 76102
(817) 339-8950 (TEL)
(817) 549-7524 (FAX)
TX SURV FIRM NO. 10038300

PROJ NO: P202090330
SCALE: 1" = 200'
DATE: 12-14-2020
DRAWN BY: DMP
CHECKED BY: KDE
REVISED DATE: 5-14-2021

PRINTED ON:



SHEET TITLE

EXHIBIT "A"
SEGMENT 9, PARCEL 1021
WEST RISINGER ROAD

PROJECT

INTEGRATED PIPELINE PROJECT

BASIS OF BEARING IS THE TEXAS COORDINATE SYSTEM OF 1983,
NORTH CENTRAL ZONE (4202), NORTH AMERICAN DATUM 1983
(NAD83)(2007) WITH ALL DISTANCES ADJUSTED TO SURFACE BY
PROJECT COMBINED SCALE FACTOR 0.9998802448

EXHIBIT "A"
PARCEL 1021

SUMMER CREEK RANCH
CAB. A, SLIDE 6341, P.R.T.C.T.
INST. NO. D200287466
O.P.R.T.C.T.

A. CASTELLO SURVEY
ABSTRACT 272

SUMMER CREEK RANCH
CAB. A, SLIDE 6284, P.R.T.C.T.
INST. NO. D200265137
O.P.R.T.C.T.

PARCEL 1021
53.719 AC.
2,339,998 SQ.FT.

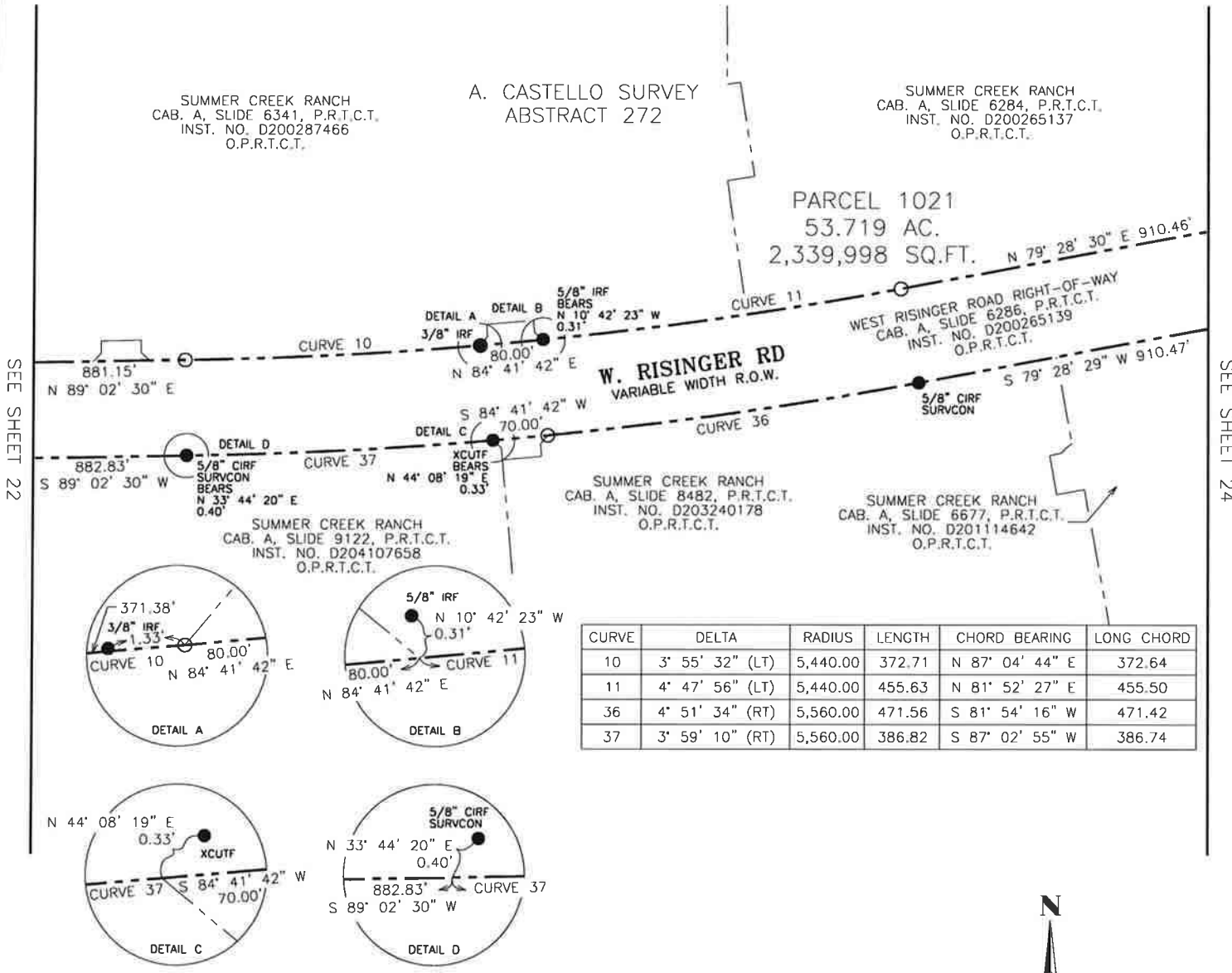

SEE SHEET 22

SEE SHEET 24

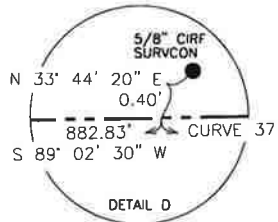
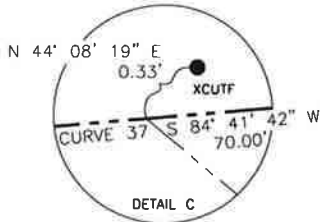
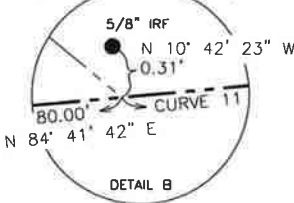
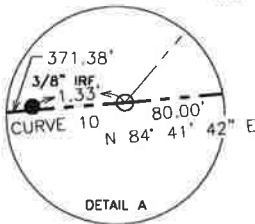

CURVE	DELTA	RADIUS	LENGTH	CHORD BEARING	LONG CHORD
10	3° 55' 32" (LT)	5,440.00	372.71	N 87° 04' 44" E	372.64
11	4° 47' 56" (LT)	5,440.00	455.63	N 81° 52' 27" E	455.50
36	4° 51' 34" (RT)	5,560.00	471.56	S 81° 54' 16" W	471.42
37	3° 59' 10" (RT)	5,560.00	386.82	S 87° 02' 55" W	386.74

NOTE: LEGAL DESCRIPTION TO ACCOMPANY THIS PLAT.

LEGEND

- = MARKER FOUND AS NOTED
- = 5/8" CIRTS STAMPED TRANSYSTEMS

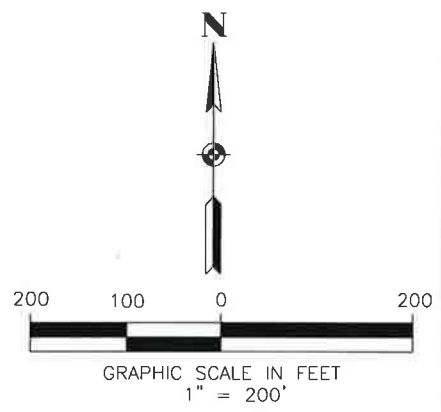

TranSystems

500 WEST SEVENTH STREET
SUITE 1100
FORT WORTH, TX 76102
(817) 339-8950 (TEL)
(817) 549-7524 (FAX)
TX SURV FIRM NO. 10038300

PROJ NO:	P202090330
SCALE:	1" = 200'
DATE:	12-14-2020
DRAWN BY:	DMP
CHECKED BY:	KDE
REVISED DATE:	5-14-2021

PRINTED ON:
5/14/2021
12:21:00 PM

DANIEL M. PUTMAN
6729
PROFESSIONAL
LAND SURVEYOR

SHEET TITLE

EXHIBIT "A"
SEGMENT 9, PARCEL 1021
WEST RISINGER ROAD

PROJECT

INTEGRATED PIPELINE PROJECT

BASIS OF BEARING IS THE TEXAS COORDINATE SYSTEM OF 1983, NORTH CENTRAL ZONE (4202), NORTH AMERICAN DATUM 1983 (NAD83)(2007) WITH ALL DISTANCES ADJUSTED TO SURFACE BY PROJECT COMBINED SCALE FACTOR 0.9998802448

EXHIBIT "A"
PARCEL 1021

A. CASTELLO SURVEY
ABSTRACT 272

PARCEL 1021
53.719 AC.
2,339,998 SQ.FT.

SUMMER CREEK RANCH
CAB. A, SLIDE 6284, P.R.T.C.T.
INST. NO. D200265137
O.P.R.T.C.T.

STONE MEADOW
COMMERCIAL ADDITION
CAB. A, SLIDE 8215, P.R.T.C.T.
INST. NO. D203092399
O.P.R.T.C.T.

WEST RISINGER ROAD AND
SOUTH HULEN STREET
VOL. 388-204, PG. 89, P.R.T.C.T.
INST. NO. D186045378
O.P.R.T.C.T.

WEST RISINGER ROAD RIGHT-OF-WAY
CAB. A, SLIDE 6286, P.R.T.C.T.
INST. NO. D200265139
O.P.R.T.C.T.

SUMMER CREEK RANCH
CAB. A, SLIDE 6677, P.R.T.C.T.
INST. NO. D20114642
O.P.R.T.C.T.

SUMMER CREEK RANCH
CAB. A, SLIDE 7589, P.R.T.C.T.
INST. NO. D202297140
O.P.R.T.C.T.

SUMMER CREEK RANCH
CAB. A, SLIDE 9480, P.R.T.C.T.
INST. NO. D204251919
O.P.R.T.C.T.

RISINGER ADDITION
CAB. A, SLIDE 11220, P.R.T.C.T.
INST. NO. D206181937
O.P.R.T.C.T.

RISINGER ADDITION
CAB. A, SLIDE 9526, P.R.T.C.T.
INST. NO. D204277194
O.P.R.T.C.T.

SEE SHEET 23

SEE SHEET 25

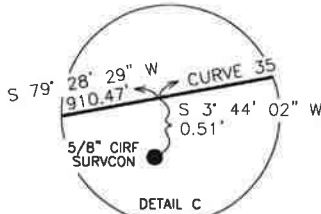
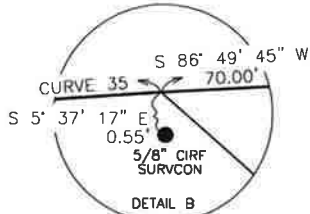
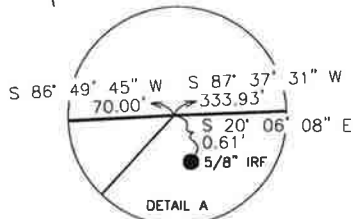

CURVE	DELTA	RADIUS	LENGTH	CHORD BEARING	LONG CHORD
12	6° 32' 52" (RT)	2,460.00	281.13	N 82° 44' 55" E	280.98
13	2° 21' 22" (RT)	10,460.00	430.15	N 88° 30' 48" E	430.12
33	1° 06' 34" (RT)	10,328.00	200.00	S 89° 10' 56" W	200.00
34	0° 23' 03" (LT)	10,340.00	69.35	S 87° 49' 04" W	69.35
35	6° 30' 22" (LT)	2,340.00	265.71	S 82° 43' 40" W	265.57

NOTE: LEGAL DESCRIPTION TO ACCOMPANY THIS PLAT.

LEGEND

- = MARKER FOUND AS NOTED
- = 5/8" CIRS STAMPED TRANSYSTEMS

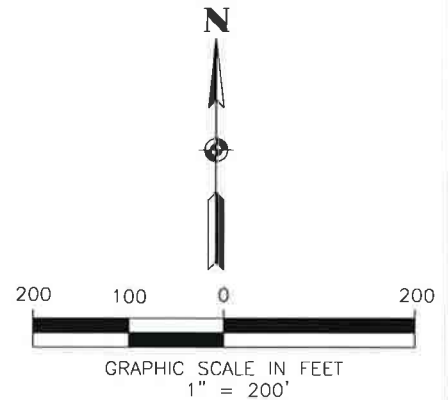

500 WEST SEVENTH STREET
SUITE 1100
FORT WORTH, TX 76102
(817) 339-8950 (TEL)
(817) 549-7524 (FAX)
TX SURV FIRM NO. 10038300

PROJ NO: P202090330
SCALE: 1" = 200'
DATE: 12-14-2020
DRAWN BY: DMP
CHECKED BY: KDE
REVISED DATE: 5-14-2021

PRINTED ON:

5/14/2021

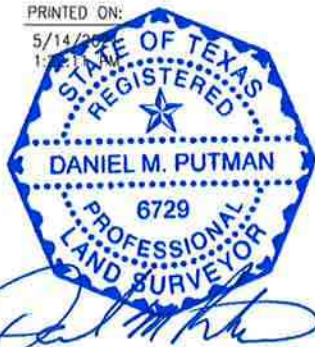

SHEET TITLE

EXHIBIT "A"
SEGMENT 9, PARCEL 1021
WEST RISINGER ROAD

PROJECT

INTEGRATED PIPELINE PROJECT

BASIS OF BEARING IS THE TEXAS COORDINATE SYSTEM OF 1983,
NORTH CENTRAL ZONE (4202), NORTH AMERICAN DATUM 1983
(NAD83)(2007) WITH ALL DISTANCES ADJUSTED TO SURFACE BY
PROJECT COMBINED SCALE FACTOR 0.9998802448

EXHIBIT "A"
PARCEL 1021

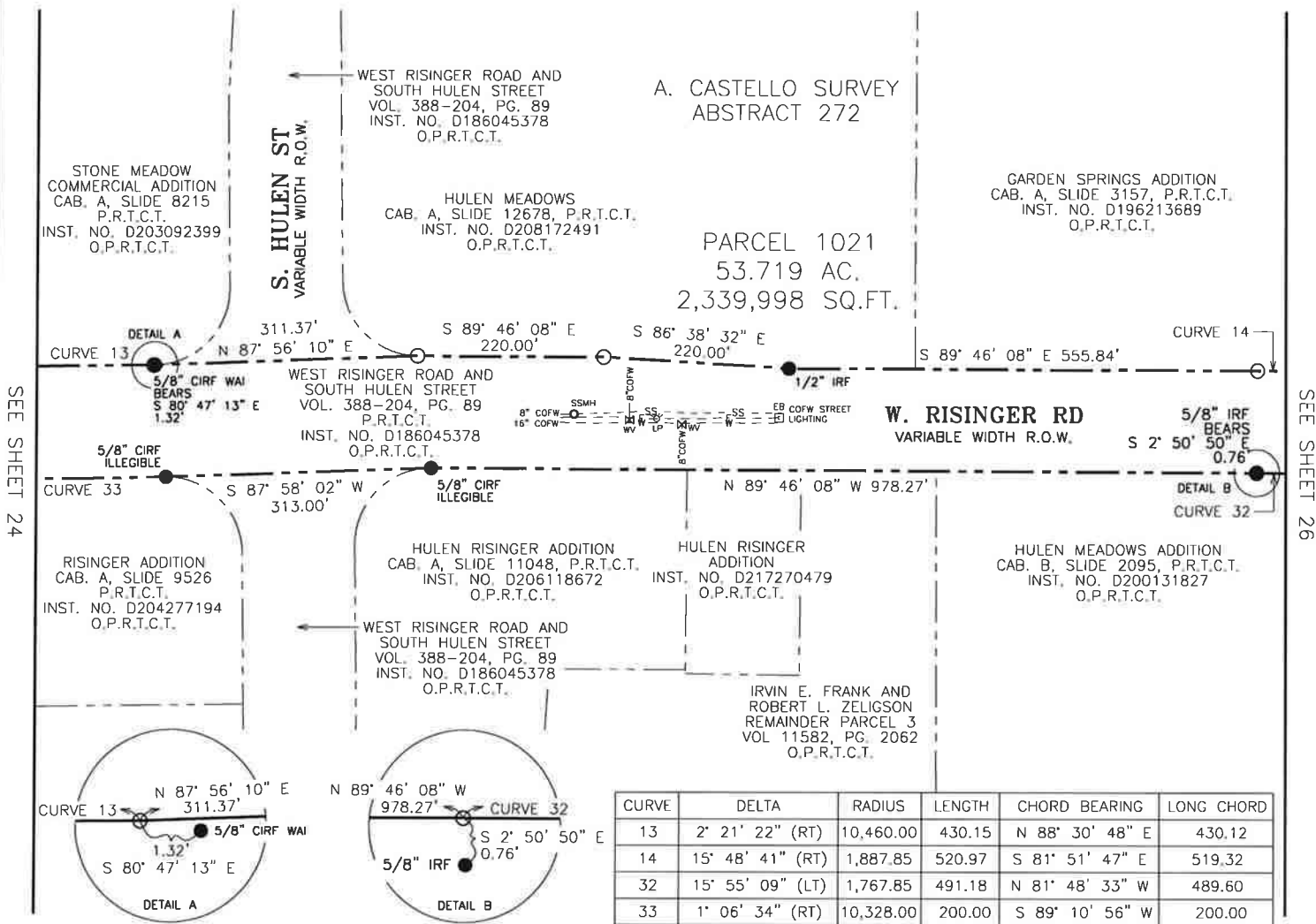

CURVE	DELTA	RADIUS	LENGTH	CHORD BEARING	LONG CHORD
13	2° 21' 22" (RT)	10,460.00	430.15	N 88° 30' 48" E	430.12
14	15° 48' 41" (RT)	1,887.85	520.97	S 81° 51' 47" E	519.32
32	15° 55' 09" (LT)	1,767.85	491.18	N 81° 48' 33" W	489.60
33	1° 06' 34" (RT)	10,328.00	200.00	S 89° 10' 56" W	200.00

NOTES:

1. KNOWN UNDERGROUND UTILITIES SHOWN ARE QUALITY LEVEL B SUE (09-20-2016).
2. LEGAL DESCRIPTION TO ACCOMPANY THIS PLAT.

LEGEND

- = MARKER FOUND AS NOTED
- = 5/8" CIRTS STAMPED TRANSYSTEMS

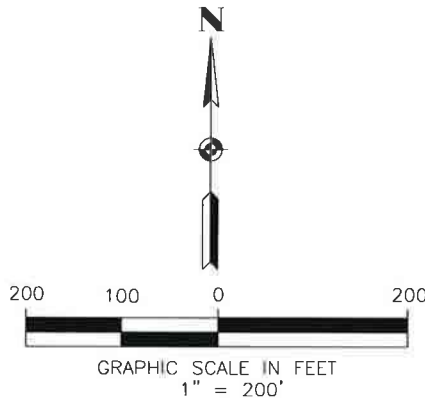

TranSystems

500 WEST SEVENTH STREET
SUITE 1100
FORT WORTH, TX 76102
(817) 339-8950 (TEL.)
(817) 549-7524 (FAX)
TX SURV FIRM NO. 10038300

PROJ NO:	P202090330
SCALE:	1" = 200'
DATE:	12-14-2020
DRAWN BY:	DMP
CHECKED BY:	KDE
REVISED DATE:	5-14-2021

PRINTED ON:
5/14/2021
1:27:12 PM

STATE OF TEXAS
REGISTERED
DANIEL M. PUTMAN
6729
PROFESSIONAL
LAND SURVEYOR

SHEET TITLE
EXHIBIT "A"
SEGMENT 9, PARCEL 1021
WEST RISINGER ROAD

PROJECT
INTEGRATED PIPELINE PROJECT

BASIS OF BEARING IS THE TEXAS COORDINATE SYSTEM OF 1983, NORTH CENTRAL ZONE (4202), NORTH AMERICAN DATUM 1983 (NAD83)(2007) WITH ALL DISTANCES ADJUSTED TO SURFACE BY PROJECT COMBINED SCALE FACTOR 0.9998802448

EXHIBIT "A"
PARCEL 1021

A. CASTELLO SURVEY
ABSTRACT 272

GARDEN SPRINGS ADDITION
CAB. A, SLIDE 3157, P.R.T.C.T.
INST. NO. D196213689
O.P.R.T.C.T.

GARDEN SPRING ADDITION
CAB. A, SLIDE 2620, P.R.T.C.T.
INST. NO. D195230316
O.P.R.T.C.T.

PARCEL 1021
53.719 AC.
2,339,998 SQ.FT.

HULEN MEADOWS ADDITION
CAB. B, SLIDE 2095, P.R.T.C.T.
INST. NO. D200131827
O.P.R.T.C.T.

WEST RISINGER ROAD AND
SOUTH HULEN STREET
VOL. 388-204, PG. 89, P.R.T.C.T.
INST. NO. D186045378
O.P.R.T.C.T.

W. RISINGER RD
VARIABLE WIDTH R.O.W.

FOX RUN ADDITION
CAB. A, SLIDE 4630, P.R.T.C.T.
INST. NO. D198267030
O.P.R.T.C.T.

SEE SHEET 25

SEE SHEET 27

CURVE	DELTA	RADIUS	LENGTH	CHORD BEARING	LONG CHORD
14	15' 48' 41" (RT)	1,887.85	520.97	S 81' 51' 47" E	519.32
15	10' 51' 35" (LT)	3,614.09	685.01	S 78' 19' 55" E	683.98
31	6' 15' 36" (RT)	3,734.09	407.98	N 76' 01' 56" W	407.78
32	15' 55' 09" (LT)	1,767.85	491.18	N 81' 48' 33" W	489.60

NOTE: LEGAL DESCRIPTION TO ACCOMPANY THIS PLAT.

LEGEND

- = MARKER FOUND AS NOTED
- = 5/8" CIRS STAMPED TRANSYSTEMS

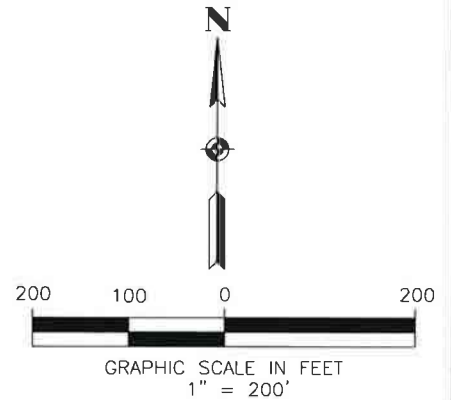

TranSystems

500 WEST SEVENTH STREET
SUITE 1100
FORT WORTH, TX 76102
(817) 339-8950 (TEL)
(817) 549-7524 (FAX)
TX SURV FIRM NO. 10038300

PROJ NO:	P202090330
SCALE:	1" = 200'
DATE:	12-14-2020
DRAWN BY:	DMP
CHECKED BY:	KDE
REVISED DATE:	5-14-2021

PRINTED ON:
5/14/2021
10:21 AM

Daniel M. Putman

SHEET TITLE

EXHIBIT "A"
SEGMENT 9, PARCEL 1021
WEST RISINGER ROAD

PROJECT

INTEGRATED PIPELINE PROJECT

BASIS OF BEARING IS THE TEXAS COORDINATE SYSTEM OF 1983, NORTH CENTRAL ZONE (4202), NORTH AMERICAN DATUM 1983 (NAD83)(2007) WITH ALL DISTANCES ADJUSTED TO SURFACE BY PROJECT COMBINED SCALE FACTOR 0.9998802448

EXHIBIT "A"
PARCEL 1021

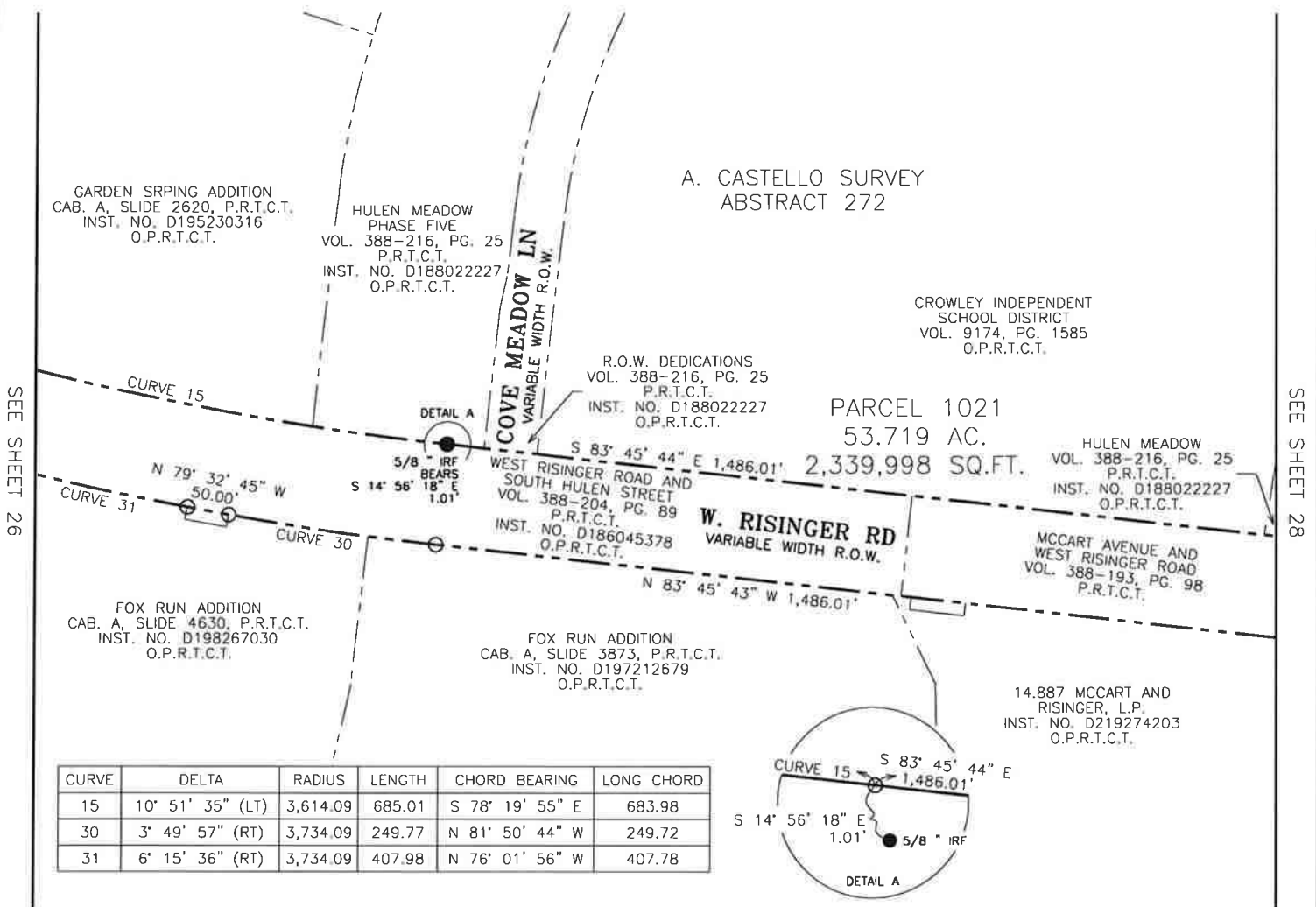

SEE SHEET 26

SEE SHEET 28

CURVE	DELTA	RADIUS	LENGTH	CHORD BEARING	LONG CHORD
15	10° 51' 35" (LT)	3,614.09	685.01	S 78° 19' 55" E	683.98
30	3° 49' 57" (RT)	3,734.09	249.77	N 81° 50' 44" W	249.72
31	6° 15' 36" (RT)	3,734.09	407.98	N 76° 01' 56" W	407.78

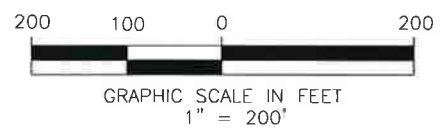
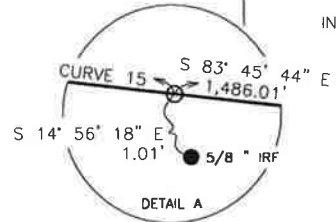

NOTE: LEGAL DESCRIPTION TO ACCOMPANY THIS PLAT.

LEGEND

- = MARKER FOUND AS NOTED
- = 5/8" CIRS STAMPED TRANSYSTEMS

TranSystems

500 WEST SEVENTH STREET
SUITE 1100
FORT WORTH, TX 76102
(817) 339-8950 (TEL)
(817) 549-7524 (FAX)
TX SURV FIRM NO. 10038300

PROJ NO: P202090330
SCALE: 1" = 200'
DATE: 12-14-2020
DRAWN BY: DMP
CHECKED BY: KDE
REVISED DATE: 5-14-2021

PRINTED ON:
5/14/2021
12:21:25 PM

STATE OF TEXAS
REGISTERED
DANIEL M. PUTMAN
6729
PROFESSIONAL
LAND SURVEYOR

SHEET TITLE
EXHIBIT "A"
SEGMENT 9, PARCEL 1021
WEST RISINGER ROAD

PROJECT
INTEGRATED PIPELINE PROJECT

BASIS OF BEARING IS THE TEXAS COORDINATE SYSTEM OF 1983,
NORTH CENTRAL ZONE (4202), NORTH AMERICAN DATUM 1983
(NAD83)(2007) WITH ALL DISTANCES ADJUSTED TO SURFACE BY
PROJECT COMBINED SCALE FACTOR 0.9998802448

EXHIBIT "A"
PARCEL 1021

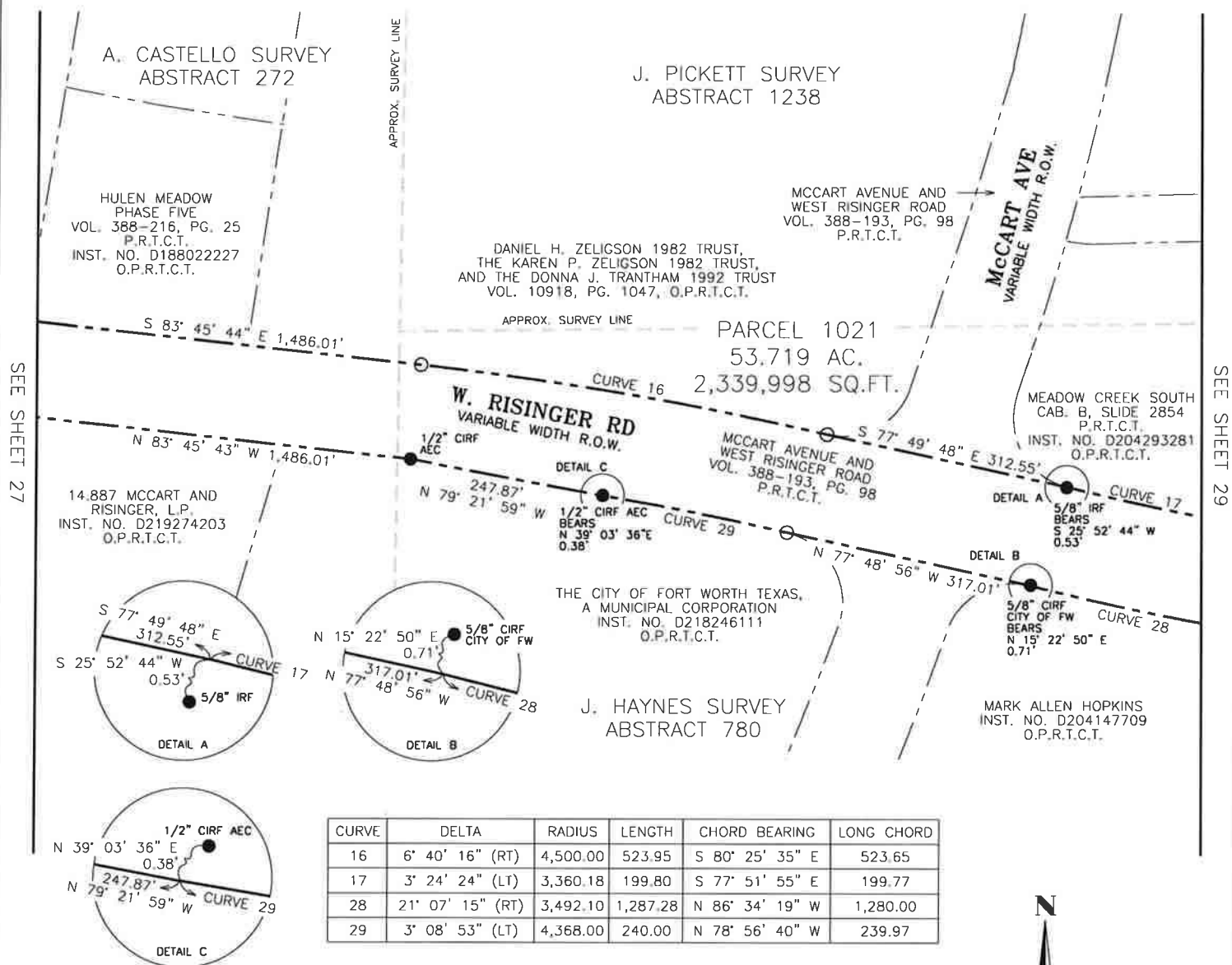

CURVE	DELTA	RADIUS	LENGTH	CHORD BEARING	LONG CHORD
16	6° 40' 16" (RT)	4,500.00	523.95	S 80° 25' 35" E	523.65
17	3° 24' 24" (LT)	3,360.18	199.80	S 77° 51' 55" E	199.77
28	21° 07' 15" (RT)	3,492.10	1,287.28	N 86° 34' 19" W	1,280.00
29	3° 08' 53" (LT)	4,368.00	240.00	N 78° 56' 40" W	239.97

NOTE: LEGAL DESCRIPTION TO ACCOMPANY THIS PLAT.

LEGEND

- = MARKER FOUND AS NOTED
- = 5/8" CIRS STAMPED TRANSYSTEMS

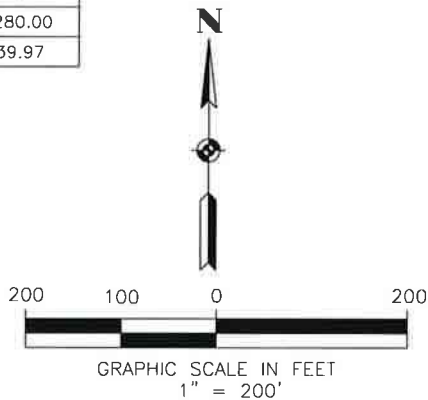

TranSystems

500 WEST SEVENTH STREET
SUITE 1100
FORT WORTH, TX 76102
(817) 339-8950 (TEL)
(817) 549-7524 (FAX)
TX SURV FIRM NO. 10038300

PROJ NO:	P202090330
SCALE:	1" = 200'
DATE:	12-14-2020
DRAWN BY:	DMP
CHECKED BY:	KDE
REVISED DATE:	5-14-2021

PRINTED ON:
5/14/2021

DANIEL M. PUTMAN
6729
PROFESSIONAL
LAND SURVEYOR

SHEET TITLE
**EXHIBIT "A"
SEGMENT 9, PARCEL 1021
WEST RISINGER ROAD**

PROJECT
INTEGRATED PIPELINE PROJECT

BASIS OF BEARING IS THE TEXAS COORDINATE SYSTEM OF 1983, NORTH CENTRAL ZONE (4202), NORTH AMERICAN DATUM 1983 (NAD83)(2007) WITH ALL DISTANCES ADJUSTED TO SURFACE BY PROJECT COMBINED SCALE FACTOR 0.9998802448

EXHIBIT "A"
PARCEL 1021

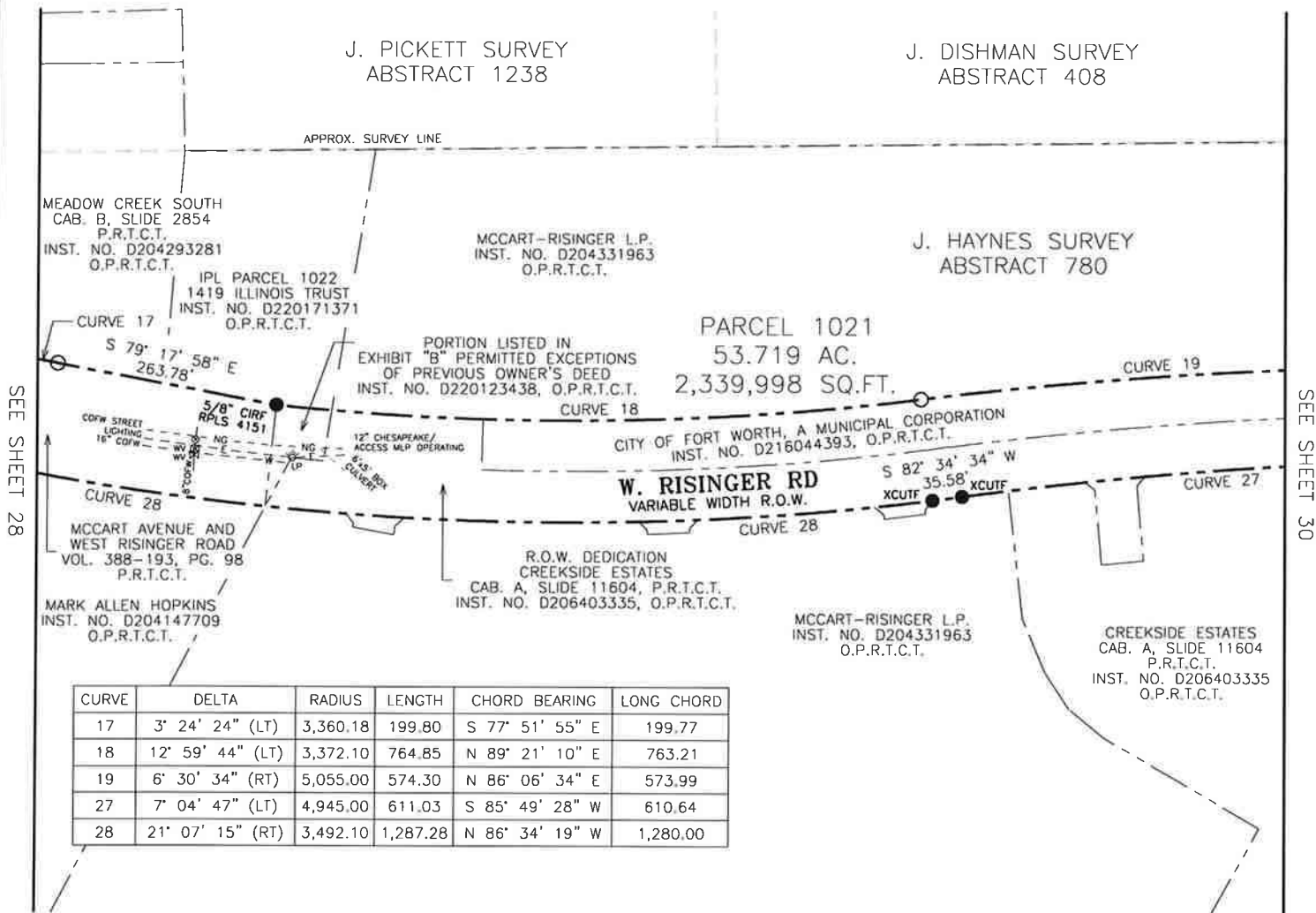

CURVE	DELTA	RADIUS	LENGTH	CHORD BEARING	LONG CHORD
17	3' 24' 24" (LT)	3,360.18	199.80	S 77° 51' 55" E	199.77
18	12' 59' 44" (LT)	3,372.10	764.85	N 89° 21' 10" E	763.21
19	6' 30' 34" (RT)	5,055.00	574.30	N 86° 06' 34" E	573.99
27	7' 04' 47" (LT)	4,945.00	611.03	S 85° 49' 28" W	610.64
28	21' 07' 15" (RT)	3,492.10	1,287.28	N 86° 34' 19" W	1,280.00

- NOTES:
 1. KNOWN UNDERGROUND UTILITIES SHOWN ARE QUALITY LEVEL B AND D SUE (09-20-2016).
 2. LEGAL DESCRIPTION TO ACCOMPANY THIS PLAT.

LEGEND

- = MARKER FOUND AS NOTED
- = 5/8" CIRS STAMPED TRANSYSTEMS

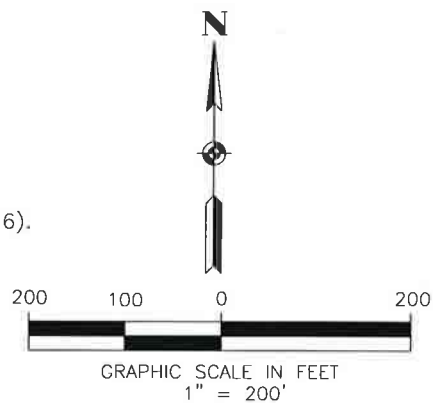

TranSystems

500 WEST SEVENTH STREET
SUITE 1100
FORT WORTH, TX 76102
(817) 339-8950 (TEL)
(817) 549-7524 (FAX)
TX SURV FIRM NO. 10038300

PROJ NO:	P202090330
SCALE:	1" = 200'
DATE:	12-14-2020
DRAWN BY:	DMP
CHECKED BY:	KDE
REVISED DATE:	5-14-2021

PRINTED ON:
5/14/2021 12:21 PM

Daniel M. Putman

SHEET TITLE
EXHIBIT "A"
SEGMENT 9, PARCEL 1021
WEST RISINGER ROAD

PROJECT
INTEGRATED PIPELINE PROJECT

BASIS OF BEARING IS THE TEXAS COORDINATE SYSTEM OF 1983, NORTH CENTRAL ZONE (4202), NORTH AMERICAN DATUM 1983 (NAD83)(2007) WITH ALL DISTANCES ADJUSTED TO SURFACE BY PROJECT COMBINED SCALE FACTOR 0.9998802448

EXHIBIT "A"
PARCEL 1021

J. DISHMAN SURVEY
ABSTRACT 408

E. DISHMAN
SURVEY
ABSTRACT 407

FINAL PLAT OF
MEADOW CREEK SOUTH
CAB. A, SLIDE, 8822
P.R.T.C.T.
INST. NO. D203450603
O.P.R.T.C.T.

R.O.W. DEDICATION
FINAL PLAT OF
MEADOW CREEK SOUTH
CAB. A, SLIDE, 8822, P.R.T.C.T.
INST. NO. D203450603
O.P.R.T.C.T.

PARCEL 1021
53.719 AC.
2,339,998 SQ.FT.

W. RISINGER RD
VARIABLE WIDTH R.O.W.

SEE SHEET 29

SEE SHEET 31

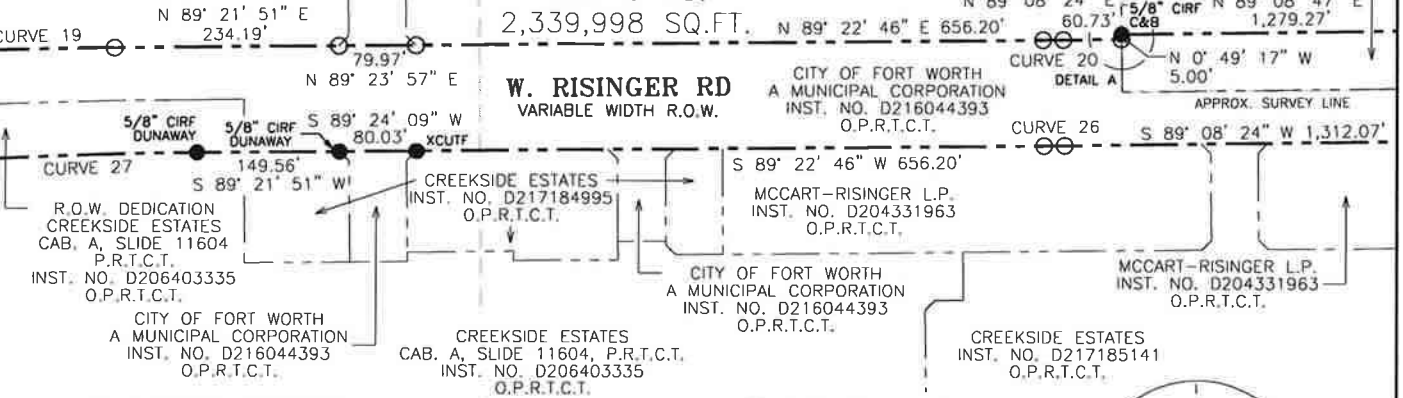

CURVE	DELTA	RADIUS	LENGTH	CHORD BEARING	LONG CHORD
19	6° 30' 34" (RT)	5,055.00	574.30	N 86° 06' 34" E	573.99
20	0° 14' 23" (LT)	4,945.00	20.69	N 89° 15' 35" E	20.69
26	0° 14' 23" (RT)	5,055.00	21.15	S 89° 15' 35" W	21.15
27	7° 04' 47" (LT)	4,945.00	611.03	S 85° 49' 28" W	610.64

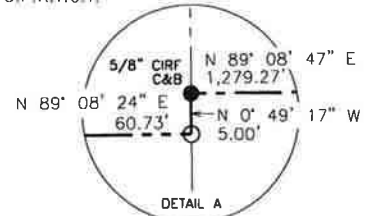

NOTE: LEGAL DESCRIPTION TO ACCOMPANY THIS PLAT.

LEGEND

- = MARKER FOUND AS NOTED
- = 5/8" CIRS STAMPED TRANSYSTEMS

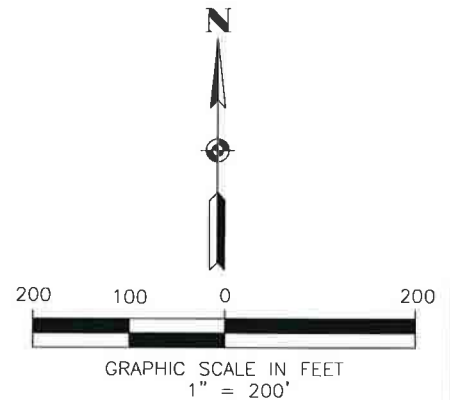

TranSystems

500 WEST SEVENTH STREET
SUITE 1100
FORT WORTH, TX 76102
(817) 339-8950 (TEL)
(817) 549-7524 (FAX)
TX SURV FIRM NO. 10038300

PROJ NO:	P202090330
SCALE:	1" = 200'
DATE:	12-14-2020
DRAWN BY:	DMP
CHECKED BY:	KDE
REVISED DATE:	5-14-2021

PRINTED ON:
5/14/2021
12:28:11 PM

DANIEL M. PUTMAN
6729
PROFESSIONAL
LAND SURVEYOR

SHEET TITLE
EXHIBIT "A"
SEGMENT 9, PARCEL 1021
WEST RISINGER ROAD

PROJECT
INTEGRATED PIPELINE PROJECT

BASIS OF BEARING IS THE TEXAS COORDINATE SYSTEM OF 1983, NORTH CENTRAL ZONE (4202), NORTH AMERICAN DATUM 1983 (NAD83)(2007) WITH ALL DISTANCES ADJUSTED TO SURFACE BY PROJECT COMBINED SCALE FACTOR 0.9998802448

EXHIBIT "A"
PARCEL 1021

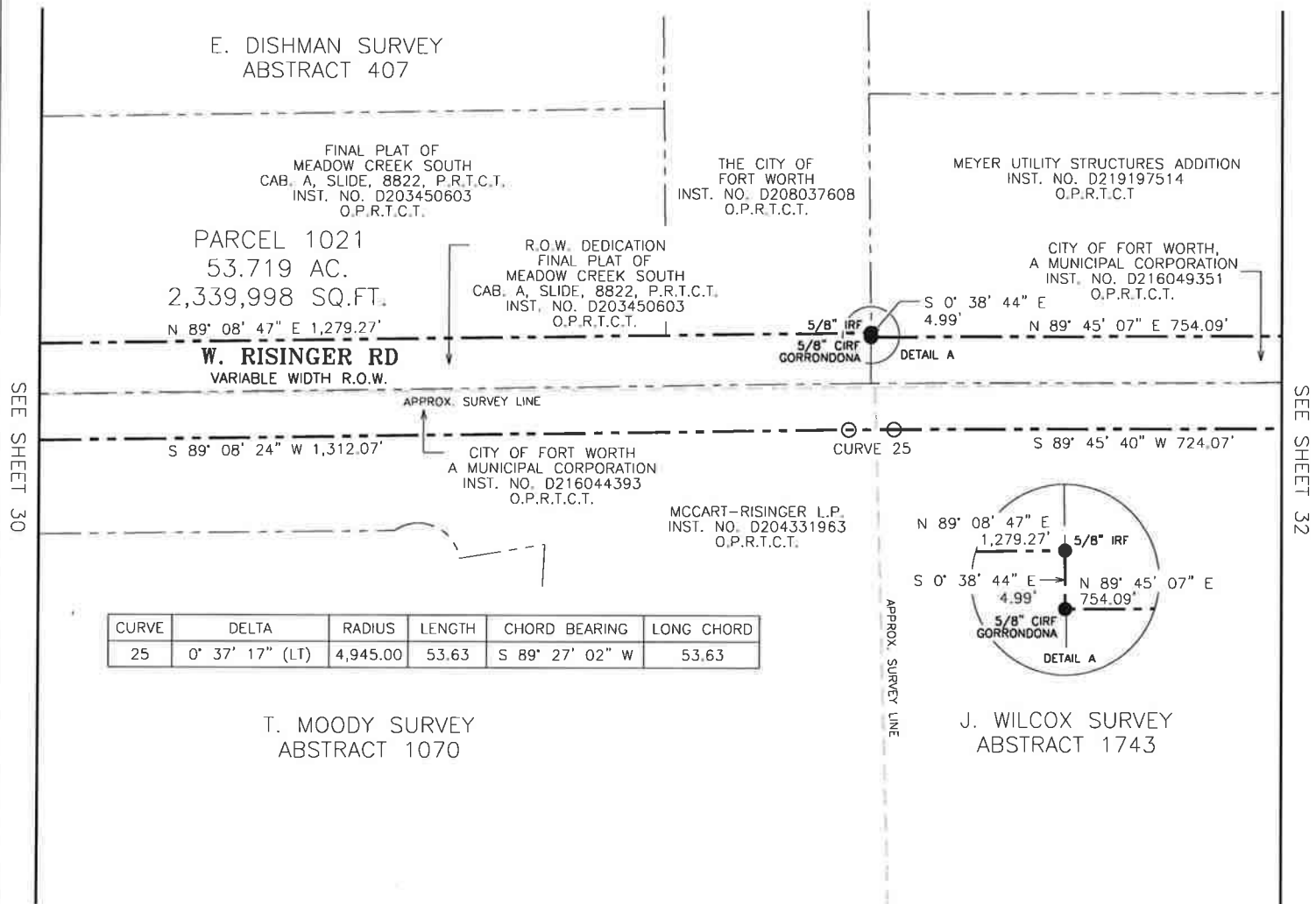

CURVE	DELTA	RADIUS	LENGTH	CHORD BEARING	LONG CHORD
25	0° 37' 17" (LT)	4,945.00	53.63	S 89° 27' 02" W	53.63

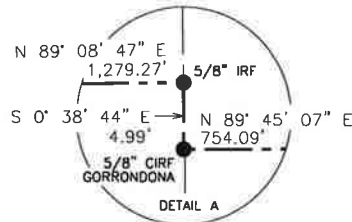

T. MOODY SURVEY
ABSTRACT 1070

NOTE: LEGAL DESCRIPTION TO ACCOMPANY THIS PLAT.

LEGEND

- = MARKER FOUND AS NOTED
- = 5/8" CIRS STAMPED TRANSYSTEMS

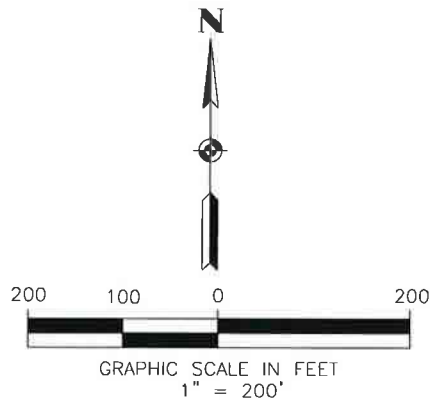

TranSystems

500 WEST SEVENTH STREET
SUITE 1100
FORT WORTH, TX 76102
(817) 339-8950 (TEL)
(817) 549-7524 (FAX)
TX SURV FIRM NO. 10038300

PROJ NO: P202090330
SCALE: 1" = 200'
DATE: 12-14-2020
DRAWN BY: DMP
CHECKED BY: KDE
REVISED DATE: 5-14-2021

PRINTED ON:
5/14/2021
1:17:18 PM

STATE OF TEXAS
REGISTERED
DANIEL M. PUTMAN
6729
PROFESSIONAL
LAND SURVEYOR

SHEET TITLE

EXHIBIT "A"
SEGMENT 9, PARCEL 1021
WEST RISINGER ROAD

PROJECT

INTEGRATED PIPELINE PROJECT

BASIS OF BEARING IS THE TEXAS COORDINATE SYSTEM OF 1983,
NORTH CENTRAL ZONE (4202), NORTH AMERICAN DATUM 1983
(NAD83)(2007) WITH ALL DISTANCES ADJUSTED TO SURFACE BY
PROJECT COMBINED SCALE FACTOR 0.9998802448

EXHIBIT "A"
PARCEL 1021

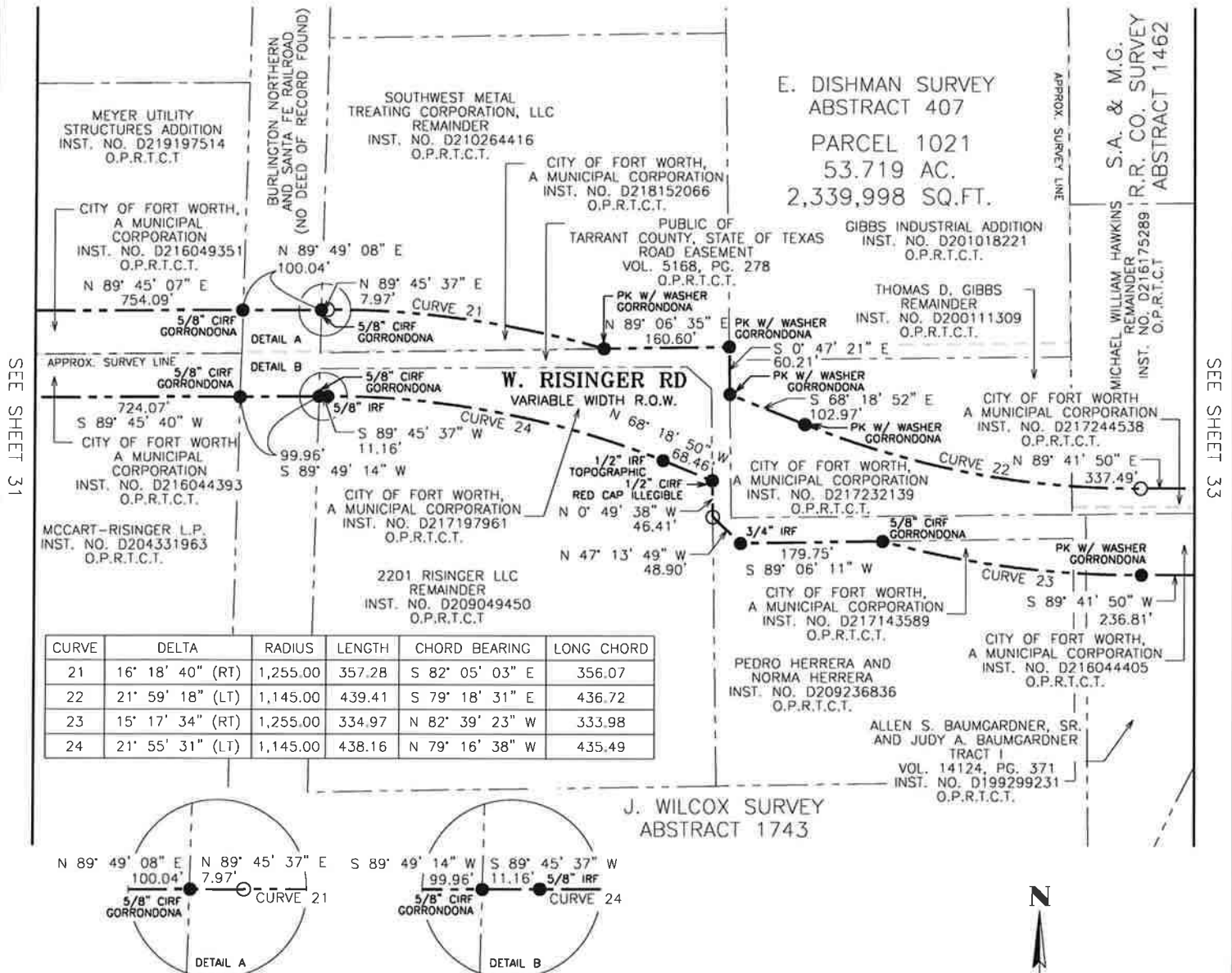

CURVE	DELTA	RADIUS	LENGTH	CHORD BEARING	LONG CHORD
21	16° 18' 40" (RT)	1,255.00	357.28	S 82° 05' 03" E	356.07
22	21° 59' 18" (LT)	1,145.00	439.41	S 79° 18' 31" E	436.72
23	15° 17' 34" (RT)	1,255.00	334.97	N 82° 39' 23" W	333.98
24	21° 55' 31" (LT)	1,145.00	438.16	N 79° 16' 38" W	435.49

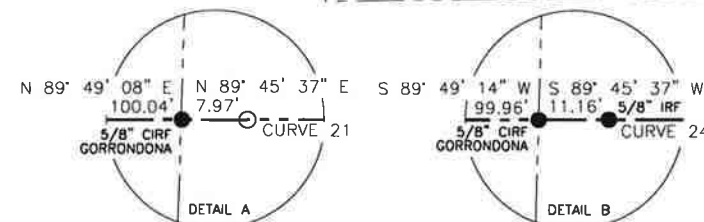

NOTE: LEGAL DESCRIPTION TO ACCOMPANY THIS PLAT.

LEGEND

- = MARKER FOUND AS NOTED
- = 5/8" CIRS STAMPED TRANSYSTEMS

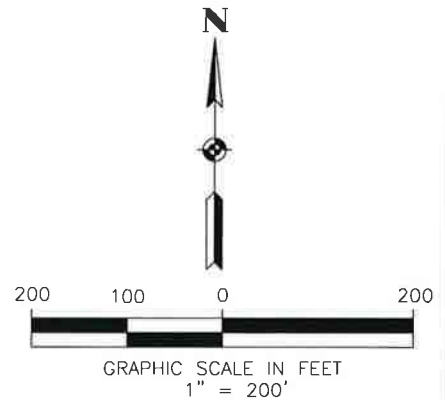

TranSystems

500 WEST SEVENTH STREET
SUITE 1100
FORT WORTH, TX 76102
(817) 339-8950 (TEL)
(817) 549-7524 (FAX)
TX SURV FIRM NO. 10038300

PROJ NO:	P202090330
SCALE:	1" = 200'
DATE:	12-14-2020
DRAWN BY:	DMP
CHECKED BY:	KDE
REVISED DATE:	5-14-2021

PRINTED ON:
5/14/2021
12:13 PM

Daniel M. Putman

SHEET TITLE
EXHIBIT "A"
SEGMENT 9, PARCEL 1021
WEST RISINGER ROAD

PROJECT
INTEGRATED PIPELINE PROJECT

BASIS OF BEARING IS THE TEXAS COORDINATE SYSTEM OF 1983, NORTH CENTRAL ZONE (4202), NORTH AMERICAN DATUM 1983 (NAD83)(2007) WITH ALL DISTANCES ADJUSTED TO SURFACE BY PROJECT COMBINED SCALE FACTOR 0.9998802448

EXHIBIT "A"
PARCEL 1021

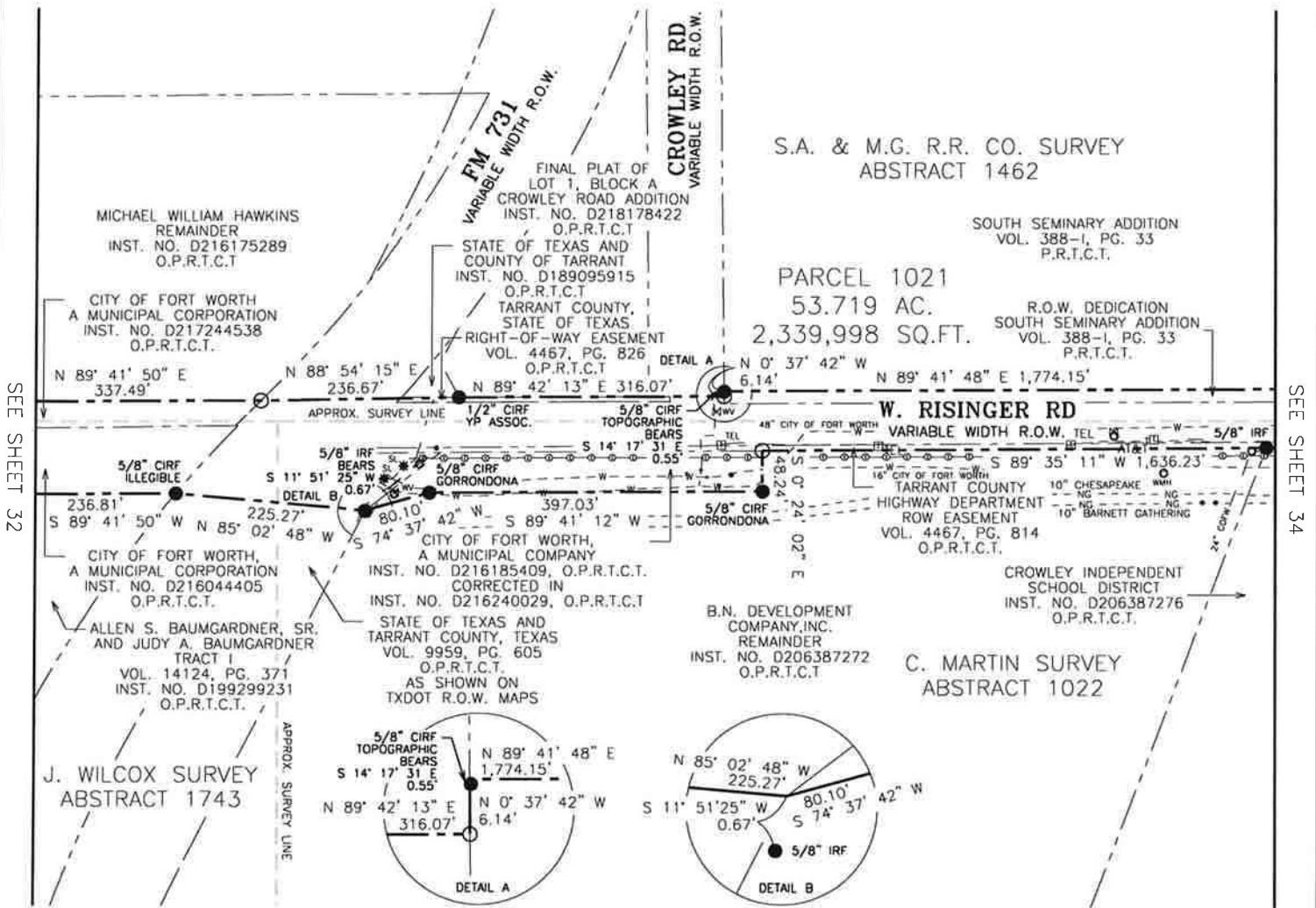

SEE SHEET 32

SEE SHEET 34

- NOTES:
1. KNOWN UNDERGROUND UTILITIES SHOWN ARE QUALITY LEVEL B AND D SUE (09-20-2016).
 2. LEGAL DESCRIPTION TO ACCOMPANY THIS PLAT.

LEGEND

- = MARKER FOUND AS NOTED
- = 5/8" CIRS STAMPED TRANSYSTEMS

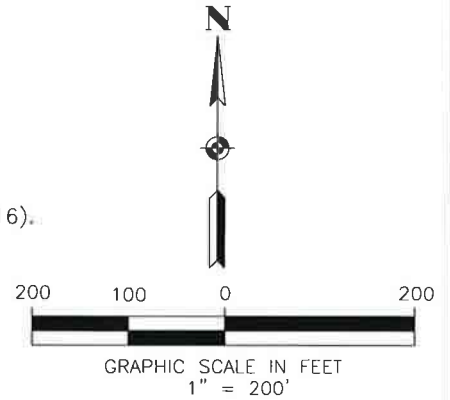

TranSystems

500 WEST SEVENTH STREET
SUITE 1100
FORT WORTH, TX 76102
(817) 339-8950 (TEL)
(817) 549-7524 (FAX)
TX SURV FIRM NO. 10038300

PROJ NO:	P202090330
SCALE:	1" = 200'
DATE:	12-14-2020
DRAWN BY:	DMP
CHECKED BY:	KDE
REVISED DATE:	5-14-2021

PRINTED ON:
5/14/2021
12:30 PM

STATE OF TEXAS
REGISTERED
DANIEL M. PUTMAN
6729
PROFESSIONAL
LAND SURVEYOR

SHEET TITLE	EXHIBIT "A" SEGMENT 9, PARCEL 1021 WEST RISINGER ROAD
PROJECT	INTEGRATED PIPELINE PROJECT
BASIS OF BEARING IS THE TEXAS COORDINATE SYSTEM OF 1983, NORTH CENTRAL ZONE (4202), NORTH AMERICAN DATUM 1983 (NAD83)(2007) WITH ALL DISTANCES ADJUSTED TO SURFACE BY PROJECT COMBINED SCALE FACTOR 0.9998802448	

EXHIBIT "A"
PARCEL 1021

S.A. & M.G. R.R. SURVEY
ABSTRACT 1462

SOUTH SEMINARY ADDITION
VOL. 388-1, PG. 33
P.R.T.C.T.

CHRISTOPHER R. WILSHIRE
INST. NO. D214106604
O.P.R.T.C.T.

WILLSHIRE FARM, LLC
INST. NO. D214099817
O.P.R.T.C.T.

TARRANT COUNTY, STATE OF TEXAS
R.O.W. EASEMENT
VOL. 4467, PG. 816
O.P.R.T.C.T.

PARCEL 1021
53.719 AC.
2,339,998 SQ.FT.

R.O.W. DEDICATION
SOUTH SEMINARY ADDITION
VOL. 388-1, PG. 33
P.R.T.C.T.

S 0° 26' 12" E
11.37'

N 89° 47' 14" E
250.05'

S 3° 05' 10" E
30.66'

SEE SHEET 33

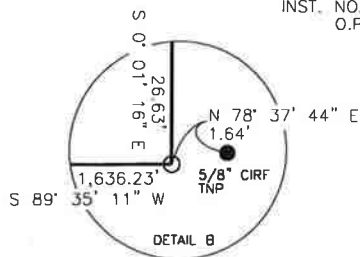
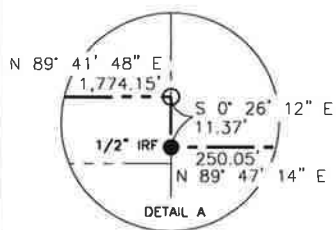
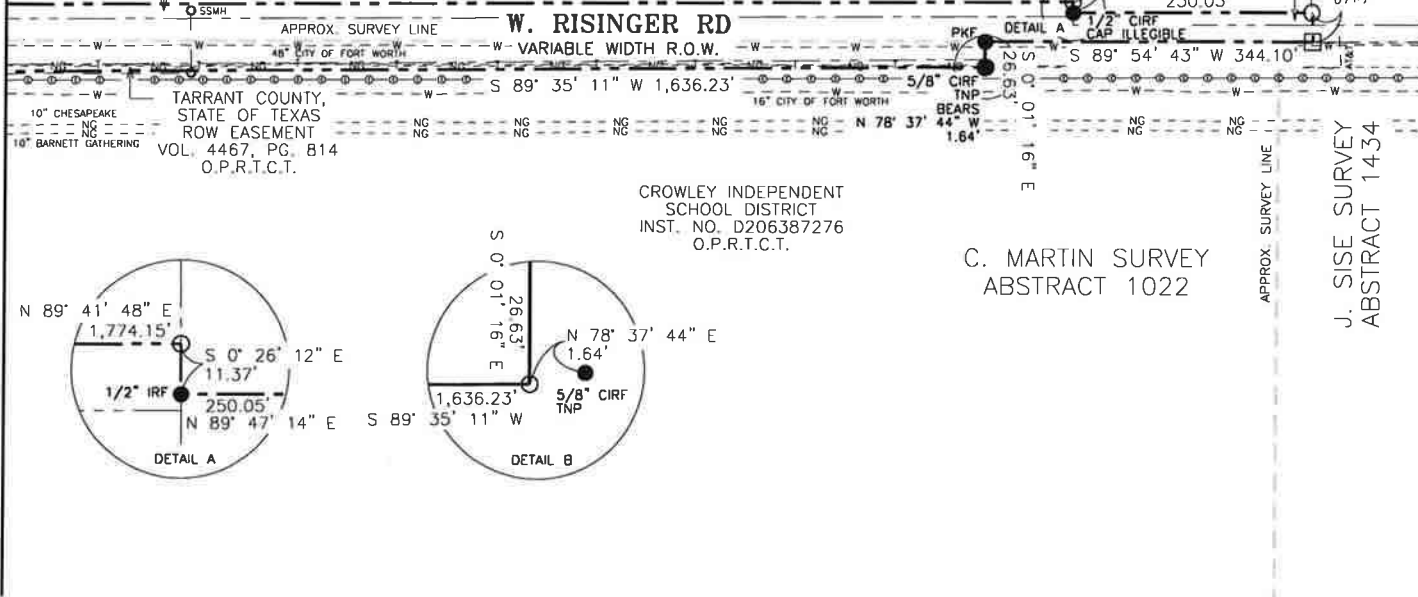

- NOTES:
1. KNOWN UNDERGROUND UTILITIES SHOWN ARE QUALITY LEVEL B AND D SUE (09-20-2016).
2. LEGAL DESCRIPTION TO ACCOMPANY THIS PLAT.

LEGEND

- = MARKER FOUND AS NOTED
- = 5/8" CIRS STAMPED TRANSYSTEMS
- = PK NAIL SET

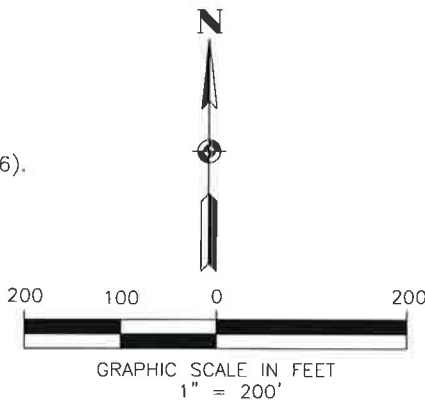

500 WEST SEVENTH STREET
SUITE 1100
FORT WORTH, TX 76102
(817) 339-8950 (TEL)
(817) 549-7524 (FAX)
TX SURV FIRM NO. 10038300

PRINTED ON:
5/14/2020
1:24 PM

Daniel M. Putman

SHEET TITLE
EXHIBIT "A"
SEGMENT 9, PARCEL 1021
WEST RISINGER ROAD

PROJECT
INTEGRATED PIPELINE PROJECT

BASIS OF BEARING IS THE TEXAS COORDINATE SYSTEM OF 1983, NORTH CENTRAL ZONE (4202), NORTH AMERICAN DATUM 1983 (NAD83)(2007) WITH ALL DISTANCES ADJUSTED TO SURFACE BY PROJECT COMBINED SCALE FACTOR 0.9998802448

PROJ NO:	P202090330
SCALE:	1" = 200'
DATE:	12-14-2020
DRAWN BY:	DMP
CHECKED BY:	KDE
REVISED DATE:	5-14-2021

In addition, the General Manager of TRWD or his designee is authorized to take all steps as may be reasonable and necessary to facilitate acquisition of the above-described properties for the IPL Project, with title to be held in the name of TRWD, and in connection therewith to pay all reasonable and necessary costs incurred with such acquisition. Funding for this item is included in the Bond Fund. Director Leonard seconded the motion, and the votes were 5 in favor, 0 against.

21.

With the recommendation of management and outside counsel, Director Kelleher moved to authorize the exchange of the following described land:

TRWD will partially release its floodway easement covering an approximately .5987-acre tract of land over part of Lot 1, Block 1, Trinity River Addition, an Addition to the City of Fort Worth as shown on the Plat Recorded in Cabinet B, Slide 2904, Plat Records, Tarrant County, Texas, such tract of land being further described and depicted on the survey attached as Exhibit "1" to the accompanying resolution, such survey being incorporated herein by reference (the "Release Property").

Summit Land Development, LLC, a Delaware limited liability company ("Summit"), will convey to TRWD a fee simple title to the surface estate only of a 0.6778-acre tract of land, being part of a floodway easement described in deed to Tarrant County Water Control and Improvement District No. 1 as Recorded in volume 2285, page 188, Deed Records, Tarrant County, Texas and being part of Lot 1, block 1, Trinity river Addition, an Addition to the City of Fort Worth as shown on the plat recorded in Cabinet B, slide 2904, Plat Records, Tarrant County, Texas, such tract of land being more particularly described and depicted on the survey attached as Exhibit "2" to the accompanying resolution, such survey being incorporated herein by reference (the "Fee Property").

In addition to the conveyance of the Fee Property, Summit will pay all closing costs.

EXHIBIT "1"

See attached.

EXHIBIT "A"
EASEMENT RELEASE
0.5987 ACRES/26,080 SQ. FT.

BEING A 0.5987 ACRE (26,080 SQUARE FOOT) TRACT OF LAND, BEING PART OF FLOODWAY EASEMENT DESCRIBED IN DEED TO TARRANT COUNTY WATER CONTROL AND IMPROVEMENT DISTRICT No. 1 AS RECORDED IN VOLUME 2285, PAGE 188, DEED RECORDS, TARRANT COUNTY, TEXAS AND BEING PART OF LOT 1, BLOCK 1, TRINITY RIVER ADDITION, AN ADDITION TO THE CITY OF FORT WORTH AS SHOWN ON THE PLAT RECORDED IN CABINET B, SLIDE 2904, PLAT RECORDS, TARRANT COUNTY, TEXAS. SAID 0.5987 ACRE TRACT BEING MORE PARTICULARLY DESCRIBED BY METES AND BOUNDS AS FOLLOWS:

(BEARINGS AND COORDINATES ARE GRID BASED ON THE "TEXAS COORDINATE SYSTEM OF 1983, NORTH CENTRAL ZONE" AS DETERMINED BY GPS OBSERVATIONS. THE CONVERGENCE ANGLE AT THE POINT OF COMMENCING IS 0°38'55.7". THE DISTANCES SHOWN WERE ADJUSTED TO SURFACE USING A COMBINED SCALE FACTOR OF 1.000136772746)

COMMENCING AT A 5/8" YELLOW PLASTIC CAPPED IRON STAMPED "MMA" PREVIOUSLY SET (N: 6,964,700.03, E: 2,334,141.70) FOR THE NORTH CORNER OF SAID LOT 1 AND BEING IN THE SOUTHEAST RIGHT-OF-WAY LINE OF EAST BELKNAP STREET (VARIABLE WIDTH PUBLIC RIGHT-OF-WAY);

THENCE, SOUTH 59°28'14" WEST, WITH THE COMMON NORTHWEST BOUNDARY LINE OF SAID LOT 1 AND SAID SOUTHEAST RIGHT-OF-WAY LINE, A DISTANCE OF 246.92 FEET TO THE POINT OF BEGINNING AND BEING AT THE INTERSECTION OF SAID COMMON LINE WITH THE NORTHEAST EASEMENT LINE OF SAID FLOODWAY EASEMENT;

THENCE, SOUTH 18°32'14" EAST, WITH SAID NORTHEAST EASEMENT LINE, OVER AND ACROSS SAID LOT 1, A DISTANCE OF 233.76 FEET TO A POINT IN THE COMMON SOUTHEAST BOUNDARY LINE OF SAID LOT 1 AND THE NORTHWEST RIGHT-OF-WAY LINE OF AIRPORT FREEWAY/STATE HIGHWAY No. 121 (VARIABLE WIDTH PUBLIC RIGHT-OF-WAY) AND THE BEGINNING OF A NON-TANGENT CURVE TO THE LEFT HAVING A RADIUS OF 4024.72 FEET, A DELTA ANGLE OF 01°40'35" AND A LONG CHORD BEARING AND DISTANCE OF SOUTH 80°53'02" WEST, 117.74 FEET;

THENCE, SOUTHWESTERLY, WITH SAID COMMON LINE AND SAID NON-TANGENT CURVE TO THE LEFT, AN ARC-DISTANCE OF 117.75 FEET TO A POINT FROM WHICH A 1/2" CAPPED IRON ROD FOUND STAMPED "CBG SURVEY" FOR THE SOUTH CORNER OF SAID LOT 1 BEARS SOUTH 78°47'55" WEST, A DISTANCE OF 175.20 FEET;

THENCE, OVER AND ACROSS SAID FLOODWAY EASEMENT AND SAID LOT 1 THE FOLLOWING TWO (2) COURSES AND DISTANCES:

NORTH 28°04'10" WEST, A DISTANCE OF 35.17 FEET TO A POINT, AND

NORTH 21°01'51" WEST, A DISTANCE OF 152.62 FEET TO A POINT IN THE COMMON NORTHWEST BOUNDARY LINE OF SAID LOT 1 AND THE AFORESAID SOUTHEAST RIGHT-OF-WAY LINE;

THENCE, NORTH 59°28'14" EAST, WITH SAID COMMON LINE, A DISTANCE OF 131.49 FEET TO THE **POINT OF BEGINNING** AND BEING 0.5987 ACRES OR 26,080 SQUARE FEET OF LAND, MORE OR LESS.



Timothy A. Nold 5658

2/8/2023

TIMOTHY A. NOLD
REGISTERED PROFESSIONAL LAND SURVEYOR
TEXAS REGISTRATION No. 5658

DATE

EXHIBIT "A"

TRINITY RIVER FLOODWAY EASEMENT

PART OF LOT 1, BLOCK 1, TRINITY RIVER ADDITION, AN ADDITION TO THE CITY OF FORT WORTH, TARRANT COUNTY, TEXAS, ACCORDING TO THE PLAT RECORDED IN CABINET B, SLIDE 2904, PLAT RECORDS, TARRANT COUNTY, TEXAS

PLOTTED BY: JENNIFER STORZ DATE: 2/7/2023 1:56 PM PATH: P:\3402-00-01\500 Land Surveying\506 Easements\Easement Release\3402-00-01 PARTIAL ESMT RELEASE.dwg

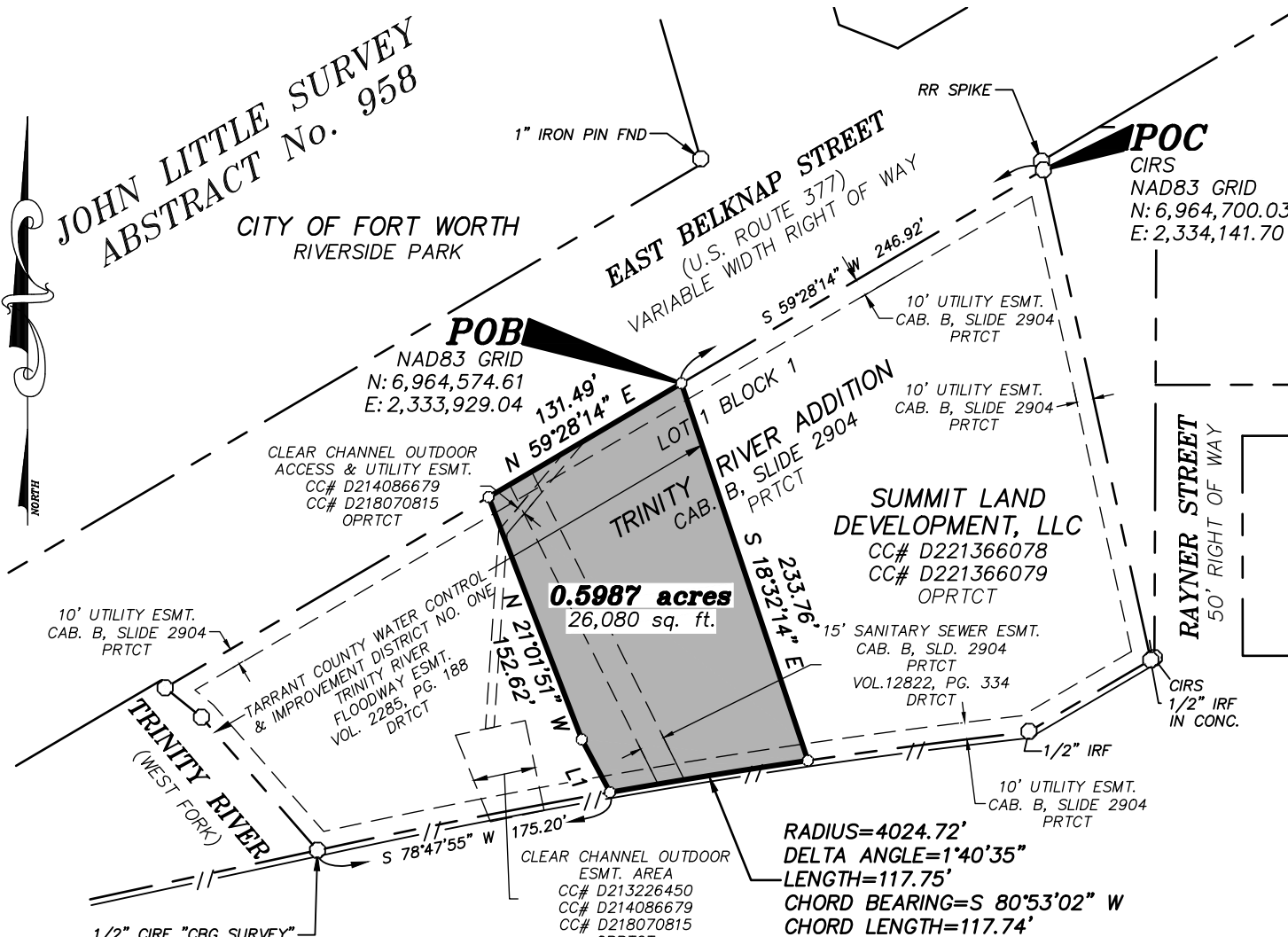

ABBREVIATIONS

- POC POINT OF COMMENCING
- POB POINT OF BEGINNING
- IRF IRON ROD FOUND
- CIRS 5/8" YELLOW PLASTIC CAPPED IRON ROD SET STAMPED "MMA"
- MNS MAG NAIL SET
- CIRF CAPPED IRON ROD FOUND
- OPRTCT OFFICIAL PUBLIC RECORDS, TARRANT COUNTY, TEXAS
- PRTCT PLAT RECORDS, TARRANT COUNTY, TEXAS
- ESMT. EASEMENT
- // - HIGHWAY ACCESS PROHIBITED

BEARINGS AND COORDINATES ARE GRID BASED ON THE "TEXAS COORDINATE SYSTEM OF 1983, NORTH CENTRAL ZONE" AS DETERMINED BY GPS OBSERVATIONS. THE CONVERGENCE ANGLE AT THE POINT OF COMMENCING IS 0°38'55.7". ALL DISTANCES HAVE BEEN ADJUSTED TO SURFACE USING A COMBINED SCALE FACTOR OF 1.000136772746.

LINE TABLE		
LINE	BEARING	DISTANCE
L1	N 28°04'10" W	35.17'



civil engineering surveying landscape architecture planning

tbpels registration number: f - 2759
 tbpels registration/license number: 10088000

519 east border
 arlington, texas 76010
 817-469-1671
 fax: 817-274-8757
 www.mmatexas.com

EXHIBIT "2"

See attached.

EXHIBIT "A"
FLOODWAY EASEMENT
0.6778 ACRES/29,523 SQ. FT.

BEING A 0.6778 ACRE (29,523 SQUARE FOOT) TRACT OF LAND, BEING PART OF A FLOODWAY EASEMENT DESCRIBED IN DEED TO TARRANT COUNTY WATER CONTROL AND IMPROVEMENT DISTRICT No. 1 AS RECORDED IN VOLUME 2285, PAGE 188, DEED RECORDS, TARRANT COUNTY, TEXAS AND BEING PART OF LOT 1, BLOCK 1, TRINITY RIVER ADDITION, AN ADDITION TO THE CITY OF FORT WORTH AS SHOWN ON THE PLAT RECORDED IN CABINET B, SLIDE 2904, PLAT RECORDS, TARRANT COUNTY, TEXAS. SAID 0.6778 ACRE TRACT BEING MORE PARTICULARLY DESCRIBED BY METES AND BOUNDS AS FOLLOWS:

(BEARINGS AND COORDINATES ARE GRID BASED ON THE "TEXAS COORDINATE SYSTEM OF 1983, NORTH CENTRAL ZONE" AS DETERMINED BY GPS OBSERVATIONS. THE CONVERGENCE ANGLE AT THE POINT OF COMMENCING IS 0°38'55.7". THE DISTANCES SHOWN WERE ADJUSTED TO SURFACE USING A COMBINED SCALE FACTOR OF 1.000136772746)

COMMENCING AT A 5/8" YELLOW PLASTIC CAPPED IRON STAMPED "MMA" PREVIOUSLY SET (N: 6,964,700.03, E: 2,334,141.70) FOR THE NORTH CORNER OF SAID LOT 1 AND BEING IN THE SOUTHEAST RIGHT-OF-WAY LINE OF EAST BELKNAP STREET (VARIABLE WIDTH PUBLIC RIGHT-OF-WAY);

THENCE, SOUTH 59°28'14" WEST, WITH THE COMMON NORTHWEST BOUNDARY LINE OF SAID LOT 1 AND SAID SOUTHEAST RIGHT-OF-WAY LINE, A DISTANCE OF 378.42 FEET TO THE **POINT OF BEGINNING** (N: 6,964,507.83, E: 2,333,815.79);

THENCE, OVER AND ACROSS SAID FLOODWAY EASEMENT AND SAID LOT 1 THE FOLLOWING TWO (2) COURSES AND DISTANCES:

SOUTH 21°01'51" EAST, A DISTANCE OF 152.62 FEET TO A POINT, AND

SOUTH 28°04'10" EAST, A DISTANCE OF 35.17 FEET TO A POINT IN THE COMMON SOUTHEAST BOUNDARY LINE OF SAID LOT 1 AND THE NORTHWEST RIGHT-OF-WAY LINE OF AIRPORT FREEWAY/STATE HIGHWAY No. 121 (VARIABLE WIDTH PUBLIC RIGHT-OF-WAY) AND THE BEGINNING OF A NON-TANGENT CURVE TO THE LEFT HAVING A RADIUS OF 4024.72, A DELTA ANGLE OF 2°29'40" AND A LONG CHORD BEARING AND DISTANCE OF SOUTH 78°47'55" WEST, 175.20 FEET;

THENCE, SOUTHWESTERLY, WITH SAID COMMON LINE AND SAID NON-TANGENT CURVE TO THE LEFT, AN ARC-DISTANCE OF 175.21 FEET TO A 1/2" CAPPED IRON ROD FOUND STAMPED "CBG SURVEY" FOR THE SOUTH CORNER OF SAID LOT 1 AND BEING ON THE BANK OF THE WEST FORK OF THE TRINITY RIVER;

THENCE, WITH THE COMMON SOUTHWEST BOUNDARY LINE OF SAID LOT 1 AND SAID RIVER BANK THE FOLLOWING TWO (2) COURSES AND DISTANCES:

NORTH 41°06'03" WEST, A DISTANCE OF 103.73 FEET TO A 5/8" YELLOW PLASTIC CAPPED IRON STAMPED "MMA" PREVIOUSLY SET, AND

NORTH 50°58'51" WEST, A DISTANCE OF 27.44 FEET TO A 5/8" YELLOW PLASTIC CAPPED IRON STAMPED "MMA" PREVIOUSLY SET FOR THE WEST CORNER OF SAID LOT 1 AND BEING IN THE AFORESAID SOUTHEAST RIGHT-OF-WAY LINE;

THENCE, NORTH 59°28'14" EAST, WITH THE COMMON NORTHWEST BOUNDARY LINE OF SAID LOT 1 AND SAID SOUTHEAST RIGHT-OF-WAY LINE, A DISTANCE OF 220.64 FEET TO THE **POINT OF BEGINNING** AND BEING 0.6778 ACRES OR 29,523 SQUARE FEET OF LAND, MORE OR LESS.



Timothy A. Nold 5270

2/8/2023

TIMOTHY A. NOLD
REGISTERED PROFESSIONAL LAND SURVEYOR
TEXAS REGISTRATION No. 5658

DATE



519 east border
arlington, texas 76010
817-469-1671
TNold@mmatexas.com

EXHIBIT "A"

TRINITY RIVER FLOODWAY EASEMENT

PART OF LOT 1, BLOCK 1, TRINITY RIVER ADDITION, AN ADDITION TO THE CITY OF FORT WORTH, TARRANT COUNTY, TEXAS, ACCORDING TO THE PLAT RECORDED IN CABINET B, SLIDE 2904, PLAT RECORDS, TARRANT COUNTY, TEXAS

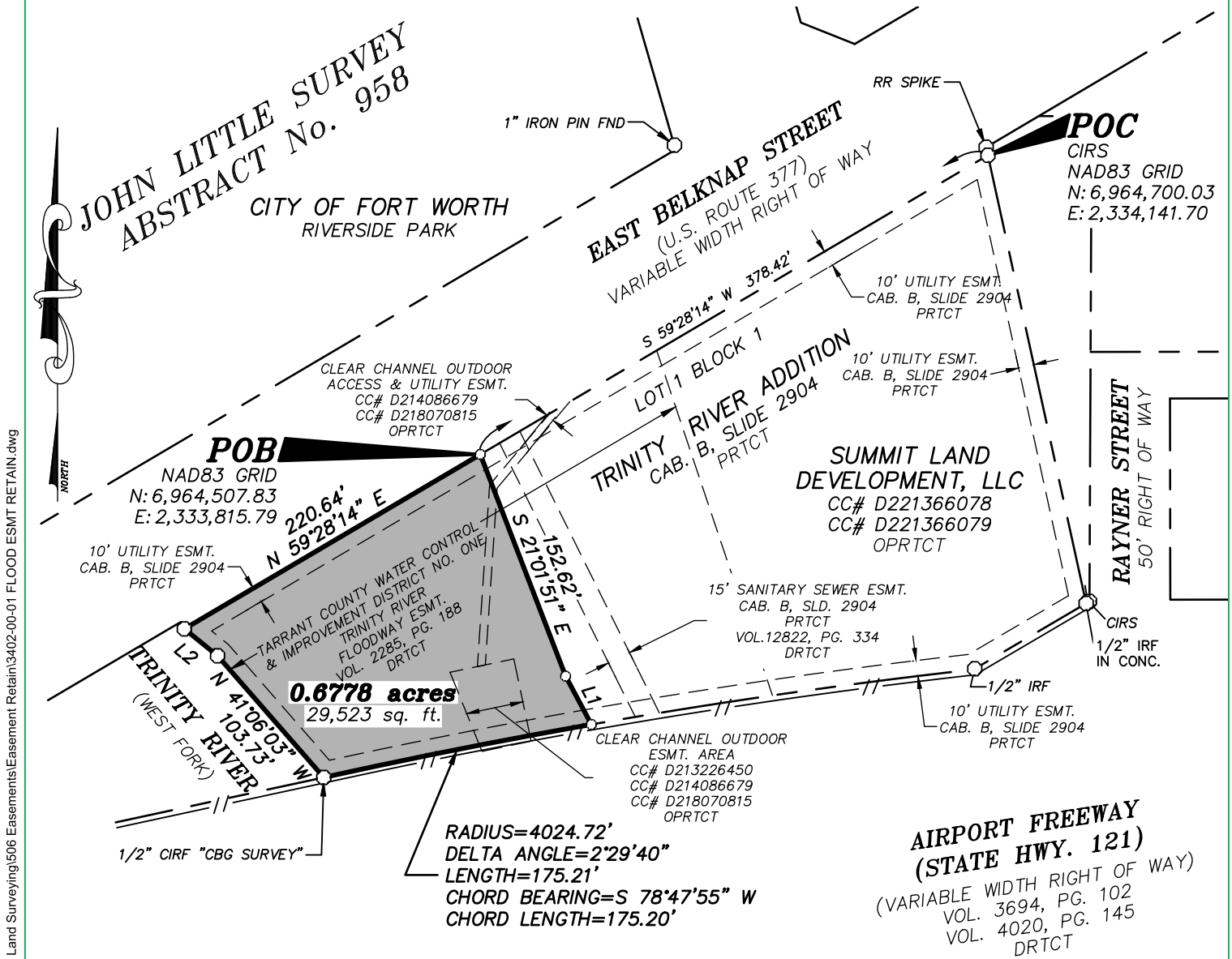

ABBREVIATIONS

- POC POINT OF COMMENCING
- POB POINT OF BEGINNING
- IRF IRON ROD FOUND
- CIRS 5/8" YELLOW PLASTIC CAPPED IRON ROD SET STAMPED "MMA"
- MNS MAG NAIL SET
- CIRF CAPPED IRON ROD FOUND
- OPRTCT OFFICIAL PUBLIC RECORDS, TARRANT COUNTY, TEXAS
- PRTCT PLAT RECORDS, TARRANT COUNTY, TEXAS
- ESMT. EASEMENT
- // - HIGHWAY ACCESS PROHIBITED

LINE TABLE		
LINE	BEARING	DISTANCE
L1	S 28°04'10" E	35.17'
L2	N 50°58'51" W	27.44'



civil engineering surveying landscape architecture planning

tbpels registration number: f - 2759
 tbpels registration/license number: 10088000
 519 east border
 arlington, texas 76010
 817-469-1671
 fax: 817-274-8757
 www.mmatexas.com

BEARINGS AND COORDINATES ARE GRID BASED ON THE "TEXAS COORDINATE SYSTEM OF 1983, NORTH CENTRAL ZONE" AS DETERMINED BY GPS OBSERVATIONS. THE CONVERGENCE ANGLE AT THE POINT OF COMMENCING IS 0°38'55.7". ALL DISTANCES HAVE BEEN ADJUSTED TO SURFACE USING A COMBINED SCALE FACTOR OF 1.000136772746.

DATE: 02/07/2023 SCALE: 1" = 100' DRAWN BY: JMS CHECKED BY: TAN JOB. NO.: 3402-00-01

PLOTTED BY: JENNIFER STORZ DATE: 2/7/2023 1:37 PM PATH: P:\3402-00-01\500 Land Surveying\506 Easements\Easement Retain\3402-00-01 FLOOD ESMT RETAIN.dwg

In addition, the General Manager or his designee is authorized to take all steps as may be reasonable and necessary to facilitate the exchange of the above-described property with title to the permanent easement over and across the Fee Property to be held in the name of TRWD, including, without limitation, the execution of an exchange agreement and all conveyance and closing documents. Director Hill seconded the motion, and the votes were 5 in favor, 0 against.

22.

There were no future agenda items approved.

23.

The next board meeting was scheduled for March 21, 2023 at 9:00 a.m.

24.

There being no further business before the Board of Directors, the meeting was adjourned.

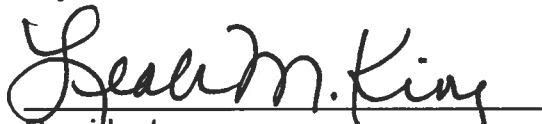

President



Secretary