

MINUTES OF A MEETING OF THE BOARD OF DIRECTORS OF
TARRANT REGIONAL WATER DISTRICT
HELD ON THE 19th DAY OF NOVEMBER 2019 AT 9:00 A.M.

The call of the roll disclosed the presence of the Directors as follows:

Present
Jack Stevens
Marty Leonard
Leah King
James Hill
Jim Lane

Also present were Jim Oliver, Alan Thomas, Dan Buhman, Darrell Beason, Steve Christian, Linda Christie, Samantha Drumm, Jason Gehrig, J.D. Granger, Rachel Ickert, Nancy King, Chad Lorange, Sandy Newby, Tina Nikolic, Matt Oliver, Wayne Owen, and Kirk Thomas of the Tarrant Regional Water District (District or TRWD).

Also in attendance were George Christie, Lee Christie, Ethel Steele, Mike Atchley, and Jeremy Harmon of Pope, Hardwicke, Christie, Schell, Kelly & Taplett, L.L.P., General Counsel for the District; Brooke Goggans of MSP; Molly Carson and Greg Schaecher of McCall, Parkhurst & Horton; Christine Jacoby of Freese and Nichols; John Aughinbaugh of Project Management Associates; Max Baker; C.B. Team of Ellis & Tinsley, Inc; Donald Lange of BGE, Inc; Marice Richter of Fort Worth Business Press; Denis Qualls of Dallas Water Utilities; and Randy Gregg of Whitley Penn, LLP.

President Stevens convened the meeting with assurance from management that all requirements of the "open meetings" laws had been met.

1.

All present were given the opportunity to join in reciting the Pledges of Allegiance to the U.S. and Texas flags.

2.

Public Comment

There were no persons from the general public requesting the opportunity to address the Board of Directors.

3.

On a motion made by Director Lane and seconded by Director King, the Directors voted unanimously to approve the minutes from the Board meeting held on October 15, 2019. It was accordingly ordered that these minutes be placed in the permanent files of the District.

4.

With the recommendation of management, Director Leonard moved to approve a contract with Fibrwrap Construction Services in the amount of \$244,597.60 for repair of two segments of 72" Cedar Creek pipe. Funding for this item is included in the Fiscal Year 2020 Revenue Fund Budget. Director Hill seconded the motion and the vote in favor was unanimous.

5.

With the recommendation of management, Director King moved to approve a contract in the amount of \$195,000 with Texsun Electric for the purchase and installation of electrical feeder cables at Richland-Chambers Lake Pump Station. Funding for this item is included in the Fiscal Year 2020 Revenue Fund Budget - Unbudgeted. Director Leonard seconded the motion and the vote in favor was unanimous.

6.

Trinity River Vision Authority (TRVA) Board Members Jim Oliver and James Hill presented an update regarding the TRVA Board.

7.

Staff Updates

- Recreation Update: Performance of Twin Points
- Strategic Communications Plan Update
- Trinity River Vision Project Funding
- System Status Update

The Board of Directors recessed for a break from 9:53 a.m to 10:06 a.m.

8.

The presiding officer next called an executive session at 10:06 a.m. under Texas Government Code, Section 551.071 to Consult with Legal Counsel on a Matter in Which the Duty of Counsel Under the Texas Disciplinary Rules of Professional Conduct Clearly Conflicts with Chapter 551, Texas Government Code and to Conduct a Private Consultation with Attorneys Regarding Pending or Contemplated Litigation (*Tarrant Regional Water District v. Joe Baxter and Evelyn Trent Baxter*, Cause No. C16-25031-CV in County Court at Law of Navarro County, Texas); Section 551.072 to Deliberate the Purchase, Exchange, Lease or Value of Real Property; and Section 551.074 Regarding Personnel Matters. Upon completion of the executive session at 10:13 a.m., the President reopened the meeting with a quorum present.

9.

With the recommendation of management, Director Lane moved to approve a wellbore subsurface easement in the Thomas S. Mitchell Survey, Abstract No. 488, Henderson County, Texas to O’Ryan Oil and Gas. In addition, the General Manager or his designee are granted authority to execute all documents necessary to complete this transaction. Funding for this item is included in the Fiscal Year 2020 Revenue Fund Budget. Director King seconded the motion and the vote in favor was unanimous.

10.

With the recommendation of management, Director Leonard moved to grant authority to acquire, by purchase, interests in the following described tracts, which are necessary for the public use and purpose of construction and operation of the Cedar Creek Wetland Project. Funding for this item is included in the Bond Fund.

**Parcel 5
(Lacy)**

A permanent easement interest across 1.1107-acre tract of land located in the William S. Campbell Survey, Abstract No. 173, Henderson County, Texas, said 1.1107-acre tract of land also being a portion of a called 20.00-acre tract of land located in said Henderson County, Texas and Kaufman County, Texas, conveyed to John M. Lacy by deed as recorded in Volume 4093, Page 1, Deed Records, Kaufman County, Texas, and being further described in the accompanying resolution and in the survey plat for Parcel 5 attached hereto for the negotiated purchase price of \$10,000;

**Parcel 6
(Lacy)**

A permanent easement interest across 5.9183-acre tract of land located in the William S. Campbell Survey, Abstract No. 112, Kaufman County, Texas, said 5.9183-acre tract of land also being a portion of a called 164.208-acre tract of land conveyed to Sandra Kaye Lacy by deed as recorded in Volume 2441, Page 536, Deed Records, Kaufman County, Texas, and being further described in the accompanying resolution and in the survey plat for Parcel 6 attached hereto for the negotiated purchase price of \$60,000;

**Parcel 10
(Heather)**

A permanent easement interest across a 9.693-acre tract of land located in the Thomas Berry Survey, Abstract No. 71, Henderson County, Texas, said 9.693-acre tract of land also being a portion of a called 135.75-acre tract of land conveyed to Henry Sherman Heather and Fairy Elizabeth Heather Warren, by deed as recorded in Volume 1567, Page 803, Deed Records, Henderson County, Texas, and being further described in the accompanying resolution and in the survey plat for Parcel 10 attached hereto for the appraised value of \$37,000; and

**Parcel 37
(Rankin)**

Permanent easement interests across a 3.8638-acre tract of land and a 1.0784-acre tract of land situated in the John Baker Survey, Abstract No. 17, Kaufman County, Texas, said tracts of land also being portions of a called 9.536-acre tract of land and a called 31.69-acre tract of land conveyed to Michael Glenn Rankin and Sharron R. Rankin described as "Exhibits A-1 and A-2" by deed as recorded in Volume 736, Page 332, Deed Records, Kaufman County, Texas, and being further described in the accompanying resolution and in the survey plats for Parcel 37 attached hereto for the negotiated purchase price of \$54,000;

EXHIBIT "A"
Property Description

BEING a 1.1107 acre (48,382 square feet) tract of land located in the William S. Campbell Survey, Abstract no. 173, Henderson County, Texas, said 1.1107 acre tract of land also being a portion of a called 20.00 acre tract of land located in said Henderson County, Texas and Kaufman County, Texas, conveyed to **JOHN M. LACY**, by deed as recorded in Volume 4093, Page 1, Deed Records, Kaufman County, Texas (D.R.K.C.T.), and being more particularly described by metes and bounds as follows:

COMMENCING at a 1/2 inch iron rod found at the southeast property corner of the said 20.00 acre tract;

THENCE South 89°56'13" West, along the south property line of the said 20.00 acre tract, a distance of 87.18 feet to a 1-1/4 inch iron rod found at the northeast property corner of a called 67.982 acre tract of land conveyed to Robert Heather, by deed as recorded in Instrument No. 2013-00007271, Deed Records, Henderson County, Texas;

THENCE North 89°59'19" West, continuing along the said south property line and along a north property line of the said 67.982 acre tract, a distance of 1,244.69 feet to the southwest property corner of the said 20.00 acre tract, same being an interior property corner of the said 67.982 acre tract;

THENCE North 09°44'34" West, along the west property line of the said 20.00 acre tract and along an east property line of the said 67.982 acre tract, a distance of 486.79 feet to a 5/8 inch iron rod with a cap stamped "SPOONER 5922" set (hereinafter referred to as an iron rod set) at the **POINT OF BEGINNING** of the herein described tract of land (having a grid coordinate of N:6,819,974.260 E:2,623,994.601);

THENCE North 09°44'34" West, continuing along said property lines, a distance of 101.56 feet to an iron rod set from which the northwest property corner of the said 20.00 acre tract, same being a northeast property corner of the said 67.982 acre tract bears North 09°44'34" West, a distance of 16.36 feet;

THENCE departing the said property lines and over and across the said 20.00 acre tract the following courses and distances:

South 89°33'35" East, a distance of 83.81 feet to an iron rod set;

North 86°55'13" East, generally along a fence line, a distance of 288.85 feet to an iron rod set;

North 41°32'29 East, 26.57 feet to a mag nail set on the north property line of the said 20.00 acre tract, same being the south property line of a called 164.208 acre tract conveyed to Sandra Kaye Lacy, by deed thereof filed for record in Volume 2441, Page 536, D.R.K.C.T.;

THENCE North 87°16'55" East, along the said property lines, 139.63 feet to a mag nail set;

THENCE departing the said property lines and over and across the said 20.00 acre tract the following courses and distances:

South 41°32'29" West, a distance of 165.82 feet to an iron rod set;

South 86°55'13" West, a distance of 332.92 feet to an iron rod set;

North 89°33'53" West, a distance of 69.73 feet to the **POINT OF BEGINNING**, and containing **1.1107 acres (48,382 square feet)** of land, more or less.

NOTE: Basis of Bearings is the Texas State Plane Coordinate System, North Central Zone (4202) North American Datum (NAD83)(2007) with all distances scaled from N:6,280,412.879 E:2,638,417.218 by a project combined scale factor of 0.99993245856.

NOTE: Plat to accompany this legal description

I do hereby certify to Fidelity National Title Insurance Company, Attorney's Title Company of Henderson County and Tarrant Regional Water District, that a survey was made on the ground as per the field notes shown on this survey and is true and correct according to the standards of the Texas Society of Professional Surveyors Standards and Specifications for a Category 2, Condition IV Survey, and accurate as to the boundaries and areas of the subject property and the size, location and type of buildings and improvements, if any, and shows the location of all visible easements and rights-of-way and the rights-of-way, easements and other matters of record as listed in Schedule B of the Commitment for Title issued by Fidelity National Title Insurance Company, with an effective date of April 17, 2017, issued date of April 26, 2017, GF No. 13-085-DD, affecting the subject property.

Except as shown on the survey: (i) there are no visible encroachments upon the subject property by visible improvements on adjacent property, (ii) there are no visible encroachments on adjacent property, streets or alleys by any visible improvements on the subject property, and (iii) there are no visible conflicts or discrepancies.

This survey substantially complies with the current Texas Society of Professional Surveyors Standards and Specifications for a Category 2, Condition IV Survey.



10-30-19

Eric S. Spooner
Registered Professional Land Surveyor
Texas Registration Number 5922

Date



EXHIBIT "A" PARCEL 5

LINE TABLE		
NO.	DIRECTION	DIST.
L1	N09°44'34"W	101.56'
L2	S89°33'35"E	83.81'
L3	N86°55'13"E	288.85'
L4	N41°32'29"E	26.57'
L5	N87°16'55"E	139.63'
L6	S41°32'29"W	165.82'
L7	S86°55'13"W	332.92'
L8	N89°33'53"W	69.73'

○ = 5/8" IRON ROD SET WITH CAP
STAMPED "SPOONER 5922" SET
UNLESS OTHERWISE SHOWN.
⊗ = MAG NAIL SET

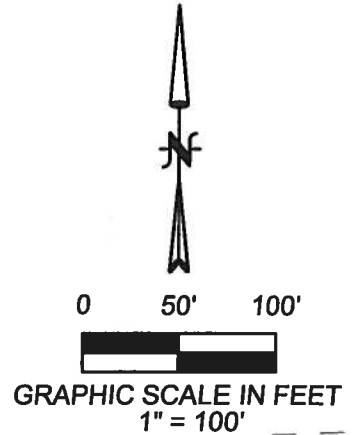

CALLED: 164.208 ACRES
SANDRA KAYE LACY
VOL. 2441, PG. 536,
D.R.K.C.T.

KAUFMAN COUNTY

PARCEL 6

(VARIABLE WIDTH R.O.W.)
COUNTY ROAD NO. 4072

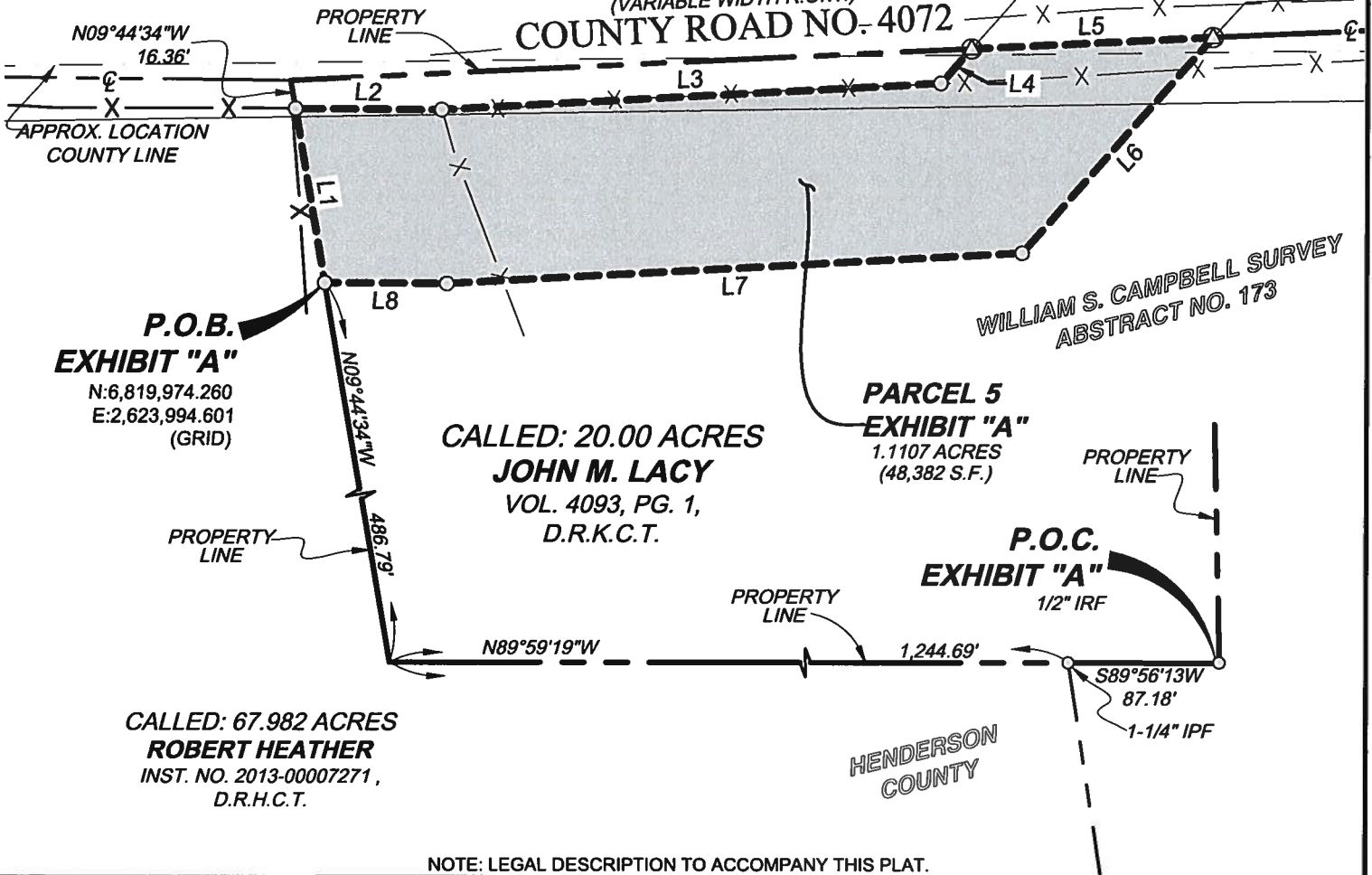

NOTE: LEGAL DESCRIPTION TO ACCOMPANY THIS PLAT.

SPOONER & ASSOCIATES
REGISTERED PROFESSIONAL LAND SURVEYORS
SPOONER AND ASSOCIATES, INC.
309 BYERS STREET, SUITE 100
EULESS, TEXAS 76039
TEL 817-281-2355
FAX 817-685-8508

PROJ NO: 09-086-3
SCALE: 1" = 100'
DATE: 5/4/2013
DRAWN BY: C.R.R.
CHECKED BY: E.S.S.
REVISED DATE: 10-30-19

10-30-19

ERIC S. SPOONER
5922
PROFESSIONAL
LAND SURVEYOR

SHEET TITLE **EXHIBIT "A"**

**PARCEL 5
JOHN M. LACY**

PROJECT CEDAR CREEK
FINISHED WATER PIPELINE

BASIS OF BEARING IS THE TEXAS STATE PLANE COORDINATE SYSTEM, NORTH CENTRAL ZONE (4202) NORTH AMERICAN DATUM (NAD83)(2007) WITH ALL DISTANCES SCALED FROM N:8,820,412.879, E: 2,638,417.218 BY A PROJECT COMBINED SCALE FACTOR OF 0.99993245856.

PG. 3 OF 4

EXHIBIT "A"
Property Description

BEING a 5.9183 acre (257,803 square feet) tract of land located in the William S. Campbell Survey, Abstract No. 112, Kaufman County, Texas, said 5.9183 acre tract of land also being a portion of a called 164.208 acre tract of land conveyed to **SANDRA KAYE LACY**, by deed as recorded in Volume 2441, Page 536, Deed Records, Kaufman County, Texas (D.R.K.C.T.), said 5.9183 acre tract being more particularly described by metes and bounds as follows:

COMMENCING at a 1-1/4 inch iron pipe found at the northwest property corner of the said 164.208 acre tract;

THENCE South 27°12'41" East, over and across the said 164.208 acre tract, a distance of 1,980.71 feet to a mag nail set at the **POINT OF BEGINNING** of the herein described tract of land, said beginning point being on the south property line of the said 164.208 acre tract, same being the north property line of a called 20.00 acre tract conveyed to John M. Lacy, by deed thereof filed for record in Volume 4093, Page 1, D.R.K.C.T., said beginning point also having a grid coordinate of N:6,820,109.08 E:2,624,366.30;

THENCE departing the said property lines and over and across the said 164.208 acre tract the following courses and distances:

North 41°32'29" East, a distance of 166.31 feet to a 5/8 inch iron rod with a cap stamped "SPOONER 5922" set (hereinafter referred to as an iron rod set);

North 87°03'09" East, a distance of 796.63 feet to an iron rod set;

North 89°04'01" East, a distance of 728.80 feet to an iron rod set;

South 89°05'51" East, a distance of 877.77 feet to an iron rod set;

North 87°42'04" East, a distance of 99.58 feet to an iron rod set on the east property line of the said 164.208 acre tract, same being the west property line of a called 37.33 acre tract of land conveyed to Leland R. Cundiff and Marilyn J. Cundiff, by deed as recorded in Volume 876, Page 995 and Volume 876, Page 987, D.R.K.C.T., from which the northeast property corner of the said 164.208 acre tract, same being the northwest property corner of the said 37.33 acre tract bears North 02°31'04" West, a distance of 1,658.27 feet;

THENCE South 02°31'04" East, along the said property lines, a distance of 100.00 feet to an iron rod set from which the southeast property corner of the said 164.208 acre tract, same being the southwest property corner of the said 37.33 acre tract bears South 02°31'04" East, a distance of 23.20 feet;

THENCE departing the said property lines and over and across the said 164.208 acre tract and generally with a fence line the following courses and distances:

South 87°42'04" West, a distance of 102.75 feet to an iron rod set;

North 89°05'51" West, a distance of 878.96 feet to an iron rod set;

South 89°04'01" West, a distance of 725.44 feet to an iron rod set;

South 87°03'09" West, a distance of 752.93 feet to an iron rod set;

South 41°32'29" West, a distance of 26.91 feet to a mag nail set on said south property line, same being the said north property line;

South 87°16'55" West, along the said property lines, 139.63 feet to the **POINT OF BEGINNING**, and containing **5.9183 acres (257,803 square feet)** of land, more or less.

NOTE: Basis of Bearings is the Texas State Plane Coordinate System, North Central Zone (4202) North American Datum (NAD83) (2007) with all distances scaled from N:6,280,412.879 E:2,638,417.218 by a project combined scale factor of 0.99993245856.

NOTE: Plat to accompany this legal description.

I do certify on this 8th day of May, 2013, to Kaufman County Title & Abstract Company, First American Title Insurance Company, and Tarrant Regional Water District, that a survey was made on the ground as per the field notes shown on this survey and is true and correct according to the standards of the Texas Society of Professional Surveyors Standards and Specifications for a Category 2, Condition IV Survey, and accurate as to the boundaries and areas of the subject property and the size, location and type of buildings and improvements, if any, and shows the location of all visible easements and rights-of-way and the rights-of-way, easements and other matters of record as listed in Schedule B of the Commitment for Title issued by First American Title Insurance Company, with an effective date of April 22, 2013, issued May 1, 2013, GF # 1805211-KT50, affecting the subject property.

Except as shown on the survey: (i) there are no visible encroachments upon the subject property by visible improvements on adjacent property, (ii) there are no visible encroachments on adjacent property, streets or alleys by any visible improvements on the subject property, and (iii) there are no visible conflicts or discrepancies.

This survey substantially complies with the current Texas Society of Professional Surveyors Standards and Specifications for a Category 2, Condition IV Survey.



Eric S. Spooner
Registered Professional Land Surveyor
Texas Registration Number 5922

10-30-19
Date



○ = 5/8" IRON ROD SET WITH CAP
 STAMPED "SPOONER 5922" SET
 UNLESS OTHERWISE SHOWN.
 ⊙ = MAG NAIL SET

EXHIBIT "A" PARCEL 6



GRAPHIC SCALE IN FEET
 1" = 200'

P.O.C.

EXHIBIT "A"

1-1/4" IPF ~ @ THE N.W.C.
 OF THE 164.208 ACRES

CALLED: 164.208 ACRES
SANDRA KAYE LACY
 VOL. 2441, PG. 536,
 D.R.K.C.T.

WILLIAM S. CAMPBELL SURVEY
 ABSTRACT NO. 112

PARCEL 6
EXHIBIT "A"
 5.9183 ACRES
 (257,803 S.F.)

COUNTY ROAD NO. 4072
 (VARIABLE WIDTH R.O.W.)

P.O.B.
EXHIBIT "A"
 N:6,820,109.08
 E:2,624,366.30
 (GRID)

CALLED: 20.00 ACRES
JOHN M. LACY
 VOL. 4093, PG. 1
 D.R.K.C.T.

LINE TABLE		
NO.	DIRECTION	DIST.
L1	N41°32'29"E	166.31'
L2	N87°03'09"E	796.63'
L3	N89°04'01"E	728.80'
L9	S89°04'01"W	725.44'
L10	S87°03'09"W	752.93'
L11	S41°32'29"W	26.91'
L12	S87°16'55"W	139.63'

NOTE: LEGAL DESCRIPTION TO ACCOMPANY THIS PLAT.

SPOONER & ASSOCIATES
 REGISTERED PROFESSIONAL LAND SURVEYORS

SPOONER AND ASSOCIATES, INC.
 309 BYERS STREET, SUITE 100
 EULESS, TEXAS 76039
 TEL 817-281-2355
 FAX 817-685-8508

PROJ NO: 09-086-3
 SCALE: 1" = 200'
 DATE: 05/08/2013
 DRAWN BY: C.R.R.
 CHECKED BY: E.S.S.
 REVISED DATE: 10/30/2019

10-30-19

[Signature]

SHEET TITLE **EXHIBIT "A"**
PARCEL 6
SANDRA KAYE LACY

PROJECT CEDAR CREEK
 FINISHED WATER PIPELINE

BASIS OF BEARING IS THE TEXAS STATE PLANE COORDINATE SYSTEM, NORTH CENTRAL ZONE (4202) NORTH AMERICAN DATUM (NAD83)(2007) WITH ALL DISTANCES SCALED FROM N:6,820,412.879, E: 2,638,417.218 BY A PROJECT COMBINED SCALE FACTOR OF 0.99993245856.

PG. 3 OF 5

SEE SHEET 4 OF 5
 MATCH LINE

○ = 1/2 IRON ROD SET WITH CAP STAMPED
 "SPOONER & ASSOCIATES" SET UNLESS
 OTHERWISE SHOWN.

EXHIBIT "A" PARCEL 6

APPROX. LOCATION OF
 SURVEY LINE

PROPERTY
 LINE

WILLIAM S. CAMPBELL SURVEY
 ABSTRACT NO. 112

CALLED: 37.33 ACRES
**LELAND R. CUNDIFF &
 MARILYN J. CUNDIFF**
 VOL. 876, PG. 995,
 VOL. 876, PG. 987,
 D.R.K.C.T.

CALLLED: 164.208 ACRES
SANDRA KAYE LACY
 VOL. 2441, PG. 536,
 D.R.K.C.T.

**PARCEL 6
 EXHIBIT "A"**
 5.9183 ACRES
 (257,803 S.F.)

N02°31'04"W - 1,658.27'
 TO THE N.E.C. OF THE
 164.208 ACRE TRACT

SEE SHEET 3 OF 5

MATCH LINE

L3

L4

L5

L9

L8

L7

97

COUNTY ROAD NO. 4072
 (VARIABLE WIDTH R.O.W.)

PROPERTY
 LINE

APPARENT
 2 ACRE TRACT
 NO RECORDS
 FOUND

S02°31'04"E
 23.03'

LINE TABLE		
NO.	DIRECTION	DIST.
L3	N89°04'01"E	728.80'
L4	S89°05'51"E	877.77'
L5	N87°42'04"E	99.58'
L6	S02°31'04"E	100.00'
L7	S87°42'04"W	102.75'
L8	N89°05'51"W	878.96'
L9	S89°04'01"W	725.44'

REMAINDER OF A
 CALLED 101.266 ACRES
**JERRY G. BREWER SR.
 AND PATRICIA A. BREWER**
 VOL. 2161, PG. 180,
 D.R.H.C.T.

NOTE: LEGAL DESCRIPTION TO ACCOMPANY THIS PLAT.



SPOONER AND ASSOCIATES, INC.
 309 BYERS STREET, SUITE 100
 EULESS, TEXAS 76039
 TEL 817-281-2355
 FAX 817-685-8508

10-30-19

SHEET TITLE

**EXHIBIT "A"
 PARCEL 6
 SANDRA KAYE LACY**

PROJECT

CEDAR CREEK
 FINISHED WATER PIPELINE

PROJ NO: 09-086-3
 SCALE: 1" = 200'
 DATE: 05/08/2013
 DRAWN BY: C.R.R.
 CHECKED BY: E.S.S.
 REVISED DATE: 10/30/2019



BASIS OF BEARING IS THE TEXAS STATE PLANE COORDINATE
 SYSTEM, NORTH CENTRAL ZONE (4202) NORTH AMERICAN DATUM
 (NAD83)(2007) WITH ALL DISTANCES SCALED FROM N:8,820,412.879, E:
 2,638,417.218 BY A PROJECT COMBINED SCALE FACTOR OF 0.99993245856.

PG. 4 OF 5

EXHIBIT "A"
Property Description

BEING a 9.693 acre (422,237 square feet) tract of land located in the Thomas Berry Survey, Abstract No. 71, Henderson County, Texas, said 9.693 acre tract of land also being a portion of a called 135.75 acre tract of land conveyed to **HENRY SHERMAN HEATHER** and **FAIRY ELIZABETH HEATHER WARREN**, by deed as recorded in Volume 1567, Page 803, Deed Records, Henderson County, Texas (D.R.H.C.T.), and being more particularly described by metes and bounds as follows:

COMMENCING at a 1/2 inch iron rod found at the most northerly northwest property corner of the said 135.75 acre tract, same being the most southerly southwest property corner of a called 250.00 acre tract of land conveyed to Darrell J. Roberts and Sherry A. Roberts, by deed as recorded in Volume 2209, Page 115, Deed Records, Kaufman County, Texas (D.R.K.C.T.);

THENCE North 89°44'20" East, along the north property line of the said 135.75 acre tract and along a south property line of the said 250.00 acre tract, a distance of 978.55 feet to a 1/2 inch iron rod with a cap stamped "SPOONER & ASSOCIATES" set (hereinafter referred as an iron rod set) at the **POINT OF BEGINNING** of the herein described tract of land (said beginning point having a grid coordinate of N:6,820,209.759 E:2,630,363.783);

THENCE North 89°44'20" East, continuing along said property lines and generally with a fence line, a distance of 228.04 feet to a 5/8 inch iron rod found on the north property line of the said 135.75 acre tract, same being the southwest property corner of a called 47.48 acre tract of land conveyed to James A. Fosner and Donna M. Fosner, by deed as recorded in Volume 2460, Page 79, D.R.K.C.T.;

THENCE North 89°44'34" East, along the north property line of the said 135.75 acre tract and along the south property line of the said 47.48 acre tract, and generally with a fence, at a distance of 4,023.62 feet passing a 3/4 inch iron rod found on the said property lines, continuing for a total distance of 4,045.12 feet to an iron rod set on the east property line of the said 135.75 acre tract, same being the west property line of a called 100 acre tract of land described as "Second Tract" conveyed to Fred G. Poteet, by deed as recorded in Volume 790, Page 25, D.R.K.C.T.;

THENCE South 01°16'56" East, along the said east property line of the 135.75 acre tract and along the said west property line of the said 100 acre tract, a distance of 100.02 feet to an iron rod set;

THENCE departing the said property lines, over and across the said 135.75 acre tract the following courses and distances:

South 89°44'34" West, a distance of 4,171.59 feet to an iron rod set;

North 46°12'36" West, a distance of 143.81 feet to the **POINT OF BEGINNING**, and containing **9.693 acres (422,237 square feet)** of land, more or less.

NOTE: Basis of Bearings is the Texas State Plane Coordinate System, North Central Zone (4202) North American Datum (NAD83)(2007) with all distances scaled from N:6,280,412.879 E:2,638,417.218 by a project combined scale factor of 0.99993245856.

NOTE: Plat to accompany this legal description

I do certify on this 3rd day of January, 2017, to Tarrant Regional Water District, that a survey was made on the ground as per the field notes shown on this survey and is true and correct according to the standards of the Texas Society of Professional Surveyors Standards and Specifications for a Category 2, Condition IV Survey, and accurate as to the boundaries and areas of the subject property and the size, location and type of buildings and improvements, if any, and shows the location of all visible easements and rights-of-way and the rights-of-way, easements and other matters of record as listed in Schedule B of the Commitment for Title issued by Fidelity National Title Insurance Company, with an effective date of November 30, 2015, issued December 9, 2015, GF # 13-076-DD, affecting the subject property.

Except as shown on the survey: (i) there are no visible encroachments upon the subject property by visible improvements on adjacent property, (ii) there are no visible encroachments on adjacent property, streets or alleys by any visible improvements on the subject property, and (iii) there are no visible conflicts or discrepancies.

This survey substantially complies with the current Texas Society of Professional Surveyors Standards and Specifications for a Category 2, Condition IV Survey.

Eric S. Spooner, RPLS
Registered Professional Land Surveyor
Texas Registration Number 5922



EXHIBIT "A" PARCEL 10

○ = 1/2 IRON ROD SET WITH CAP STAMPED
"SPOONER & ASSOCIATES" SET UNLESS
OTHERWISE SHOWN.

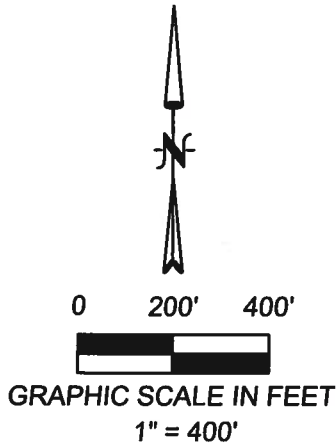

CALLED: 250.00 ACRES
DARRELL J. ROBERTS
SHERRY A. ROBERTS
VOL. 2209, PG. 115,
D.R.K.C.T.

THOMAS BERRY SURVEY
ABSTRACT NO. 25

(VARIABLE WIDTH R.O.W.)
COUNTY ROAD NO. 4072

P.O.B.
EXHIBIT "A"

N:6,820,209.759
E:2,630,363.783
(GRID)

CALLER: 47.48 ACRES
**JAMES A. FOSNER &
DONNA FOSNER**
VOL. 2460, PG. 79,
D.R.K.C.T.

APPROX. LOCATION
OF SURVEY LINE

N89°44'20"E ~ 978.55'

P.O.C.
EXHIBIT "A"
1/2" IRF

PROPERTY
LINE

THOMAS BERRY SURVEY
ABSTRACT NO. 71

N89°44'34"E ~ 4,045.12'

S89°44'34"W ~ 4,171.59'

PARCEL 10
EXHIBIT "A"
9.693 ACRES
(422,237 S.F.)

CALLER: 135.75 ACRES
**HENRY SHERMAN HEATHER &
FAIRY ELIZABETH HEATHER WARREN**
VOL. 1567, PG. 803,
D.R.H.C.T.

APPROX. LOCATION OF ESMT. &
R.O.W. TO T.P. & L. CO.
VOL. 527, PG. 34,
D.R.H.C.T.

PROPERTY
LINE

SEE SHEET 4 OF 5
MATCHLINE

LINE TABLE		
NO.	DIRECTION	DIST.
L1	N89°44'20"E	228.04'
L2	S01°16'56"E	100.02'
L3	N46°12'36"W	143.81'

SURVEYED ON THE GROUND JUNE-2013

NOTE: LEGAL DESCRIPTION TO ACCOMPANY THIS PLAT.



SPOONER AND ASSOCIATES, INC.
309 BYERS STREET, SUITE 100
EULESS, TEXAS 76039
TEL 817-685-8448



[Handwritten Signature]

SHEET TITLE

EXHIBIT "A"

PARCEL 10

**HENRY SHERMAN HEATHER &
FAIRY ELIZABETH HEATHER WARREN**

PROJECT

CEDAR CREEK
FINISHED WATER PIPELINE

BASIS OF BEARING IS THE TEXAS STATE PLANE COORDINATE
SYSTEM, NORTH CENTRAL ZONE (4202) NORTH AMERICAN DATUM
(NAD83)(2007) WITH ALL DISTANCES SCALED FROM N:6,820,412.879, E:
2,638,417.218 BY A PROJECT COMBINED SCALE FACTOR OF 0.99993245856.

PG. 3 OF 5

PROJ NO: 09-086-3
SCALE: 1" = 400'
DATE: 06/10/2013
DRAWN BY: C.R.R.
CHECKED BY: E.S.S.
REVISED DATE: 01/19/2018

EXHIBIT "A" PARCEL 10

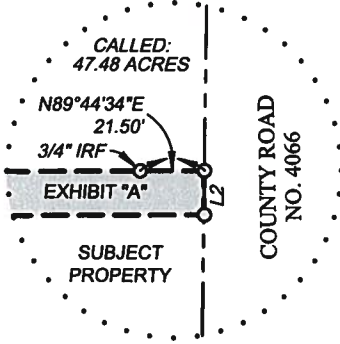

INSET
(NOT TO SCALE)

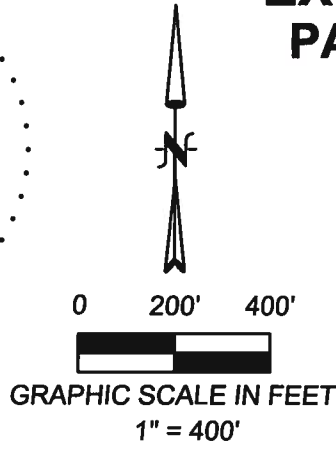

LINE TABLE		
NO.	DIRECTION	DIST.
L1	N89°44'20"E	228.04'
L2	S01°16'56"E	100.02'
L3	N46°12'36"W	143.81'

THOMAS BERRY SURVEY
ABSTRACT NO. 25

(VARIABLE WIDTH R.O.W.)
COUNTY ROAD NO. 4072

CALLLED: 47.48 ACRES
**JAMES A. FOSNER &
DONNA FOSNER**
VOL. 2460, PG. 79,
D.R.K.C.T.

SEE INSET

CALLLED: 100 ACRES
FRED G. POTEET
"SECOND TRACT" IN
VOL. 790, PG. 25,
D.R.K.C.T.

PROPERTY LINE

APPROX. LOCATION OF SURVEY LINE

N89°44'34"E ~ 4,045.12'

S89°44'34"W ~ 4,171.59'

PARCEL 10
EXHIBIT "A"
9.693 ACRES
(422,237 S.F.)

CALLLED: 135.75 ACRES
**HENRY SHERMAN HEATHER &
FAIRY ELIZABETH HEATHER WARREN**
VOL. 1567, PG. 803,
D.R.H.C.T.

THOMAS BERRY SURVEY
ABSTRACT NO. 71

SEE SHEET 3 OF 5

COUNTY ROAD NO. 4066
(VARIABLE WIDTH R.O.W.)

○ = 1/2 IRON ROD SET WITH CAP STAMPED
"SPOONER & ASSOCIATES" SET UNLESS
OTHERWISE SHOWN.

PROPERTY LINE

SURVEYED ON THE GROUND JUNE-2013

NOTE: LEGAL DESCRIPTION TO ACCOMPANY THIS PLAT.

SPOONER & ASSOCIATES
REGISTERED PROFESSIONAL LAND SURVEYORS
SPOONER AND ASSOCIATES, INC.
309 BYERS STREET, SUITE 100
EULESS, TEXAS 76039
TEL 817-685-8448



SHEET TITLE
EXHIBIT "A"
PARCEL 10
**HENRY SHERMAN HEATHER &
FAIRY ELIZABETH HEATHER WARREN**

PROJECT
CEDAR CREEK
FINISHED WATER PIPELINE

PROJ NO: 09-086-3
SCALE: 1" = 400'
DATE: 06/10/2013
DRAWN BY: C.R.R.
CHECKED BY: E.S.S.
REVISED DATE: 01/19/2018

BASIS OF BEARING IS THE TEXAS STATE PLANE COORDINATE SYSTEM, NORTH CENTRAL ZONE (4202) NORTH AMERICAN DATUM (NAD83)(2007) WITH ALL DISTANCES SCALED FROM N:6,820,412.879, E: 2,638,417.218 BY A PROJECT COMBINED SCALE FACTOR OF 0.99993245856.

PG. 4 OF 5

EXHIBIT “A”
Property Description

BEING 3.8638 acre (168,308 square feet) tract of land situated in the John Baker Survey, Abstract No. 17, Kaufman County, Texas, said 3.8638 acre tract of land also being a portion of a called 9.536 acre tract of land and a called 31.69 acre tract of land conveyed to **MICHAEL GLENN RANKIN** and **SHARRON R. RANKIN** described as “Exhibits A-1 and A-2” by deed as recorded in Volume 736, Page 332, Deed Records, Kaufman County, Texas, (D.R.K.C.T.), said 3.8638 acre tract of land being a variable width Access Easement and Right-of-Way and being more particularly described by metes and bounds as follows:

BEGINNING at a 1/2 inch iron rod with a cap stamped “SPOONER & ASSOCIATES” set (hereinafter referred to as an iron rod set) on the north right-of-way line of County Road No. 4042 from which the intersection of the said north right-of-way line of County Road No. 4042 and the west property line of the said Rankin tract bears North 54° 22’ 51” West, a distance of 18.69 feet, said beginning point also having a grid coordinate of N: 6,825,341.63 and E: 2,668,234.10;

THENCE departing the said right-of-way line, over and across the said Rankin tract, the following courses and distances:

North 01°01’23” West, along a line 15 feet east of and parallel with the west property line of the said Rankin tract, a distance of 2,532.50 feet to an iron rod set;

North 45° 00’ 00” East, a distance of 606.08 feet to an iron rod set at the north property line of the said Rankin tract, same being the south property line of a called 125.76 acre tract of land conveyed to Tarrant County Water Control and Improvement District No. 1 by deed as recorded in Volume 465, Page 316, D.R.K.C.T., said iron rod being North 89° 21’ 23” East, a distance of 344.43 feet;

THENCE North 89°21’23” East, along said the property lines, a distance of 93.54 feet to an iron rod set;

THENCE departing the said property lines, over and across the said Rankin tract, the following courses and distances:

South 54° 49’ 45” West, a distance of 90.19 feet to an iron rod set;

South 45° 00’ 00” West, a distance of 399.38 feet to an iron rod set;

South 21° 55’ 09” West, a distance of 301.80 feet to an iron rod set;

South 01°01’23” East, a distance of 2,384.05 feet to an iron rod set on the said north right-of-way line of County Road No. 4042;

THENCE North 54° 22’ 51” West, along the right-of-way line, a distance of 62.31 feet to the **POINT OF BEGINNING**, and containing **3.8638 acres (168,308 square feet)** of land, more or less.

NOTE: Basis of Bearings is the Texas State Plane Coordinate System, North Central Zone (4202) North American Datum (NAD83)(2007) with all distances scaled from N:6,280,412.879 E:2,638,417.218 by a project combined scale factor of 0.99993245856.

NOTE: Plat to accompany this legal description

I do certify on this 15th day, November, 2016, to Tarrant Regional Water District, First American Title Guaranty Company, Kaufman County Title & Abstract Company, that a survey was made on the ground as per the field notes shown on this survey and is true and correct according to the standards of the Texas Society of Professional Surveyors Standards and Specifications for a Category 2, Condition IV Survey, and accurate as to the boundaries and areas of the subject property and the size, location and type of buildings and improvements, if any, and shows the location of all visible easements and rights-of-way and the rights-of-way, easements and other matters of record as listed in Schedule B of the Commitment for Title issued by First American Title Insurance Company, having a commitment number of KCT-2200013, an effective date of October 20, 2016 and an issued date of November 03, 2016, affecting the subject property.

Except as shown on the survey: (i) there are no visible encroachments upon the subject property by visible improvements on adjacent property, (ii) there are no visible encroachments on adjacent property, streets or alleys by any visible improvements on the subject property, and (iii) there are no visible conflicts or discrepancies.

This survey substantially complies with the current Texas Society of Professional Surveyors Standards and Specifications for a Category 2, Condition IV Survey.

 11-22-16
Eric S. Spooner, RPLS
Registered Professional Land Surveyor
Texas Registration Number 5922
TBPLS Firm No. 10054900



EXHIBIT "A" PARCEL 37 Access Road

N89°21'23"E
344.43'

CALLED: 24.381 ACRES
MATHEW EDWARDS &
JENNIFER EDWARDS
VOL. 4000, PG. 112,
D.R.K.C.T.

CALLED:
125.76 ACRES

TARRANT COUNTY WATER CONTROL
& IMPROVEMENT DISTRICT NO. 1
VOL. 465, PG. 316, D.R.K.C.T.

JOHN BAKER SURVEY
ABSTRACT NO. 17

CALLER: 31.69 ACRES
MICHAEL GLENN RANKIN
& SHARRON R. RANKIN
"EXHIBIT A-1"
VOL. 736, PG. 332,
D.R.K.C.T.

CALLER: 49.893 ACRES
CHARLES G. NEMEC, III
& KATHERINE A. NEMEC,
TRUSTEES OF THE
NEMEC LIVING TRUST
VOL. 3914, PG. 17,
D.R.K.C.T.

CALLER: 45.813 AC.
STEPHEN C. SPARKS
VIVIAN G. FOGUE
VOL. 1789, PG. 188
D.R.K.C.T.

EXHIBIT "B" ~
VARIABLE WIDTH ACCESS
EASEMENT & RIGHT-OF-WAY
3.8638 ACRES (168,308 S.F.)
(SHADED)

EXHIBIT "A"
ELECTRIC EASEMENT
BY SEPARATE INSTRUMENT

CALLER: 9.536 ACRES
MICHAEL GLENN RANKIN
& SHARRON R. RANKIN
"EXHIBIT A-2"
VOL. 736, PG. 332,
D.R.K.C.T.

CALLER: 30.084 ACRES
ROGER D. PIERCE &
DEBRA D. PIERCE
VOL. 2381, PG. 223,
D.R.K.C.T.

CALLER: 13.677 ACRES
MICHAEL GLENN RANKIN
& SHARRON R. RANKIN
VOL. 956, PG. 818,
D.R.K.C.T.

LINE TABLE		
NO.	DIRECTION	DIST.
L1	N01°01'23"W	2,532.50'
L2	N45°00'00"E	608.08'
L3	N89°21'23"E	93.54'
L4	S54°49'45"W	90.19'
L5	S45°00'00"W	399.38'
L6	S21°55'09"W	301.80'
L7	S01°01'23"E	2,384.05'
L8	N54°22'51"W	62.31'

○ = 1/2 IRON ROD SET WITH CAP STAMPED
"SPOONER & ASSOCIATES" SET UNLESS
OTHERWISE SHOWN.

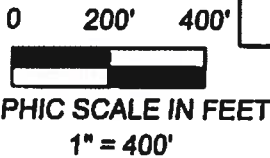

P.O.B.
EXHIBIT "A"
N: 6,825,341.63
E: 2,668,234.10
(GRID)

COUNTY ROAD

SEE INSET

NO. 4042

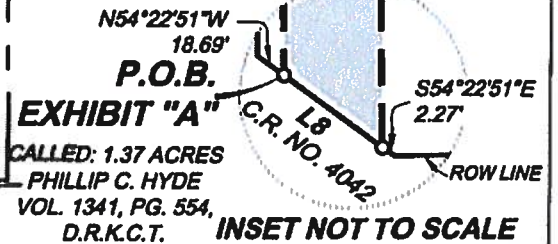

NOTE: LEGAL DESCRIPTION TO ACCOMPANY THIS PLAT.



SPOONER AND ASSOCIATES, INC.
309 BYERS STREET, SUITE 100
EULESS, TEXAS 76039
TEL 817-885-8448

PROJ NO: 09-086-3
SCALE: 1" = 400'
DATE: 05/17/2013
DRAWN BY: R.W.B.
CHECKED BY: E.S.S.
REVISED DATE: 10/18/2016



TBPLS NO. 1007800

SHEET TITLE

EXHIBIT "A"
PARCEL 37 - Access Road
MICHAEL GLENN RANKIN &
SHARRON R. RANKIN

PROJECT

CEDAR CREEK
FINISHED WATER PIPELINE

BASIS OF BEARING IS THE TEXAS STATE PLANE COORDINATE
SYSTEM, NORTH CENTRAL ZONE (4202) NORTH AMERICAN DATUM
(NAD83)(2007) WITH ALL DISTANCES SCALED FROM N 6,820,412.879, E
2,638,417.218 BY A PROJECT COMBINED SCALE FACTOR OF 0.99993245859.

PG. 3 OF 4

EXHIBIT "A"
Property Description

BEING 1.0784 acre (46,976 square feet) tract of land situated in the John Baker Survey, Abstract No. 17, Kaufman County, Texas, said 1.0784 acre tract of land also being a portion of a called 9.536 acre tract of land and a called 31.69 acre tract of land conveyed to **MICHAEL GLENN RANKIN** and **SHARRON R. RANKIN** described as "Exhibits A-1 and A-2" by deed as recorded in Volume 736, Page 332, Deed Records, Kaufman County, Texas, (D.R.K.C.T.), said 1.0784 acre tract of land being a 15 feet wide Electrical Easement and Right-of-Way and being more particularly described by metes and bounds as follows:

BEGINNING at a 1/2 inch iron rod with a cap stamped "SPOONER & ASSOCIATES" set (hereinafter referred to as an iron rod set) on the west property line of the said Rankin tract, said beginning point being on the north right-of-way line of County Road No. 4042, said beginning point also having a grid coordinate of N: 6,825,352.52 and E: 2,668,218.90;

THENCE North 01°01'23" West, along the said property line, at a distance of 80.45 feet passing the southeast property corner of a called 49.893 acre tract of land conveyed to Charles G. Nemec, III and Katherine A. Nemec, Trustees of the Nemec Living Trust, by deed as recorded in Volume 3914, Page 17, D.R.K.C.T., continuing along the said west property line of Rankin tract and along the east property line of the said Nemec tract, in all a total distance of 2,527.72 feet to an iron rod set from which the most westerly northwest property corner of the said Rankin tract, same being the northeast property corner of the said Nemec tract bears North 01° 01' 23" West, a distance of 156.05 feet;

THENCE North 45° 00' 00" East, departing the said property lines, over and across the said Rankin tract, a distance of 597.11 feet to an iron rod set at the north property line of the said Rankin tract, same being the south property line of a called 125.76 acre tract of land conveyed to Tarrant County Water Control and Improvement District No. 1 by deed as recorded in Volume 465, Page 316, D.R.K.C.T., said iron rod being North 89° 21' 23" East, a distance of 322.98 feet from the most northerly northwest property corner of the said Rankin tract;

THENCE North 89°21'23" East, along said the property lines, a distance of 21.46 feet to an iron rod set;

THENCE departing the said property lines, over and across the said Rankin tract, the following courses and distances:

South 45° 00' 00" West, a distance of 606.08 feet to an iron rod set;

South 01°01'23" East, a distance of 2,532.50 feet to an iron rod set on the north right-of-way line of said County Road No. 4042;

THENCE North 54° 22' 51" West, along the right-of-way line, a distance of 18.69 feet to the **POINT OF BEGINNING**, and containing **1.0784 acres (46,976 square feet)** of land, more or less.

NOTE: Basis of Bearings is the Texas State Plane Coordinate System, North Central Zone (4202) North American Datum (NAD83)(2007) with all distances scaled from N:6,280,412.879 E:2,638,417.218 by a project combined scale factor of 0.99993245856.

NOTE: Plat to accompany this legal description

I do certify on this 15th day, November, 2016, to Tarrant Regional Water District, First American Title Guaranty Company, Kaufman County Title & Abstract Company, that a survey was made on the ground as per the field notes shown on this survey and is true and correct according to the standards of the Texas Society of Professional Surveyors Standards and Specifications for a Category 2, Condition IV Survey, and accurate as to the boundaries and areas of the subject property and the size, location and type of buildings and improvements, if any, and shows the location of all visible easements and rights-of-way and the rights-of-way, easements and other matters of record as listed in Schedule B of the Commitment for Title issued by First American Title Insurance Company, having a commitment number of KCT-2200013, an effective date of October 20, 2016 and an issued date of November 03, 2016, affecting the subject property.

Except as shown on the survey: (i) there are no visible encroachments upon the subject property by visible improvements on adjacent property, (ii) there are no visible encroachments on adjacent property, streets or alleys by any visible improvements on the subject property, and (iii) there are no visible conflicts or discrepancies.

This survey substantially complies with the current Texas Society of Professional Surveyors Standards and Specifications for a Category 2, Condition IV Survey.



11-22-16
Eric S. Spooner, RPLS
Registered Professional Land Surveyor
Texas Registration Number 5922
TBPLS Firm No. 10054900



EXHIBIT "A" PARCEL 37 Electric

CALLLED: 24.381 ACRES
MATH EW EDWARDS &
JENNIFER EDWARDS
VOL. 4000, PG. 112,
D.R.K.C.T.

CALLLED: 125.76 ACRES
TARRANT COUNTY WATER CONTROL
& IMPROVEMENT DISTRICT NO. 1
VOL. 465, PG. 316, D.R.K.C.T.

CALLLED: 49.893 ACRES
CHARLES G. NEMEC, III
& KATHERINE A. NEMEC,
TRUSTEES OF THE
NEMEC LIVING TRUST
VOL. 3914, PG. 17,
D.R.K.C.T.

CALLLED: 31.69 ACRES
MICHAEL GLENN RANKIN
& SHARRON R. RANKIN
"EXHIBIT A-1"
VOL. 736, PG. 332,
D.R.K.C.T.

JOHN BAKER SURVEY
ABSTRACT NO. 17

CALLLED: 45.813 AC.
STEPHEN C. SPARKS
VIVIAN G. FOGUE
VOL. 1789, PG. 188
D.R.K.C.T.

CALLLED: 30.084 ACRES
ROGER D. PIERCE &
DEBRA D. PIERCE
VOL. 2381, PG. 223,
D.R.K.C.T.

CALLLED: 13.677 ACRES
MICHAEL GLENN RANKIN
& SHARRON R. RANKIN
VOL. 856, PG. 818,
D.R.K.C.T.

LINE TABLE

NO.	DIRECTION	DIST.
L1	N01°01'23"W	2,527.72'
L2	N45°00'00"E	597.11'
L3	N89°21'23"E	21.46'
L4	S45°00'00"W	608.08'
L5	S01°01'23"E	2,532.50'
L6	N54°22'51"W	18.89'

○ = 1/2 IRON ROD SET WITH CAP STAMPED
"SPOONER & ASSOCIATES" SET UNLESS
OTHERWISE SHOWN.

CALLLED: 1.37 ACRES
PHILLIP C. HYDE
VOL. 1341, PG. 554,
D.R.K.C.T.

EXHIBIT "A"
ACCESS ROAD
80.45°
P.O.B.
EXHIBIT "A"
ROW LINE
S54°22'51"E
64.58'
C.R. NO. 4042

EXH. "A"
INSET
N.T.S.
EXHIBIT "A" ~
15 FEET WIDE
ELECTRICAL EASEMENT
AND RIGHT-OF-WAY
1.0784 ACRES (46,976 S.F.)
(SHADED)

EXHIBIT "A"
ACCESS ROAD
BY SEPARATE INSTRUMENT
CALLLED: 9.536 ACRES
MICHAEL GLENN RANKIN
& SHARRON R. RANKIN
"EXHIBIT A-2"
VOL. 736, PG. 332,
D.R.K.C.T.

P.O.B.
EXHIBIT "A"
N:8,825,352.52
E:2,668,218.90
(GRID)

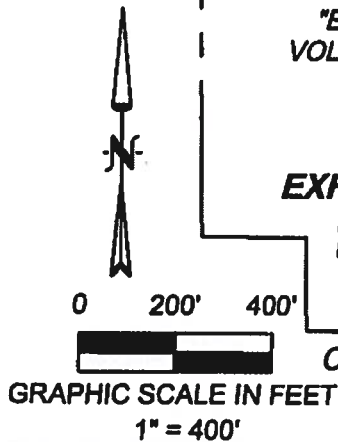

COUNTY ROAD

SEE INSET NO. 4042

NOTE: LEGAL DESCRIPTION TO ACCOMPANY THIS PLAT.

INSET NOT TO SCALE



SPOONER AND ASSOCIATES, INC.
309 BYERS STREET, SUITE 100
EULESS, TEXAS 76039
TEL 817-685-8448

PROJ NO: 09-086-3
SCALE: 1" = 400'
DATE: 05/17/2013
DRAWN BY: R.W.B.
CHECKED BY: E.S.S.
REVISED DATE: 10/18/2018



TBPLS NO. 10-54500

SHEET TITLE

EXHIBIT "A"
PARCEL 37 - Electric
MICHAEL GLENN RANKIN
& SHARRON R. RANKIN

PROJECT

CEDAR CREEK
FINISHED WATER PIPELINE

BASIS OF BEARING IS THE TEXAS STATE PLANE COORDINATE
SYSTEM NORTH CENTRAL ZONE (4202) NORTH AMERICAN DATUM
(NAD83)(2007) WITH ALL DISTANCES SCALED FROM N 8,820,412.879, E
2,638,417,218 BY A PROJECT COMBINED SCALE FACTOR OF 0.99993245856

PG. 3 OF 4

In addition, the General Manager or his designee are granted authority to execute all documents necessary to complete these transactions and to pay all reasonable and necessary closing and related costs incurred with these acquisitions. Director Hill seconded the motion and the vote in favor was unanimous.

11.

With the recommendation of management and General Counsel, Director King moved to approve the tentative settlement of claims in the Integrated Pipeline Project – Baxter (516) Lawsuit for payment of the sum of \$275,000. Funding for this item is included in the Bond Fund. Director Hill seconded the motion and the vote in favor was unanimous. Director Hill requested that the minutes reflect that he voted affirmatively with hesitation.

12.

With the recommendation of management and General Counsel, Director Hill moved to adopt a resolution formally transferring certain Trinity River Vision Authority (TRVA) activities to TRWD. Director King seconded the motion and the vote in favor was unanimous.

13.

Future Agenda

Director Hill made a motion for the following future agenda items:

- Review and Update conflict of Interest Policy
- Develop process of annual review for General Manager
- Review governance documents for the Water District and Consider Creation of HR Governance Committee

Director King seconded the motion.

14.

The next board meeting was scheduled for December 17, 2019 at 9:00 A.M.

15.

There being no further business before the Board of Directors, the meeting was adjourned.



President

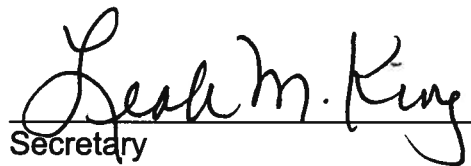

Secretary