



# **MUDDY WATERS**

## **THE ORIGINS OF COVID-19**

By The Muddy Waters Group

**Reference Source Document**

The end of the  
beginning...

**January 27, 2023**

## Table of Contents

Muddy Waters Group Investigation Executive Summary .....	5
Introduction.....	6
1. Epidemiology Favors Late October-Early November Emergence .....	6
2. Precedent of Zoonotic Spillovers & Likelihood of an Animal Origin.....	8
3. Plausibility of a Research-related Incident & Laboratory-acquired Infections.....	10
4. Summation of Events Leading to the Pandemic .....	14
a. Table 1. Pros & Cons of Zoonotic Origin Hypothesis .....	18
b. Table 2. Pros & Cons of Research-related Origin Hypothesis.....	18
Introduction.....	6
Methodology .....	21
Study Limitations.....	22
Part I.....	23
Chapter 1: What is SARS-CoV-2 and Where is it From?.....	23
Introduction.....	23
1. Coronaviruses .....	23
2. SARS-CoV-2 .....	25
a. Overview.....	25
b. SARS-CoV-2's Spike Protein.....	27
3. Where is SARS-CoV-2 From?.....	35
Chapter 2: Chronology of the Early SARS-CoV-2 Outbreak.....	40
Introduction.....	40
1. Emergence: October-November 2019 .....	40
a. Epidemiological & Phylogenetic Modeling Suggests Early-October to Mid-November 2019 Emergence.....	41
b. Wuhan ILI Surveillance Sees Uptick in Cases in the Last Week of November 2019 .....	42
c. Spike in Lab Test Negative ILI in Wuhan in mid-November 2019.....	43
d. Abnormal Increase of ILI: Possible Early Indicator of COVID Spread .....	45
e. U.S. Consulate Reports “Vicious” Flu Season.....	45
f. Wuhan Hosts Military World Games, Athletes Report Illness .....	46
g. Hospital Traffic & Online Searches for COVID-19 Symptoms Spike .....	46
h. China Launches COVID-19 Vaccine Program .....	47
i. Rumors of New Virus Spread in Wuhan, Doctors See Influx of Patients .....	47
j. WIV Researchers Hospitalized with COVID-19 Symptoms .....	47

k. Wuhan University Biostatistics Professor Identifies Cases with Symptom onset in mid-November 2019.....	48
l. Unpublished PRC Government Data Lists COVID-19 Cases in Mid-November, including Earliest Known Potential Index Case.....	48
m. English Teacher Develops Pneumonia, Later Confirmed to be COVID-19 .....	49
n. Serological Studies on Pre-Pandemic Samples Indicate SARS-CoV-2 Circulating Internationally in November and December 2019 .....	49
o. Additional Sewage Water and Clinical Testing Identifies Earlier SARS-CoV-2 Incidence in Italy, Brazil and France.....	50
2. Outbreak Underway: December 2019.....	51
a. Wuhan Closes Schools Because of Outbreak .....	51
b. Chinese Social Media Begins to See an Increase in Requests for Help for Medical Treatments in Wuhan.....	51
c. Prefecture in Western Hubei Province Orders Live Animal Farms Shutdown.....	52
Chapter 3: Early COVID-19 Epidemiology, Anomalies & Shortcomings in China’s Response .....	55
Introduction.....	55
1. Early Identification and Outbreak Epidemiology .....	55
2. Anomalies and Shortcomings .....	58
a. Overly Narrow Case Definitions During Early Outbreak Leads to Under Counting of Early COVID-19 cases.....	58
b. Delayed Release of SARS-CoV-2 Genomic Sequence .....	61
c. Delayed Admission of Human-to-Human Transmission.....	62
d. Destruction of Early COVID-19 Viral Samples and Censorship of Information Related to COVID-19 Outbreak.....	64
e. Failure to Recognize Role of Asymptomatic and Mildly Symptomatic Transmission.....	67
f. Inaccuracy or Inconsistency of Date of First Acknowledged Confirmed Case of COVID-19 ...	67
Chapter 4 : Precedent: Zoonotic Spillovers .....	70
Introduction.....	70
1. 2002-2004 SARS Epidemic .....	72
a. Outbreak and Response by PRC .....	72
b. Investigating the Origins of SARS.....	75
2. Post-SARS Reforms in China’s Public Health System and Infectious Disease Surveillance.....	79
a. Public Health and Infectious Disease Surveillance Reforms.....	79
b. Animal Surveillance and Veterinary Infectious Disease Control Reforms.....	82
3. China’s Success Identifying and Controlling Infectious Disease Outbreaks Post-SARS.....	84
a. 2013-2017 High Pathogenicity Avian Influenza (HPAI) H7N9.....	84

b.	2016 & 2019 Swine Acute Diarrhoea Syndrome (SADS) Outbreak .....	85
c.	2018-2021 Langya Henipavirus Cases .....	86
Chapter 5:	Investigations into the Zoonotic Origins of SARS-CoV-2.....	87
Introduction.....		87
1.	Early Investigations into the Huanan Seafood Market .....	87
a.	Association of Early Known COVID-19 Cases with the Huanan Seafood Market.....	87
b.	Environmental Sampling at the Huanan Market.....	88
c.	Animal Sampling at the Huanan Seafood Market.....	91
d.	Live Animal Sales at the Huanan Seafood Market in November-December 2019.....	92
3.	The Role of Huanan Seafood Market in the SARS-CoV-2 Outbreak.....	96
a.	Early Variants and Evidence the Huanan Market was an Early Super Spreading Event.....	96
b.	Evidence Huanan Seafood Market and Related Supply Chain were the “Epicenter” of the COVID-19 Outbreak.....	97
c.	Sequencing of Huanan Seafood Market Environmental and Animal Samples.....	102
4.	Retrospective Searches for Evidence of Earliest Human Cases of SARS-CoV-2 .....	102
5.	Animal Studies Searching for the Origins of SARS-CoV-2 .....	104
a.	Animal Studies Conducted by PRC Public Health and Animal Health Officials.....	104
b.	SARS-CoV-2 Infections in Animals.....	106
6.	Analysis of Mink, Raccoon Dogs, and Foxes as Candidate Intermediate Hosts for SARS-CoV-2 Outbreaks .....	108
a.	Natural Infections of SARS-CoV-2 in Farmed Mink .....	108
b.	Animal and Fur Farming in the PRC .....	110
Chapter 6:	Evidence of a Natural Zoonotic Origin for SARS-CoV-2 & Outstanding Questions.....	113
Introduction.....		113
1.	Hypothetical Zoonotic Spillover of SARS-CoV-2 .....	113
a.	Transmission from Intermediate Host to Human Hypothesis.....	113
b.	Direct Bat to Human Transmission Hypothesis.....	116
2.	Outstanding Questions in the Zoonotic Origins Hypothesis.....	118
a.	Where is SARS-CoV-2’s Viral Reservoir?.....	119
b.	What was the role of the Huanan Seafood Market?.....	119
c.	Is evidence that China began a COVID-19 vaccine development program no later than mid-November 2019 consistent with a zoonotic origin?.....	121
Part II.		123
Overview.....		123
Chapter 7:	Precedent: Research-related Incidents & Laboratory-acquired Infections.....	123

Introduction.....	123
1. Overview of High-Containment Laboratories and Biological Safety Standards .....	125
a. History of High-Containment Laboratories .....	125
b. Primary and Secondary Biosafety Barriers .....	125
3. Overview of Biosafety Levels for High-Containment Laboratories .....	128
a. Biosafety Level 1 (BSL-1).....	128
b. BSL-2.....	128
c. BSL-3 and ABSL-3: .....	129
d. BSL-4.....	130
4. Challenges Associated with Proliferation of High-Containment Laboratories in Middle Income and Developing Countries.....	131
2. Precedent of Outbreaks Likely Caused by Lab Accidents.....	134
a. Near-Misses, Laboratory Accidents Not Resulting in Infections .....	136
b. Laboratory Accidents Resulting in Infections.....	138
Chapter 8: Biosafety in China’s High-Containment Laboratories .....	144
Introduction.....	144
1. Biosecurity in China before 2019 Reforms.....	144
2. The Launch of Legislative and Regulatory Reforms in 2018 and 2019 .....	147
3. The Biosecurity Law of the People’s Republic of China: October 2020.....	150
Chapter 9: The Wuhan Institute of Virology & Other Wuhan Institutes with High-Containment Laboratories .....	152
Introduction.....	152
1. Background and Early History of the Wuhan Institute of Virology .....	152
2. Chinese Academy of Science (CAS), WIV’s Parent Agency.....	154
3. WIV Collaborations with PLA-AMMS.....	155
4. Other High-Containment Laboratories in Wuhan.....	157
5. Biosafety Conditions and Practices at the WIV.....	159
a. Background.....	159
b. Evidence of WIV Biosafety Shortcomings Prior to 2019.....	162
6. Chronology of WIV Biosafety Concerns in 2019.....	163
a. March to April 2019: WIV’s BSL-4 Renovations, Annual Safety Training, and Biosafety Patents Filed.....	164
b. Biosafety Concerns June to August 2019 .....	168
c. Inflection Point: September 2019 .....	173
d. Emergence: October-November 2019 .....	178

Chapter 10: Coronavirus & Infectious Disease Research at the WIV .....	183
Introduction & Overview of WIV Coronavirus Research Process .....	183
1. Field Exhibitions and Sample Collection.....	184
2. Screening Viral Samples and Genetic Manipulation .....	184
3. WIV Coronavirus Research 2017-2020.....	186
a. NIH-NIAID Grant: Understanding Risk of Bat Coronavirus Emergence .....	186
b. Other WIV International Coronavirus Collaborations.....	193
c. WIV Funding from PRC Government Agencies .....	195
d. Proposed WIV Coronavirus Research: EcoHealth Alliance Project DEFUSE.....	197
e. Other WIV Research: SARS-related Viral Research in Transgenic Mice and Palm Civets.....	200
Chapter 11: Evidence of Research-Related Event Hypothesis & Outstanding Questions.....	201
Introduction.....	201
a. Research Conducted at the WIV Leading Up to the Pandemic .....	202
b. Delays Between Discovery and Publication in Coronavirus Research.....	204
c. Unpublished SARS-Related Viruses in the WIV Database and Censorship .....	205
2. Likelihood or Evidence of a Research-related Incident at WIV .....	206
a. Background.....	206
b. Biosafety Operational Problems .....	206
c. SARS-CoV-2 Novel Characteristics & BioSafety Precautions .....	211
d. Months Leading Up to the Pandemic: WIV and Government Actions.....	212
3. Plausible Scenarios for Research-related Infection(s) Based on Collected Evidence.....	213
a. Risk of Research-related incidents in Field Collection Expeditions.....	214
b. Infection of a Researcher During Initial Laboratory Evaluation and Characterization of Coronaviruses in BSL-2 Settings.....	215
c. Research-related Incident Due to Escape of an Experimental Animal .....	216
d. Research-related Incident and Researcher Exposure During Animal Experiments.....	217
4. Outstanding Investigative Questions .....	219
a. Is the Presence of a Furin Cleavage Site in SARS-CoV-2 Evidence of Artificial Insertion or Natural Recombination? .....	219
b. Does Early Outbreak Epidemiology Support the Occurrence of Two Discrete Emergences? ..	220
c. Do Contemporaneous Remedial Biosafety-Related Activities to the Outbreak's Initial Emergence Support a Research-related Incident(s)? .....	224
d. Two Plausible Scenarios of Research-related Incidents and Potential Researcher Infection. ..	225

## Muddy Waters Group Investigation Executive Summary

### Introduction

SARS-CoV-2, the virus that causes COVID-19, has caused the deaths of over 1,113,000 Americans. COVID-19 continues to cause serious illness in the U.S. and around the world. Variants of the virus can cause repeated infection in those previously infected as well as vaccinated. Three years after its emergence in Wuhan, exactly how SARS-CoV-2 first emerged as a respiratory pathogen capable of sustained human-to-human transmission remains the subject of active debate.<sup>1</sup> Experts have put forward two dominant theories on the origins of the virus.<sup>2</sup> The first theory is that SARS-CoV-2 is the result of a natural zoonotic spillover.<sup>3</sup> The second theory is that the virus infected humans as the result of a research-related incident.<sup>4</sup>

The information contained in this Source Reference Document reflects 18 months of extensive research and accompanying analyses of these two plausible hypotheses. This document was the product of a multi-disciplinary effort by medical, scientific, legal, political and general policy analysts to catalog open source (unclassified) information relevant to the respective theories. Both hypotheses are plausible. The natural zoonotic spillover hypothesis is weakened by the absence of key epidemiological and genetic data from the Huanan Seafood Market. However, data required to support a natural zoonotic source is dependent on information provided by China, and that is incomplete or contradictory. The preponderance of circumstantial evidence supports an unintentional research-related incident.

#### 1. Epidemiology Favors Late October-Early November Emergence

China's official position is that the COVID-19 outbreak began no earlier than December 8, 2019. Several data sources, however, challenge this assertion. Epidemiological and genetic models indicate that the likely earliest incidence of SARS-CoV-2 human infections occurred mid-October to early, mid-November 2019.<sup>5</sup> Multiple official, technical and media outlet reports similarly suggest a late October to mid-November emergence of the virus.

Epidemiological data supplied by China to the WHO during the China-WHO 2021 joint investigation showed an increase in adult Influenza-Like-Illness (ILI) accompanied by negative laboratory influenza tests during week 46 (November 11 to 17) 2019 from a single adult sentinel Wuhan hospital.<sup>6</sup> This atypical finding, described as an epidemiological outlier, was noted by the WHO Scientific Advisory Group for the Origins of Novel Pathogens (SAGO) in June 2022 as an "unexplained increase in ILI in adults from Wuhan."<sup>7</sup>

In October 2020, epidemiologists published an analysis using China National Health Commission data showing a significant increase in ILI incidence in November 2019. The increase in reported ILI cases occurred at least one month earlier than the clinical reports of pneumonia of unknown cause by China's conventional hospital and outpatient surveillance system.<sup>8</sup> The number of November ILI cases was statistically significantly higher than reported in the previous 5 years (2014–2018). These same researchers recorded the peak of reported COVID-19 illnesses during Week 6 of 2020.<sup>9</sup> The interval from the ILI outlier noted at week 46 to the peak COVID-19 incidence is approximately 13 weeks. The researchers suggested that the November ILI spike were unrecognized initial COVID-19 cases.<sup>10</sup>

Using similar data, U.S. researchers analyzed WHO global influenza surveillance data early in the COVID-19 pandemic. Their study identified similar epidemiological outliers in influenza-negative ILI incidence that served as an early indicator of COVID-19 community transmission.<sup>11</sup> Influenza-negative ILI surveillance data from 16 of 28 countries over a four-year period (2015-2019) identified increases in influenza-negative ILI that occurred on average 13.3 weeks before the occurrence of peak COVID-19 incidence. China was not one of the 28 countries analyzed in their study.

The 13-week interval reflects the average time from the introduction of SARS-CoV-2 to the maximum incidence of recognized cases. COVID-19's clinical characteristics of asymptomatic and low acuity illness for the infected majority and severe disease occurring in a minority with pre-existing conditions may contribute to this apparent latency. In lieu of widespread diagnostic testing, the recognition of its spread would be dependent on the accrual of severe cases over time. The prevalence of the disease circulating in a community would not be recognized until the number of severe cases exceeded existing baselines or hospital capacities.

The ILI increase associated with influenza-negative laboratory tests in Wuhan during Week 46 of 2019 is approximately 13 weeks before the peak incidence of COVID-19 cases in late January-early February 2020 (Weeks 5 and 6 of 2020). Thus, this may represent the initial emergence of SARS-CoV-2 in Wuhan. Validation of this association requires additional data from China and further analysis.

Eyewitness accounts, media reports, epidemiological modeling and additional academic studies further support October 28 to November 10 as the window of emergence. Diplomats stationed at the U.S. Consulate General in Wuhan have attested to observations of what they believed at the time to be the early onset of a 'bad flu' season. The Deputy Consular Chief recalled: "By mid-October 2019, the dedicated team at the U.S. Consulate General in Wuhan knew that the city had been struck by what was thought to be an unusually vicious flu season. The disease worsened in November."<sup>12</sup> These observations were reported to the U.S. Embassy in Beijing during this period.

A January 2021 U.S. Department of State factsheet stated the following: "The U.S. government has reason to believe that several researchers inside the WIV became sick in autumn 2019, before the first identified case of the outbreak, with symptoms consistent with both COVID-19 and common seasonal illnesses."<sup>13</sup> A June 2020 published Harvard University study found an unusual increase in Wuhan hospital traffic during the same period.<sup>14</sup> Satellite imagery showed a significant increase in vehicles parked at major Wuhan hospitals – an indicator previously established as a proxy for hospital occupancy rates – in this period compared to October and November of 2018.<sup>15</sup> Search queries made on the Chinese search engine *Baidu* for terms like "cough" also increased substantially in October and November, 2019.<sup>16</sup>

In August 2021, a veteran *Washington Post* policy columnist reported that at least one of the WIV researchers became ill in early November, 2019 and exhibited symptoms highly specific to COVID-19, including the loss of smell and ground-glass opacities in his lungs.<sup>17</sup> The Office of the Director of National Intelligence's (ODNI) Updated Assessment on COVID-19 Origins cautioned that "information indicating that several WIV researchers reported symptoms consistent with COVID-19 in the Fall of 2019



is not diagnostic of the pandemic's origins. "Even if confirmed, hospital admission alone would not be diagnostic of COVID-19 infection."<sup>18</sup>

Several media reports provided further suggestive evidence. An Australian journalist interviewed a frontline Wuhan doctor who conveyed that he and his colleagues saw a growing number of patients exhibiting fever and respiratory difficulties in early November, 2019.<sup>19</sup> The physicians realized that a coronavirus, likely SARS, was the causative agent by early December.<sup>20</sup> Further, a Wuhan University biostatistics professor gave an interview in which he discussed his work to compile a nationwide database of COVID-19 cases.<sup>21</sup> According to the epidemiologist, several suspected cases predated the earliest official cases in December, 2019. "There were two patient cases in November, with onset on November 14 and November 21, 2019, and five or six cases before December 8, 2019."<sup>22</sup> Two other media outlets published information from leaked hospital data from pneumonia patients in Wuhan with suspected COVID-19. These reports identified two separate suspected case-clusters in early October and November 2019.<sup>23,24</sup>

Unpublished People's Republic of China (PRC) Government data identified the first COVID-19 case in mid-November. A veteran *South China Morning Post* reporter reviewed an official China CDC document that showed a 55-year-old from Hubei province contracted the virus on November 17, 2019. It is the supposed earliest publicly confirmed case of COVID-19.<sup>25</sup> On November 25, 2019, a 25-year-old Welsh teacher in Wuhan fell ill with flu-like symptoms. The teacher developed pneumonia on December 6, 2019 and was hospitalized.<sup>26</sup> On January 16, 2020, the hospital informed the teacher by letter that he had been infected by the novel coronavirus.<sup>27</sup> The timing of the initial COVID-19 cases is not by itself revealing of the origins of the virus.

## 2. Precedent of Zoonotic Spillovers & Likelihood of an Animal Origin

In a vacuum, the natural zoonotic spillover hypothesis is a plausible explanation for how the COVID-19 pandemic started. Applied to the facts here, however, there are a number of gaps and anomalies in the SARS-CoV-2 outbreak. The early COVID-19 pandemic is different compared to the emergence of infectious diseases via past natural zoonotic spillovers, most notably the 2003-2004 SARS-CoV outbreak.

Recent natural zoonotic spillovers of respiratory viruses with pandemic potential have left behind evidence of where and how they occurred.<sup>28</sup> Though the number of such occurrences is relatively few, early or failed animal-to-human transmissions, or "dead-end" spillovers, typically leave behind serological evidence. This evidence is in the form of antibodies in humans and animals that were exposed and infected but did not effectively transmit the virus to others.<sup>29</sup> Failed transmissions also typically leave behind genetic evidence.<sup>30</sup> Samples retrieved from infected humans during the 2003-2004 SARS outbreak contained genetic mutations that reflected its circulation and adaptation in palm civets, the intermediate species, for example.<sup>31</sup>

It would be expected that environmental samples collected from wet markets that were positive for SARS-CoV-2 would likely show evidence of animal genetic adaptation. A study authored by the former Director of China's CDC George Fu Gao, analyzed 1,380 samples collected from the environment

(923) and animals (457) within the Huanan Seafood Market in early 2020. His study identified 73 SARS-CoV-2 positive environmental samples. Three live viruses were successfully isolated from these environmental samples. None of the samples taken from the 18 animal species found in the market were positive for SARS-CoV-2. The three live viruses from environmental isolates were sequenced. These viruses shared 99.980% to 99.993% similarity with human isolates recovered from Wuhan (HCoV/Wuhan/IVDC-HB-01) and showed no evidence of animal adaptation.<sup>32</sup>

Two sets of evidence that have been used to support a spillover origin are discussed later in this report: the location in the market where positive environment detections of SARS-CoV-2 were obtained; and the existence of two lineages of SARS-CoV-2 among the earliest known cases.

Like the 2003 SARS outbreak, H7N9 influenza, first reported in China in March 2013, started with multiple independent viral introductions into humans across multiple disparate locations. The total number of human H7N9 infections numbered less than 500.<sup>33</sup> The natural zoonotic spillovers of 2003 SARS and 2013 H7N9 influenza occurred in multiple locations over several months, while the SARS-CoV-2 outbreak originated in one location, Wuhan, over a few weeks.

A number of epidemiologists, virologists and, at first, the Chinese government have asserted that the COVID-19 pandemic originated from a natural zoonotic spillover occurring at the Huanan Seafood Market in mid- to late December 2019. They declared that this was the origin of the pandemic.<sup>34</sup> China Government officials have subsequently asserted that SARS-CoV-2 was imported on the surface of frozen seafood, by infected people or animals or originated from a U.S. military laboratory. Support for these alternative theories is limited to government-controlled publications in China and are not credible.<sup>35</sup> The limited epidemiological data provided by PRC officials continues to hamstring efforts to better understand the early trajectory of the virus. PRC officials continue to suppress and manipulate COVID-19 data.

As recently as January 2023, *Reuters* reported that “China’s COVID-19 data is not giving an accurate picture of the situation there and underrepresents the number of hospitalizations and deaths from the disease, a senior official at the World Health Organization said...”<sup>36</sup> As stated in the WHO’s June 2022, Scientific Advisory Group for the Origins of Novel Pathogens report: “To date, neither the virus progenitors nor the natural/intermediate hosts have been identified.”<sup>37</sup>

The absence of key epidemiological and genetic data of the initial outbreak raises questions about the likelihood of the Huanan Seafood Market serving as the location of SARS-CoV-2 emergence. Data supports the presence of potential susceptible animals such as palm civets and raccoon dogs at the Huanan Seafood Market. There have been no documented positive SARS-CoV-2 animal samples from any Wuhan wet market. Nor have vendors of these animals tested positive. Further, the suspected natural hosts, bats or pangolins, were not sold at the Huanan market. The initial response efforts by local authorities to immediately close the market, remove all live animals and sanitize the facility could have impacted the likelihood of recovering viable environmental samples.<sup>38</sup> The genetic sequencing of environmental samples recovered from the Huanan market, however, shows them identical to recovered human clinical samples.<sup>39</sup>

To date, China has not acknowledged the infection or positive serological sample(s) of any susceptible animal prior to the recognized outbreak. Genetic analysis of published SARS-CoV-2 sequences from the early outbreak does not show evidence of genetic adaptation reflecting passage through a susceptible animal species such as a palm civet, raccoon dog or mink.<sup>40,41</sup> To this end, no intermediate host has been identified.<sup>42</sup>

Despite these facts, three data points do present themselves to support the zoonotic origin theory. First, approximately 33 percent of the earliest known human COVID-19 cases (with symptom onset dates in mid- to late-December 2019) were associated with the Huanan Seafood Market in Wuhan.<sup>43</sup> Second, several animal species susceptible to SARS-CoV-2 were sold live and in poor animal welfare conditions at the market.<sup>44</sup> Finally, the identification of genetic sequences of raccoon dogs in samples taken from the market in early 2020 confirm that this susceptible intermediate host was at the market at the time of the outbreak. As noted, “there is no data...associating SARS-CoV-2 with the presence of any of these animals.”<sup>45</sup> These data themselves, however, do not explain the origin of the COVID-19 pandemic.

### 3. Plausibility of a Research-related Incident & Laboratory-acquired infections

There are a substantial number and diverse ways research-related incidents can occur.<sup>46</sup> Incidents that result in infections are classified as laboratory-acquired infections. According to published research, the cause of **over 80% of laboratory-acquired infections (LAI) are never conclusively determined.**<sup>47</sup> Only 18% of the infections were due to identified accidents caused by carelessness or human error.<sup>48</sup> Factors that contribute to the risk of such incidents are several-fold. Younger workers, those with less technical training and men experience more accidents than older workers, those with more training or women.<sup>49</sup> The recognition and isolation of a new infectious agent can result in a LAI caused by the new isolate but not be recognized, for example.<sup>50</sup>

The risk of exposures to infectious agents is a function of safety training, safe work practices, safety equipment and laboratory design. Infectious agent research includes exposures to higher concentrations of infectious agents than found in clinical diagnostic laboratories.<sup>51</sup> The common routes of exposure are ingestion, percutaneous inoculation (needle-sticks, cuts, animal scratches and bites) and inhalation.<sup>52</sup> Of these, inhalation represents the most insidious avenue of infection because aerosols and droplets are often invisible and difficult to detect.<sup>53</sup>

China’s entry into highly pathogenic agent research did not formerly start until the 1980’s, several decades after many developed countries began their efforts.<sup>54</sup> China lagged behind in biosafety concepts, relevant standards, practices for high-containment laboratories and research and development of biosafety equipment.<sup>55</sup> As a consequence, China could only domestically produce a portion of biosafety equipment needed and were dependent on foreign sources.

After the 2003 SARS outbreak, China prioritized constructing a national network of biosafety containment laboratories. It created an expert laboratory biosafety team. Laboratory biosafety laws, regulations, standards, and guidelines were drafted and published. Despite these achievements, China’s progress in biosafety advanced slower than its aspirations for and efforts in research of highly pathogenic microorganisms. Its capacity for innovation remained weak.<sup>56</sup> The creation of independent intellectual

property rights supporting research and development of domestic biosafety techniques and equipment fell short of western countries.<sup>57</sup> China still faced many laboratory biosafety challenges that was subject to both international and national concern.

While any laboratory is susceptible to LAI's, as early as 2015, some western scientists called into question whether the potential benefits to be gained from the WIV's coronavirus research involving the genetic manipulation and creation of chimeric viruses was worth the considerable risks to public health.<sup>58</sup> In 2017, other scientists warned of the potential dual-use applications of such research, and worried about "pathogens escaping" in light of China's history of laboratory leaks, particularly several LAI involving SARS.<sup>59</sup> These warnings coincided with the opening of the WIV's Biosafety Level (BSL) 4 laboratory in January 2017.<sup>60</sup> A January 2018 U.S. Department of State cable reported that "the new lab had a serious shortage of appropriately trained technicians and investigators needed to safely operate this high-containment laboratory."<sup>61</sup> The cable further cautioned that the WIV's work with bat coronaviruses potentially posed a risk of a SARS-related pandemic.<sup>62</sup> The WIV's research focused principally on bat coronaviruses, but other Wuhan institutes (Wuhan and Huazhong Agricultural Universities) and agencies (Hubei and Wuhan Centers for Disease Control) conducted research on animal-related coronaviruses.

In March 2019, then CCDC Director George Gao warned about potential natural, accidental, and deliberate biological threats. He specifically identified laboratory risks:

A potential major risk stems from stocks of concentrated infectious pathogens stored in laboratories and the absence of adequate biosecurity measures. Non-compliance of approved biocontainment and biosafety protocols could result in accidental or deliberate release of pathogens into the environment...[G]enetic modification of pathogens, which may expand host range as well as increase transmission and virulence, may result in new risks for epidemics...synthetic bat-origin SARS-like coronaviruses acquired an increased capability to infect human cells. Thus, modifying the genomes of animals (including humans), plants, and microbes (including pathogens) must be highly regulated.<sup>63</sup>

In May 2019, Yuan Zhiming, the General Secretary of the Communist Party of China (CCP) Committee of the Wuhan Branch of the Chinese Academy of Sciences (CAS), thus responsible for oversight of CAS activities in Wuhan, and Director of the WIV National Biosafety Laboratory (BSL-4); echoed Gao's concerns. Zhiming specifically expressed issues with China's biocontainment labs. He described uncertain funding for laboratory construction, operation, and maintenance. He highlighted neglected maintenance, insufficient operational funds, and a lack of specialized managers and engineers to operate BSL-3 labs.<sup>64</sup> Zhiming also urged authorities to "promptly revise the existing regulations, guidelines, norms, and standards of biosafety and biosecurity."<sup>65</sup>

On April 3, 2019, the WIV held its annual conference on laboratory security and safety.<sup>66</sup> The WIV's director delivered opening remarks stating that "the safety work of the institute is the precondition and guarantee for succeeding at all of the other work at the institute."<sup>67</sup> She continued with the theme of holding researchers accountable for safety incidents, demanding that, "all operations inside the laboratory

must be carried out in strict adherence to professional standards and procedures with no tolerance for any kind of wishful thinking and that steps must be taken, to strengthen safety management for students.”<sup>68</sup>

That same month, the WIV submitted 13 of 17 total patents submitted in 2019 for biosafety related improvements. The applications covered a range of remedial actions for physical containment (hermetically sealed doors), wastewater treatment, decontamination (autoclaves and chemical showers), and maintaining negative air pressure in the high-containment laboratories (exhaust air management). The number of patents, by itself, is not unusual. High-containment laboratories constantly seek to improve, through innovation, the biosafety posture of their facility. The nature of the issues and problems the WIV was remediating is revealing to their state of biosafety at that time.

One patent addressed the problem of maintaining airtight seals on gas-tight doors and cites the potential problem of existing door seals that developed slow leaks over time. Another patent addressed developing a manually operated auxiliary exhaust fan to maintain negative pressure and improve disinfection of biosecurity laboratories’ HEPA filters.<sup>69</sup> Another described improving the design and operation of biosafety autoclave sterilizers. This patent described problems of being unable to achieve required sterilization temperatures, potential leaks around the autoclave doors and excessive condensation of autoclaved infectious materials.<sup>70</sup>

Despite these apparent biosafety challenges, the WIV’s research continued apace to identify potential human pandemic-causing SARS-related coronaviruses and medical countermeasures to mitigate them. In pursuit of this task, researchers collected hundreds of SARS-related bat coronaviruses from across China and Southeast Asia. The risk of research-related incidents begins with field expeditions where researchers first collect bat samples. The WIV and other Wuhan institute (CCDC) researchers operated in a challenging setting with limited light and sometimes only with partial personal protective equipment and exposed skin. It also placed researchers at considerable risk for potential bites, scratches and needle-stick injuries while collecting field samples from bats.

As a result of field expeditions by 2019, the WIV had collected, at a minimum, approximately 20,000 bat and other animal virus samples from across China.<sup>71</sup> The WIV’s formerly public database reportedly contained more than 2,000 entries consisting of sample and pathogen data, including full and partial viral genomic sequences, collected from bats and mice. The database also reportedly held an estimated 100 unpublished sequences of the beta-coronavirus subgenus to which SARS-CoV-2 belongs.<sup>72</sup> The existence of these undisclosed sequences raises the possibility that strains may exist that are closer progenitors to SARS-CoV-2.

After collection, samples were transported back to Wuhan. These isolates routinely underwent initial evaluation in BSL-2 settings where they were first evaluated, usually by graduate students, for the presence of SARS-related beta coronaviruses. If viruses were present, researchers then attempted to isolate and sequence the virus.<sup>73</sup> Full length viruses were then grown in a variety of cell cultures including human cells to assess the ability to infect different cell types. Viruses that could infect human cells would then be tested for pathogenicity in humanized mice or susceptible intermediate hosts such as palm civets in BSL-3 laboratories.<sup>74</sup> Finally, researchers evaluated the effectiveness of existing medical countermeasures against these newly discovered viruses.

If researchers failed to recover a full-length viral sequence, they would attempt to isolate the spike protein or the part of the spike that attached to the cell (the receptor binding domain) of the discovered viral fragment. To evaluate the pandemic potential of non-viable coronavirus fragments, researchers spliced the sequence of the spike protein or its receptor binding domain onto already characterized viable SARS-related viruses creating chimeric viruses that could grow in cell culture.<sup>75</sup> Starting no later than 2017, WIV researchers created chimeric viruses that had potentially greater human affinity (transmissibility) and virulence.<sup>76</sup> The resulting chimeric SARS-related viruses would then be evaluated for its infectivity in human cells and pathogenicity in humanized mice.

In 2018, their research interests expanded with the intent to artificially insert genetic sequences for human furin cleavage sites to evaluate their pandemic causing potential in SARS-related coronaviruses. Furin cleavage sites (FCS) are found in other human pathogens such as avian influenza, HIV and Ebola viruses and are known to increase their infectivity.<sup>77</sup> In 2018, no SARS-related virus had been found with a complete FCS. Another Wuhan research institute demonstrated the precedent of inserting an FCS into an animal (pig) alpha coronavirus in 2015, for example.<sup>78</sup>

In March 2018, EcoHealth Alliance with the WIV as a collaborating institute submitted a grant proposal titled “Project DEFUSE: Defusing the Threat of Bat-borne Coronaviruses” to the Defense Advanced Research Projects Agency (DARPA).<sup>79</sup> Beside expanding the process of evaluating newly discovered spike proteins on chimeric SARS-related viruses, researchers proposed artificially inserting “human-specific” FCS to evaluate their effects on viral growth in human cells and pathogenicity in humanized mice.<sup>80</sup> These experiments could create chimeric SARS-related viruses with FCS that had not yet been found or perhaps did not exist in nature. DARPA did not approve or fund this proposal.

One of the notable genetic findings of SARS-CoV-2 is the presence of an FCS. It is the first SARS-related beta coronavirus found with one.<sup>81</sup> Its presence in SARS-CoV-2 has been the subject of active scientific and public debate since the beginning of the pandemic. It is assessed to be an essential characteristic resulting in the high human infectivity and pathogenesis of SARS-CoV-2.<sup>82</sup> “The presence of a furin cleavage [site]... is therefore highly unusual, leading to the smoking gun hypothesis of manipulation that has recently gained considerable attention as a possible origin of SARS-CoV-2.”<sup>83</sup> The intent to insert an FCS highlights the additional risks experimenting with chimeric viruses with enhanced infectivity.

Widely accepted biosafety guidelines hold that initial evaluation of SARS-related bat coronaviruses should be conducted in at least BSL-3 laboratories because of the risk of creating infectious aerosols.<sup>84</sup> National Institute of Health guidelines specify, however, that research that create chimeric SARS-related coronaviruses that results in a virus that can infect human lung cell culture or humanized mice should be conducted in BSL-3 level conditions or above.<sup>85</sup> Experiments conducted at enhanced BSL-3 conditions at a U.S. university in 2015, spliced a spike protein from a fragment of a SARS-related virus onto a viable (backbone) beta coronavirus that was then grown in culture. Performing this experiment at an enhanced BSL-3 level was justified because the resulting SARS-related chimeric virus could infect human airway cells and had the potential to “cause pathogenesis *in vivo* and escape current therapeutics.”<sup>86</sup>

By contrast, the WIV's biosafety guidelines apparently allowed its researchers, including graduate students, to conduct initial evaluation of SARS-related bat coronaviruses in BSL-2 laboratories.<sup>87</sup> For example, a WIV graduate student conducted similar coronavirus research as the U.S. university, creating chimeric SARS-related viruses able to infect human cells.<sup>88</sup> The WIV graduate student described the process of "rescuing" coronaviruses that were difficult to isolate, adapt and grow in a laboratory in a 2017 dissertation.<sup>89</sup> The student indicated that "[t]he proliferation and cell infection experiments of live [SARS-related] virus (including recombinant viruses) were performed in [WIV's] BSL-2...laboratory in compliance with [WIV] biosafety regulations."<sup>90</sup> In a written interview provided to *Science* and published July 31, 2020, Shi Zhengli confirmed that at least some of the WIV's coronavirus research were performed in BSL-2 conditions.<sup>91</sup> Only after the outbreak of COVID-19 did laboratory safety guidelines in China require coronavirus research to be conducted at minimum of BSL-3 conditions.<sup>92</sup>

At least until the COVID-19 pandemic, it is apparent that researchers at the WIV were working with SARS-related coronaviruses in inappropriate biosafety levels. One goal of this research was to identify and evaluate SARS-related viruses that were more capable of infecting human cells. In the two years leading up to the pandemic, publications by and interviews with WIV's researchers attest to increasingly sophisticated coronavirus experiments using humanized mice, bats, and palm civets to achieve this goal.<sup>93,94</sup>

#### **4. Summation of Events Leading to the Pandemic**

The full scope and scale of animal experiments conducted at the WIV in 2018 and 2019 are unclear. As of 2018, the WIV was infecting transgenic mice that expressed human ACE2 receptors, the receptors known to be utilized by SARS coronaviruses to gain entry into human cells and palm civets with chimeric SARS-related coronaviruses.<sup>95</sup> The limited published information on the results of these experiments indicate that SARS-related bat coronaviruses could infect and cause low pathogenicity in humanized mice and no pathogenicity in civets.<sup>96</sup> The full results of these experiments have never been published even though Shi Zhengli said they would be.<sup>97</sup> Consequently, the WIV as a sub-grantee of NIH grants, was terminated for failing to produce its laboratory notes and other records relating to these experiments.<sup>98</sup>

Nonetheless, it is clear that the convergence of sophisticated coronavirus research, government demands for scientific breakthroughs and biosafety problems at the WIV appears to have peaked in the late-summer or early-fall of 2019.<sup>99</sup> From June to August, 2019, WIV leadership published multiple reports expressing concerns about biosafety shortcomings due to limited availability of equipment and trained personnel.<sup>100</sup> Multiple PRC government medical and public health entities in Wuhan began procuring pathogen detection (polymerase chain reaction-PCR) instruments and conducting infectious disease outbreak exercises and drills.<sup>101</sup>

In mid-September of 2019, the WIV took their sample and sequence database offline and enhanced physical security of its campus. Wuhan officials conducted an emergency response drill on September 18, 2019 at its international airport that included identifying and responding to an arriving

passenger infected with a novel coronavirus.<sup>102</sup> Also in September 2019, China's National People's Congress reviewed draft legislation to strengthen the management of laboratories involved in pathogen research and improve adherence to national standards and requirements for biosafety. It specified that:

[L]ow-level pathogenic microorganism laboratories shall not engage in pathogenic microorganism experiments that should be conducted in high-level pathogenic microorganism laboratories...High-level pathogenic microorganism laboratories engaging in experimental activities of highly pathogenic or suspected highly pathogenic microorganisms shall be approved by the health or agriculture and rural authorities at or above the provincial level. For pathogenic microorganisms that have not been discovered [not found in nature] or have been eliminated...relevant experimental activities shall not be carried out without approval.<sup>103</sup>

During the week of November 11 to 17, 2019, two publications of interest were noted. A November 12, 2019 report first published in August 2019 was reposted by the WIV BSL-4 laboratory's Communist Party Branch. It explicitly referenced the challenges that the researchers had to overcome in establishing their laboratory: the "three no's." As they described it, "no equipment and technology standards, no design and construction teams, and no experience operating or maintaining" a high-containment laboratory.<sup>104</sup> In this same post, they described overcoming these challenges but unlike the August version it detailed the risk of potential laboratory leaks and infections and possible past biosafety incidents involving "high pathogen microorganisms."<sup>105</sup> The post also described that "every time this has happened" the BSL-4 Party members would respond.<sup>106</sup>

A few days later, a second article was published on November 15, 2019 in a Wuhan daily newspaper. Entitled "Explore the Institute of Model Animals of Wuhan University, which *used* to be one of the battlefields against SARS" (emphasis added). The article detailed the historic role of the Institute in SARS-related vaccine research. It also stated that the animal BSL-3 laboratory had undergone renovations in 2015 and was "currently" awaiting "final process of re-approval."<sup>107</sup> This inaccurate, possibly deceptive story, contradicts 2018 published research in the journal *Virologica Sinica* describing a SARS-related vaccine challenge study in Rhesus monkeys performed at the University's Institute in 2017.<sup>108</sup>

On November 19, 2019, the WIV hosted a special senior leadership biosafety and security training session. The session was led by the senior CAS biosafety/biosecurity official who traveled from Beijing to relay "important oral and written instructions" (*pishi*) from senior PRC leadership to the WIV regarding the "complex and grave situation facing [bio]security work".<sup>109</sup> From the report, CCP leadership were made aware of "safety and security work" issues at the WIV.<sup>110</sup> At the same session, the Deputy Director of the WIV's Office of Safety and Security "pointed to the severe consequences that could result from hidden safety dangers, and stressed that the rectification of hidden safety risks must be thorough, and management standards must be maintained."<sup>111</sup> The November 19, 2019 senior leadership session was followed by a two and a half day remedial biosafety training course for WIV researchers and individuals from other Wuhan research institutes, including the Wuhan University.



November 19, 2019 is the same day that the WIV issued a short suspense, sole source procurement notice for an air incinerator to address some problem or failure of a biosafety autoclave at the WIV's original downtown campus. The need to install air incineration to the autoclave exhaust after serial HEPA filtration suggests some concern about the risk of an infectious aerosol escape. This procurement may be related to an April 2019 WIV patent describing changes in the design and operation of biosafety autoclaves at the WIV.<sup>112</sup> The changes appear to be at variance with standard biosafety autoclave procedures.

Two other WIV patents submitted on November 15, and December 11, 2019 address the potential for research-related accidental puncture wounds and a failure of HEPA filtration for specialized animal-related biocontainment transportation equipment due to possible corrosion.<sup>113,114</sup> These patents raise the possibility of other potential biosafety issues occurring contemporaneously with the initial outbreak of SARS-CoV-2.

An additional WIV patent submitted a year later on November 13, 2020, outlined the need to reformulate a liquid disinfectant used in high containment laboratories. As described, long-term use of the disinfectant caused "corrosion of metal components such as stainless steel, thereby reducing the protection of ... facilities and equipment...shorten its service life and cause economic losses, but also lead to the escape of highly pathogenic microorganisms into the external environment of the laboratory, resulting in loss of life and property and serious social problems."<sup>115</sup> Whether this particular WIV patent reflects remedial actions to address corrosion problems identified in the December 2019 patent is not known.

November 2019 also appears to be the timeframe that PLA researchers began development of at least two SARS-CoV-2 vaccines. People's Liberation Army (PLA) Professor Zhou Yusen, Director of the 5th Institute at the Academy of Military Medical Sciences (AMMS), worked with the WIV, and possibly at the WIV, episodically, for several years prior to the pandemic.<sup>116</sup> Zhou or AMMS researchers may have been working at the WIV no later than the Fall of 2019 conducting research for a paper that he coauthored with two WIV researchers, Shi Zhengli and Chen Jing, on a known adverse effect of SARS-related vaccines and antibody treatments.<sup>117</sup> There is reason to believe Zhou was engaged in SARS-related coronavirus animal vaccine research with WIV researchers beginning no later than the Summer or early Fall of 2019. Zhou submitted one of the first COVID-19 vaccine patents on February 24, 2020.<sup>118</sup>

The patent includes mouse-derived serological data from vaccine-related experiments which experts, consulted with during this investigation, assess could not have been completed unless Zhou's team began work on vaccine development before the known outbreak of the COVID-19 pandemic in late-December 2019. The research required both access to the sequence of and the live SARS-CoV-2 virus. Several experts assessed that Zhou likely would have had to start this vaccine development research no later than November 2019 to achieve the February patent submission date. Zhou later published transgenic mouse infection and vaccine challenge studies in mice, including humanized mice and non-human primates.<sup>119,120,121</sup> The location(s) where Zhou's animal vaccine challenge studies were performed was not disclosed.<sup>122,123</sup> There is reason to believe that these vaccine experiments were performed at the original WIV's downtown Wuhan campus and possibly at the Wuhan University Institute of Animal Models located approximately a mile from the WIV.

PLA AMMS Major General Wei Chen led a second, separate, effort to develop another candidate COVID-19 vaccine. Chen collaborated with the China state-owned biopharmaceutical company SinoPharm. Chen's vaccine experiments with humanized mice, ferrets and non-human primates occurred at the Harbin veterinary research facility BSL-4 laboratory in northern China.<sup>124</sup> Human clinical trials began in mid-March 2020. Chen submitted a patent for her vaccine March 18, 2020.<sup>125</sup> Based on this timeline, experts believe Chen would have had to begin her vaccine efforts no later than early December 2019. Chen's vaccine candidate was also dependent on the availability of SARS-CoV-2's genetic sequence that would not be published until January 11, 2020. However, unlike Zhou, there is no evidence that Chen's vaccine efforts were associated geographically or temporally with the initial COVID-19 outbreak in Wuhan.

During the same time period as experts suggest Zhou began vaccine development against a SARS-related coronavirus in late fall 2019, likely at the WIV, Wuhan experienced an increased incidence of influenza-like-illness (ILI).<sup>126</sup> The U.S. State Department and other media reporting indicated cases of COVID-19 may have occurred as of mid- to late October or early to mid-November 2019.<sup>127,128</sup> As noted earlier, an ILI spike coincided with negative influenza reporting for week 46 of 2019 (November 11 to 17). This epidemiological outlier comports with published analysis suggesting it may be an early indicator of COVID-19 community transmission.<sup>129</sup> This increased ILI incidence occurs approximately 13 weeks before the recorded surge of COVID-19 cases in Wuhan in early February 2020. Validation of this finding, however, is precluded by the lack of access to the underlying source data provided to the WHO from China.

Despite evidence supporting the plausibility of both hypotheses, critical gaps in data and information remain particularly substantiating a zoonotic outbreak. Further investigation and examination are required to address outstanding questions pertaining to both possibilities. The confluence of potential ILI incidence in Wuhan in early to mid-November coincides with anecdotal reports of early cases of COVID-19. It also comports with several accepted epidemiological and molecular models estimating COVID-19 initial emergence in Wuhan. It also coincides with remedial and response-related actions taken by WIV and PRC governmental officials.

The preponderance of information supports the plausibility of an unintentional research-related incident that likely resulted from failures of biosafety containment during SARS-CoV-2 vaccine-related research. The identified underlying biosafety issues increased the likelihood that such containment failures were not immediately recognized. The possibility of unrecognized biocontainment breaches combined with SARS-CoV-2's clinical characteristics of asymptomatic and mild clinical illness in the majority of infections, likely confounded early recognition and containment of the initial outbreak. Such initial unrecognized infections could serve as the nidus of the outbreak of COVID-19 in Wuhan and is a plausible proximate cause of the pandemic.

**a. Table 1. Pros & Cons of Zoonotic Origin Hypothesis**

<b>PROS</b>	<b>CONS</b>
Historical Precedent; SARS & MERS	No animal intermediate host identified:
Bat coronavirus like RaTG-13 & Banal series with >96% similarity to SARS-CoV-2 found in nature	No animal or human serological (antibody) evidence of infection in either human or animals associated with the live animal supply chain of the Huanan animal market prior to the recognized outbreak
Presence of susceptible (palm civets, raccoon dogs & mink) live animal markets in Wuhan	Timing: December market associated cases unlikely first cases of COVID-19
Wet Market animals maintained in poor conditions	Geography: Location of outbreak (Wuhan) considered negligible risk for natural bat coronavirus emergence
Positive environmental samples from the market from the western section that traded wildlife/animal products implicating the presence of racoon dogs in proximity of environmental samples positive for SARS-CoV-2	Lack of genetic adaptation to animal species (higher initial affinity for human tropism & transmission SARS-CoV-2 > SARS)
Mutations post human spillover increased viral fitness in humans	Lack of multiple emergence/introduction events found in previous zoonotic related outbreaks.
	Lack of documented infection in wet market animals or animal vendors or handlers
	Presence of Furin Cleavage Site
	High degree of human homology of environmental samples from the Huanan Seafood Market center around bathrooms
	China's competence investigating previous zoonotic outbreaks. (e.g., 2016 & 2019 Swine Acute Diarrheal Syndrome)

**b. Table 2. Pro & Cons of Research-related Origin Hypothesis**

<b>PROS</b>	<b>CONS</b>
Biosafety issues at the WIV & other laboratories	Lack of published/known precursor or backbone virus like SARS-CoV-2 at the WIV
Required remedial biosafety training & possible corrective actions (air incinerator etc.)	Zoonotic Historical Precedent; SARS & MERS
Documented WIV Coronavirus recombinant research	Bat coronavirus like RaTG-13 & Banal series found in nature
Conducted in BSL-2 settings	Presence of susceptible (palm civets, raccoon dogs & mink) live animal markets in Wuhan
Geography: Location of outbreak in Wuhan (Wuchang District)	Wet Market susceptible animals maintained in poor conditions
Presence of Furin Cleavage Site	
High degree of genetic homology of initial strains	
Animal cases secondary to human exposure (mink, cats, hamsters etc.)	
Flawed high-containment (BSL-3 & 4) laboratory design with possible documented biocontainment failures/vulnerabilities	
Reports of WIV researchers becoming ill with symptoms and clinical findings (loss of small and ground-glass opacities on chest x-rays)	

## Introduction

Part I of this reference document covers a number of matters relevant to the origins of SARS-CoV-2 and consists of six Chapters. Chapter 1 provides background information related to SARS-CoV-2, including an explanation of the unusual genomic features that contribute to SARS-CoV-2's pandemic potential. Chapter 2 examines the available evidence in an effort to create as comprehensive of timeline into the initial outbreak of SARS-CoV-2 in Wuhan as is possible. Chapter 3 details anomalies and shortcomings in China's response to the initial outbreak of SARS-CoV-2 so as to provide context for why critical information that would shed light on the origins of SARS-CoV-2 is not available.

Chapters 4, 5, and 6 address the available evidence in support of the hypothesis that SARS-CoV-2 infected humans as the result of a zoonotic spillover from an as yet unidentified animal.

Chapter 4 serves as an introduction to the zoonotic hypothesis and details past zoonotic spillover events, such as the 2002-2004 SARS epidemic. It provides an overview of China's public health system and infectious disease surveillance program. Lastly Chapter 4 provides summaries of more recent zoonotic spillovers with an emphasis on the response to such events by the Government of the People's Republic of China (PRC).

Chapter 5 reviews the available evidence on the investigations and data released by the PRC to date on the origins of SARS-CoV-2. The first section details the early investigations by PRC public health officials and scientists into the role of the Huanan Seafood Market. This section includes evidence of live animal sales at the market and a review of the evidence that the Huanan Market, or its supply chain, were the location of the zoonotic spillover of SARS-CoV-2. The second section details the available information on retrospective investigations by PRC public health officials, including their failure to find any evidence that SARS-CoV-2 circulate in humans prior to December 2019. The third section reviews the results of animal surveys conducted by PRC scientists to identify the intermediate host of SARS-CoV-2, as well as studies on SARS-CoV-2 infections and transmission in various animal species, including experimental infections and natural infections caused by human-to-animal transmission of the virus. Finally, this section also evaluates the leading candidate intermediate host species based on susceptibility to SARS-CoV-2 and evidence that the species was in the Huanan Market and Wuhan area live market supply chain.

Lastly, Chapter 6 examines the available evidence in support of a zoonotic origin for SARS-CoV-2. It is organized into three sections. The first section outlines the hypothetical spillover pathway of SARS-CoV-2 from its most likely viral reservoir in horseshoe bats in Southern China and Southeast Asia to Wuhan. The second section identifies critical evidentiary gaps that prevent this investigation from concluding that the SARS-CoV-2 pandemic is the result of the natural spillover of SARS-CoV-2. The third and final section details outstanding questions that, if answered, would increase confidence in the possibility of a zoonotic origin for the pandemic.

Part II of this reference document will examine the available evidence that SARS-CoV-2 emerged as the result of a research-related incident at the Wuhan Institute of Virology or one of the

several other research institutes conducting coronavirus research located in Wuhan. Part II consists of four chapters.

Chapter 7 serves as an introduction to Part II. It provides an overview of how research-related incidents, where a researcher is exposed or infected with an agent, occur in high-containment laboratories. Chapter 7 also explains the history of high-containment laboratories, including notable past laboratory accidents, as well as the differences between the four biosafety levels and the key principles of biosafety design.

Chapter 8 summarizes the development of China's high-containment laboratories and biosafety framework. This chapter includes a review of China's efforts to reform and improve safety regulations in high-containment laboratories and primary source accounts of shortcomings and challenges in China's management of high-containment laboratories.

Chapter 9 provides an overview of the Wuhan Institute of Virology, including its history and laboratories. Chapter 9 also identifies other Wuhan area research institutes that conduct coronavirus research, the most relevant of which may be Wuhan University. This chapter's final section details information this investigation was able to uncover regarding biosafety problems at the WIV in the months and years leading up to the pandemic.

Chapter 10 details available information regarding the WIV's coronavirus research projects. The chapter examines the full spectrum of WIV coronavirus research, from the WIV's virus hunting expeditions in Southern China and Southeast Asia through to viral growth experiments involving humanized mice and other animal models. Chapter 10 also looks at collaborations between the WIV and western research collaborators and the sophisticated research the WIV was undertaking in 2018-2019 with coronaviruses.

Finally, Chapter 11 combines the information and evidence presented in Chapters 7 through 10 to identify the most likely ways that a research-related incident could have started the COVID-19 pandemic. Chapter 11 is divided into four sections. The first section of this chapter examines the possibility that the WIV may have had SARS-CoV-2 or a close progenitor virus in its possession prior to October to November, 2019. Section two identifies potential risks by analyzing specific published WIV research, internal reports, procurements, intellectual property and available epidemiological data and modeling. Internal WIV administrative and Chinese Communist Party (CCP) branch reports uncovered during this investigation and WIV patents and procurements suggest officials were aware of a variety biosafety and biosecurity deficiencies that needed to be remediated.

Section three presents scenarios based on available evidence to illustrate how research-related incidents might have resulted in human infection(s) with the virus. The fourth section identifies outstanding questions relating to the plausibility of a research-related incident. It identifies critical gaps in information and understanding of the origins of SARS-CoV-2 and the pandemic. Addressing these gaps could provide greater clarity and certainty into the origins of the virus and the circumstances around the outbreak.

## Methodology

The investigation followed two established analytical formats. The first, Analysis of Competing Hypotheses, is a technique used when there is a large amount of data to absorb and evaluate.<sup>130</sup> It is perceived most effective with a small team that can critically evaluate the evidence. The approach identifies alternative explanations (hypotheses). All reasonable alternative hypotheses are identified, then the evidence is arrayed against each hypothesis. The process follows these steps: 1) Brainstorming among the team to identify all hypotheses. 2) Each hypothesis and sub-hypotheses are considered as is all the supporting and contrary evidence. The evaluation of all evidence helps disconfirm rather than confirm hypotheses.

Second, the investigation used an A and B team analysis. This approach recognizes that there may be competing and possibly equally strong mind-sets held on an issue that needs to be clarified. The two teams led by the attorneys performed a competitive analyses using legal evidentiary rules supporting each of the two origin hypotheses. The TeamA/TeamB approach is characterized by an analysis and debate phase. The analysis phase develops the best case for each hypothesis. All pertinent information is reviewed that supports the respective hypotheses. Missing information that would buttress either hypothesis is identified. The debate phase allows each team to present and argue their case in support of their hypothesis, challenge the other team's arguments, and rebut the opponent's critique of its case.<sup>131</sup>

The core investigative team was comprised of two attorneys, three research assistants, a China foreign area specialist and two (a medical and veterinarian) epidemiologists. The core group was supported by an outside scientific advisory group consisting of three former U.S. national high-containment laboratory directors, a medical infectious disease physician, medical epidemiologist, two veterinarians, two biosafety experts, and two molecular biologists. Additionally, technical experts were consulted on topics ranging from specific biosafety equipment and processes, vaccine development and production and animal experimentation.

The lines of inquiry followed several topics that included: epidemiology, molecular (genetic) signatures, medical countermeasure development, biosafety, preparedness and response, and political-legislative action. Data collected was limited to open-source, unclassified information. Information was subject to review to evaluate its authenticity, factual content and validity.

Sixty subject matter experts noted authorities or acknowledged spokespersons concerning the issue of COVID-19 origins were interviewed. Some were interviewed multiple times to elicit their insights and sources of information. Additionally, over 600 peer reviewed and public articles were assembled into a bibliography that served as a resource base. Language translations were performed iteratively using automated language translations using GOOGLE TRANSLATE and DEEPL programs. Machine translations were then subject to review by expert translators to verify the content and determine the context of the original text. This reference document was subject to critical technical and analytical review by 24 outside subject matter experts in the fields of epidemiology, medicine, virology, biosafety, intelligence analyses, and China studies.

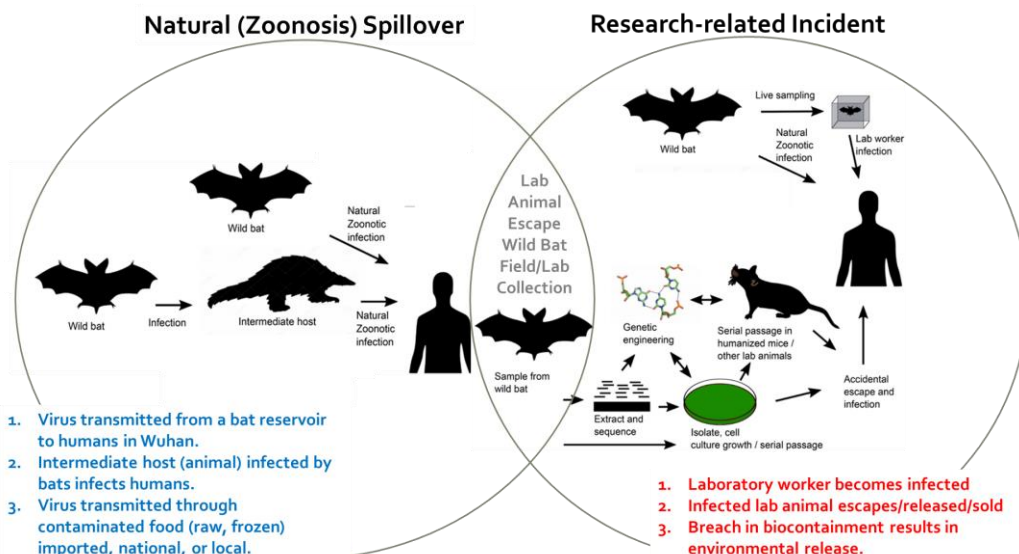

Figure 1. Graphic depiction of two origin hypotheses with attendant sub-hypotheses: Zoonotic & Research-related.

## Study Limitations

From the outset of this investigation, it was evident that access to early epidemiological, molecular (genetics) and supporting human and animal clinical information about the pandemic would be difficult. China delayed release of, withheld and censored relevant scientific information and data. The earliest evidence of this limitation was delays and subsequent challenges obtaining early SARS-CoV-2 genetic sequence data and access to initial viral strains. Epidemiological data and testing for SARS-CoV-2 of human and animal blood samples obtained prior to the start of the pandemic have not been published or shared by China. These samples are essential in evaluating the possible zoonotic origins of SARS-CoV-2. Beginning in March 2020, China began censoring scientific publications related to the origins of the SARS-CoV-2 virus, timing and possible sources of the initial outbreak. China also did not respond to requests for information and limited the investigative efforts by the World Health Organization (WHO).

Congressional committee jurisdictional limitations prevented requesting information from Executive Branch departments and agencies that were not subject to the Senate Health, Education, Labor and Pension (HELP) Committee's oversight. In particular, programs and related grants managed by the Departments of Defense and State. The State Department's U.S. Agency for International Development PREDICT program was of specific interest and relevance. USAID awarded grants to China and the Wuhan Institute of Virology for bat related coronavirus research pertinent to the scope of this investigation.

Finally, despite the HELP Committee's jurisdictional oversight of the Department of Health and Human Services and specifically the National Institute of Allergies and Infectious Diseases (NIAID), requests for information about relevant grants to EcoHealth Alliance and its subgrantee, the Wuhan institute of Virology were often delayed, sometimes incomplete or unfulfilled. Valuable insight concerning NIAID and EcoHealth relevant activities and communications were obtained through public Freedom of Information Act (FOIA) requests by third parties who then made them publicly available.

## Part I.

### Chapter 1: What is SARS-CoV-2 and Where is it From?

#### Introduction

##### 1. Coronaviruses

Viruses are infectious microbes, not free-living cells. Viruses lack the basic capabilities of living cells to generate energy or replicate.<sup>132</sup> They are inert. To replicate and grow they must infect a susceptible living cell and commandeer that cells replication machinery.<sup>133</sup> As a result of this process, viruses are often harmful to the cells they infect.<sup>134</sup> They frequently damage or kill the cell while infecting and replicating. Viruses are made up of genetic material – either RNA or DNA depending on the type of virus – surrounded by a protective protein coat known as a capsid.<sup>135</sup> Some viruses have a lipid envelope that coat the capsid. Once a virus attaches to a host cell, the virus inserts its genetic material. The virus' genetic material is a code that allows it to take over the host cell functions to manufacture viral proteins to make more viruses.<sup>136</sup>

There are 26 different families of viruses that infect humans. Each family have different shapes.<sup>137</sup> The arrangement of protein capsid or its lipid envelope determines the shape of the virus.<sup>138</sup> **Coronaviruses are characterized by an outer layer of proteins shaped like spikes on its envelope that allows the virus to attach to specific receptors on the exterior of host cells.**<sup>139</sup> This shape give it the appearance of a crown, hence its name.

Coronaviruses are a large and diverse family of viruses. They can infect a wide range of birds and mammals.<sup>140</sup> Coronavirus are composed of 30,000 nucleotide pairs and are some of the largest RNA viruses in existence.<sup>141</sup> **They fall into four subcategories – alpha, beta, gamma, and delta.**<sup>142</sup> **The preponderance of important potential pandemic causing coronaviruses are beta coronaviruses.**<sup>143</sup> Beta coronaviruses are divided into five subgenera: sarbecovirus, hibeovirus, nobecovirus, merbecovirus and embecovirus.<sup>144</sup> The 2003 Severe Adult Respiratory Syndrome (SARS) virus, SARS-related viruses that include SARS-CoV-2 are sarbecoviruses.<sup>145</sup> SARS-CoV-2 has not been previously found in humans or animals.<sup>146</sup> Middle East Respiratory Syndrome (MERS) is a merbecovirus.<sup>147</sup> Coronaviruses that cause the common cold are principally alpha-coronaviruses but also include two beta-coronaviruses (OC43 and HKU1).<sup>148</sup>



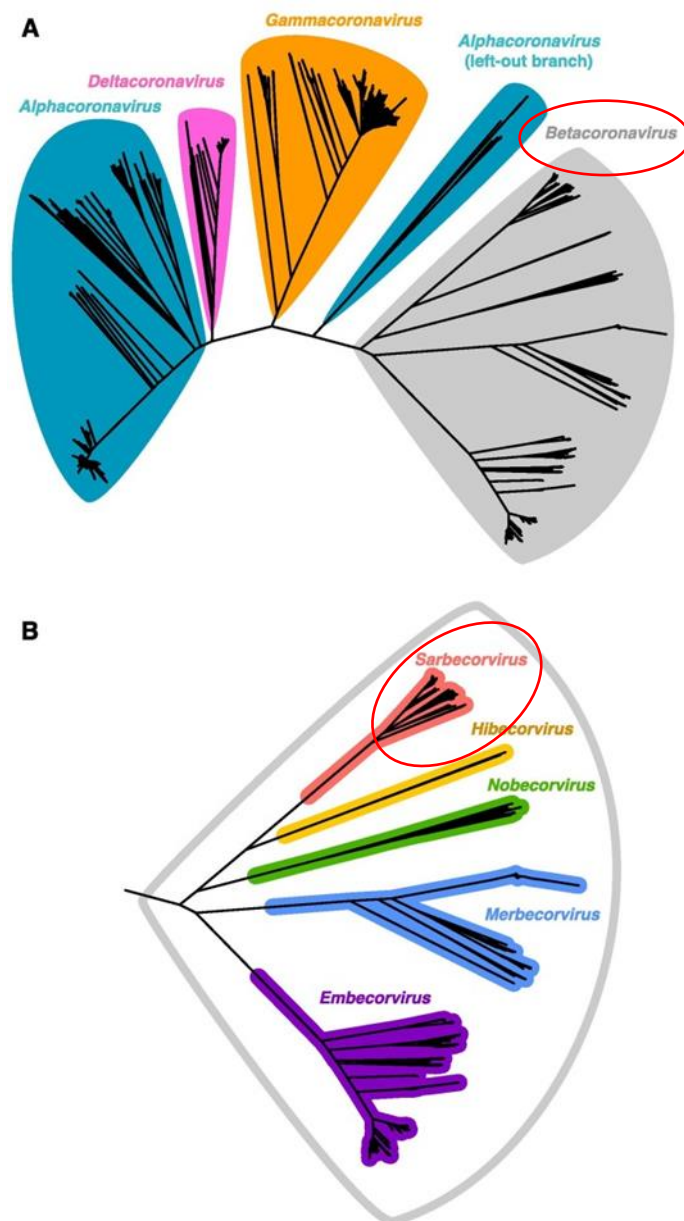

Figure 2. *Phylogenetic tree of coronavirus spike protein sequences. A) Noting genera of coronavirus. B) Subtree of Betacoronavirus, noting subgenera*

Source: Wu, Y., & Zhao, S. (2020). Furin cleavage sites naturally occur in coronaviruses. *Stem cell research*, 50, 102115. Advance online publication. <https://doi.org/10.1016/j.scr.2020.102115>

Coronaviruses, similar to influenza, have demonstrated a keen ability to adapt to new hosts and environments and change or mutate in the face of different selective pressures in nature.<sup>1,149</sup> The emergence of a novel influenza or coronavirus virus present the possibility of human adapted strains that could cause serious outbreaks.<sup>150</sup>

RNA viruses, such as influenza and coronaviruses, evolve rapidly and more frequently than DNA viruses.<sup>151</sup> Adaptability and high mutations rates can make RNA viruses particularly difficult to prevent or treat with vaccines or drug therapies.<sup>152</sup> Evolution happens through two processes, mutation and recombination.<sup>153</sup> Mutations, where a one or more amino acids are switch for another amino acid, can occur during replication.<sup>154</sup> Coronaviruses, like other RNA viruses, have higher mutation rates than DNA viruses because they have a weaker proof-reading mechanism meaning that errors during viral replication are less likely to be corrected.<sup>155</sup> These higher mutation rates during viral replication produces large numbers of offspring variants that are different from the parent strain.<sup>156</sup> The majority of mutations are not beneficial and result in non-viable or unfit virus strains that cannot infect or replicate. However, sometimes mutation may result in adaptive advantages over the parent virus.<sup>157</sup> This can cause a change in infectivity and virulence, the ability to infect new species (increased viral tropism) and allow the virus to evade therapeutics and vaccines.<sup>158</sup>

Modern genetic sequencing technology allows scientists to monitor such mutations. Pathogens circulating in the environment, whether through human or non-human hosts, accumulate genetic mutations over time at a predictable rate (known as viral evolution).<sup>159</sup> This process happens with greater frequency among RNA viruses. This predictable rate of evolution over time allows virologists to date a

<sup>1</sup> Selective pressure: In evolutionary theory, the effect on survival of a species of the sum of all factors, physical and behavioral, inherent and environmental; especially as an inherited trait may marginally effect survival under the influence of these factors. Source: <https://www.genscript.com/biology-glossary/2661/selective-pressure>

strain's emergence and divergence from ancestor strains with a high degree of accuracy – this is the so-called molecular clock, which has been used by virologists since the 1960s.<sup>160</sup>

For example, it was possible to date evolutionary mutation changes in the first waves of the 2009 H1N1 pandemic influenza virus to within a matter of weeks.<sup>161</sup> Because influenza viruses evolve relatively rapidly, they provide a rich chronology of genetic changes for researchers. For example, this molecular clock is important for evaluating the length of time since two circulating viruses evolved from a common ancestor.<sup>162</sup> Relevant to this investigation, it is also a useful tool for estimating how long a virus has been in wide circulation in a population or affected populations.

Another important way viruses mutate is through recombination.<sup>163</sup> This is when different viral strains infect a single host and the host serves as a mixing vessel where genetic material can be exchanged.<sup>164,165</sup> It is an important mechanism of change for coronaviruses.<sup>166</sup> Bats serve as an important mixing vessel since they can simultaneously harbor several different coronavirus species and strains.<sup>167</sup> The frequency of recombination varies among the coronaviruses, including Sarbecoviruses (SARS-beta coronavirus or SARS-related coronaviruses) like SARS-CoV-2.<sup>168</sup>

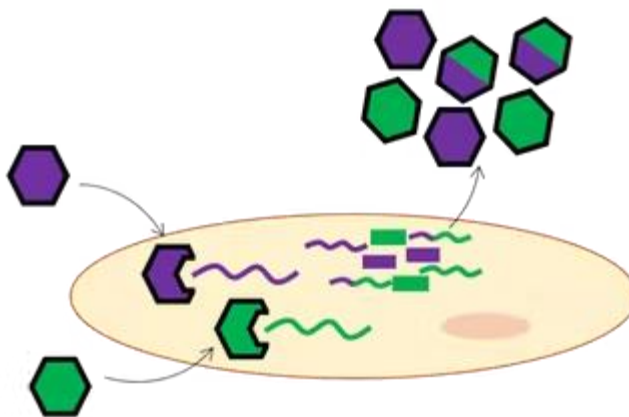

Figure 3. Schematic of viral recombination when two different variants infect the same cell at the same time.

Source: <https://www.weforum.org/agenda/2022/04/omicron-xe-virologist-variants-covid19>

In the case of SARS-related viruses, recombination events are generally associated with mixing of strains within its subgenus. Viruses in different *beta coronavirus* subgenera do not generally exchange RNA with one another.<sup>169</sup> In other words, coronaviruses that are too dissimilar cannot successfully share genetic material. Recombination has important public health implications.<sup>170</sup> Changes that occur because of recombination can impact diagnostic tests. Recombination can also result in rapid escape from naturally acquired immunity. As already documented, SARS-CoV-2 variant strains resulting from recombination showed ability to evade both natural and vaccine induced immunity.<sup>171</sup>

## 2. SARS-CoV-2

### a. Overview

SARS-CoV-2 has a single-stranded RNA genome with approximately 30,000 nucleotides that could code up to 10,000 amino acids.<sup>172</sup> Each group of three nucleotides encodes a particular

amino acid. In addition, SARS-CoV-2’s nucleotides form 29 different proteins, which make up the structure of SARS-CoV-2 or are responsible for carrying out specific viral functions. Four of these proteins, called structural proteins, make up the structure of SARS-CoV-2.

Table 2. Coronavirus Structural Proteins & related function

Structural Protein	Function
Spike Protein (S Protein)	Mediates CoV entry into host cells by first binding to a host receptor (ACE2) and then fusing viral and host membranes
Envelope Protein (E Protein)	Plays a major role in pathogenesis, virus assembly, and release
Membrane Protein (M Protein)	Helps to facilitate the molecular assembly of virus particles and may be involved in pathogenesis
Nucleocapsid Protein (N Protein)	Participates in RNA packaging, facilitates virion assembly, and enhances transcription efficiency

The remaining 25 proteins, called non-structural proteins, control how the virus replicates and avoids host cell immune response, among other functions.<sup>173</sup> Non-structural proteins are further delineated by number of open reading frames (ORFs). The non-structural proteins in ORFs affect the severity (virulence) and nature of infection (pathogenicity) of SARS-CoV-2.<sup>174</sup> For example, ORF 3b, ORF 6, and N proteins have been identified to block interferon, a key component of the human innate immune response.<sup>175</sup>

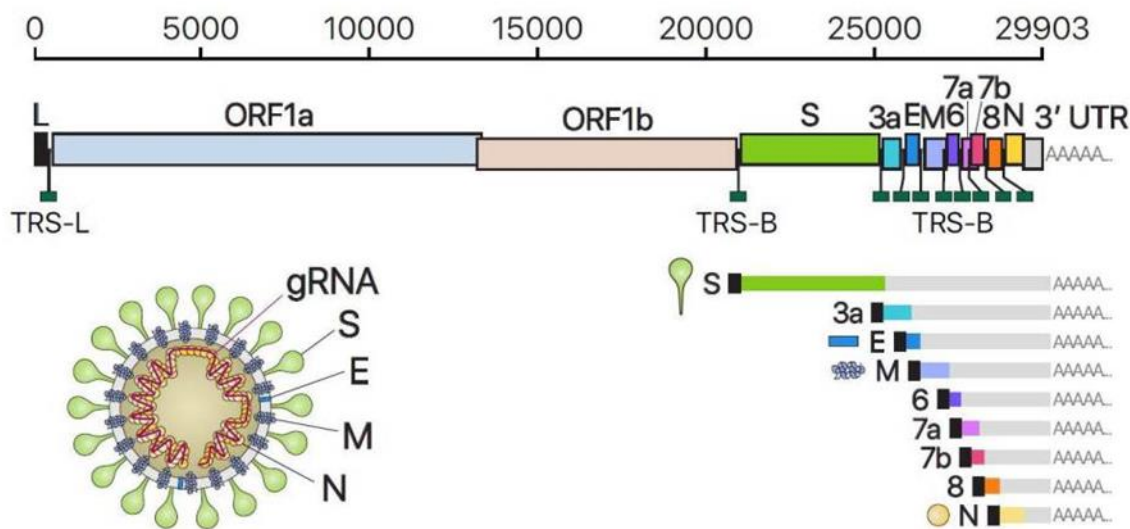
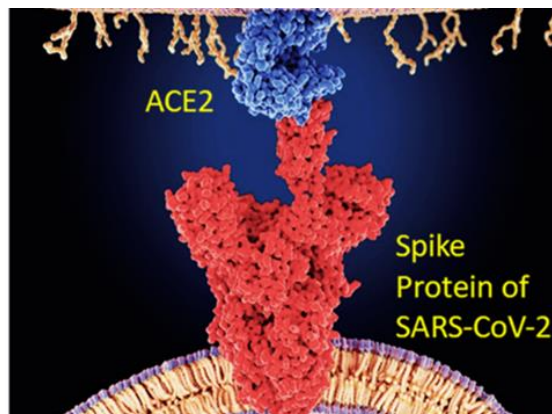

Figure 3. Schematic representation of SARS-CoV-2 genetic makeup and structure  
 Source: <https://sars2cov.wordpress.com/virology/>

## b. SARS-CoV-2's Spike Protein

Like other coronaviruses, the surface of SARS-CoV-2 has “spike” proteins. Spike proteins are the “keys” to how SARS-CoV-2 enters cells. SARS-CoV-2’s spike protein, like those of SARS, binds with the cellular receptor angiotensin converting enzyme 2 (ACE2).<sup>176</sup> As its name suggests, ACE2 is an enzyme that is attached to the cell membrane, the cell’s surface.<sup>177, 178</sup> In humans ACE2 is found in many different types of cells, including lung, heart, blood vessels, kidneys, liver, and the stomach.<sup>179</sup>

ACE2’s normal function is to break down large proteins into smaller segments that can be absorbed by cell.<sup>180 181</sup> These proteins then enter the cell and “instruct” it to perform certain actions that regulate key body functions, such as blood pressure and wound healing.<sup>182,183</sup> ACE2 receptors provide an entry point for proteins, it can also provide an entry point for viruses, who are also seeking to “instruct” the cell to produce copies of the virus.<sup>184</sup>



*Figure 4.* Computer-generated image of the spike protein of a SARS-CoV-2 cell (COVID-19) bonding to the ACE2 protein receptor of a human cell. Through this connection, the viral cells can transfer their DNA and reproduce.

<https://www.uwec.edu/news/news/chemistry-faculty-publish-research-about-covid-19-4298/>

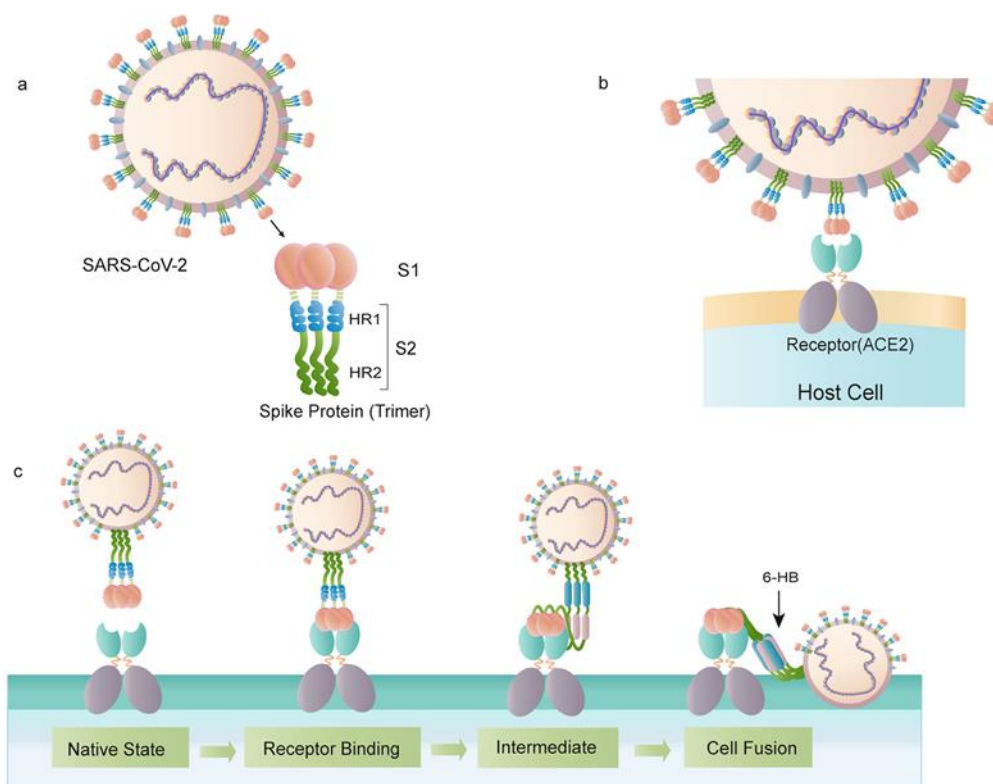

Figure 5. **Schematic of the SARS-CoV-2 Spike protein.** **a.** The schematic structure of the S protein. **b** The S protein binds to the receptor ACE2. **c** The binding and virus–cell fusion process mediated by the S protein. **d** The life cycle of SARS-CoV-2 in host cells. Huang, Y., Yang, C., Xu, Xf. et al. Structural and functional properties of SARS-CoV-2 spike protein: potential antivirus drug development for COVID-19. *Acta Pharmacol Sin* 41, 1141–1149 (2020). Source: <https://doi.org/10.1038/s41401-020-0485>

Structurally, SARS-CoV-2’s spike protein is 1,273 nucleotide base pairs long, representing approximately 4.7% of SARS-CoV-2 genome.<sup>185</sup> The spike protein is divided into two subunits, subunit 1 (S1) and subunit 2 (S2), each has a different function in facilitating cellular entry.<sup>186</sup> Subunit 1 contains a structure called the receptor binding domain (RBD). The RBD attaches to the ACE2 receptors of susceptible host cells to infect the host. Once attached, the S1 acts like an anchor holding the virus to the cell’s membrane. The S2 subunit is responsible for fusing SARS-CoV-2 membrane to the membrane of a soon-to-be-infected host cell.<sup>187</sup> Fusing the membranes together results in the release of SARS-CoV-2 genetic material into the host cell, this material then begins “commandeering” the host cell’s machinery so that it begins replicating the virus.<sup>188</sup>



Figure 6. Schematic of SARS-CoV-2 virus Spike (s) Protein relationship with S1 & S2 subunits.

Source: <https://www.biocat.com/corona-proteins>

The SARS-CoV-2 spike protein, particularly the S1 subunit that is directly next to the RBD, is prone to mutation, particularly as the virus adapts to new hosts.<sup>189</sup> Host adaptation can increase its efficiency binding to human cell receptors and can increase the range of other mammals it can infect.<sup>190</sup>

Experimental *in vitro* and *in vivo* serial passage of SARS coronaviruses can lead to not only adaptation to new species but enhance or lessen virulence.<sup>191,192,193</sup>

Compared to SARS and MERS, SARS-CoV-2 was well adapted for human infection and highly transmissible early in outbreak.<sup>194,195</sup> Over the first year of the pandemic relatively modest genetic change was observed across hundreds of thousands samples from COVID-19 patients.<sup>196</sup> Early SARS-CoV-2 samples were nearly genetically the same, meaning that the virus had not been circulating for a long enough period of time to accumulate significant genetic diversity (viruses accumulate mutations at a predictable rate).<sup>197</sup> These characteristics of SARS-CoV-2 caused one researcher to comment:

[W]hat's been so surprising is just how transmissible SARS-CoV-2 has been from the outset. Usually, viruses that jump to a new host species take some time to acquire adaptations to be as capable as SARS-CoV-2 at spreading, and most never make it past that stage, resulting in dead-end spillovers or localised outbreaks.<sup>198</sup>

Analyses of the evolution of SARS-CoV-2 and its close relatives suggest its affinity for human ACE2 receptors and efficient human-to-human transmission may already have been present in bat viral ancestors.<sup>199,200</sup> Early efforts to identify mutations associated with circulation in an intermediate host species failed to identify animal species that were good candidates to have helped SARS-CoV-2 adapt humans.<sup>201,202</sup> The emergence of more transmissible variants such as Delta and Omicron shows that SARS-CoV-2 continues to adapt to humans.<sup>203</sup> In maintaining fitness for human infection, SARS-CoV-2 is doing so in the face of selective pressure of vaccination and natural infection-acquired immunity.<sup>204</sup>

#### **i. SARS-CoV-2's Furin Cleavage Site**

SARS-CoV-2 is the first SARS-related sarbecovirus found with a furin cleavage site.<sup>205</sup> Furin cleavage sites (FCS) are found in other human pathogens such as avian influenza, HIV and Ebola viruses and are known to increase their infectivity and pathogenesis.<sup>206</sup> SARS-CoV-2's novel furin cleavage site consists of a five amino acid (15 nucleotide) sequence at the junction of the S1 and S2 subunits.<sup>207</sup> This sequence consists of five amino acids: (1) Proline (abbreviated "P"), (2) Arginine ("R"), (3) Arginine, (4) Alanine ("A"), and (5) Arginine, collectively this sequence is abbreviated "PRRAR".<sup>208</sup> Functionally, the FCS is a breakpoint in the spike protein, and allows the enzyme, furin, which is found in many different human cells including lung cells, to split or cleave the spike protein right at the point where the S1 and S2 subunits split.<sup>209</sup> Its location is critical, it ensures the spike protein is cleaved in the correct place for the S2 unit to facilitate cell entry and for the S1 to increase pathogenesis.<sup>210</sup> If the furin cleavage site was located somewhere else in the spike protein, it would not be as effective.<sup>211</sup>

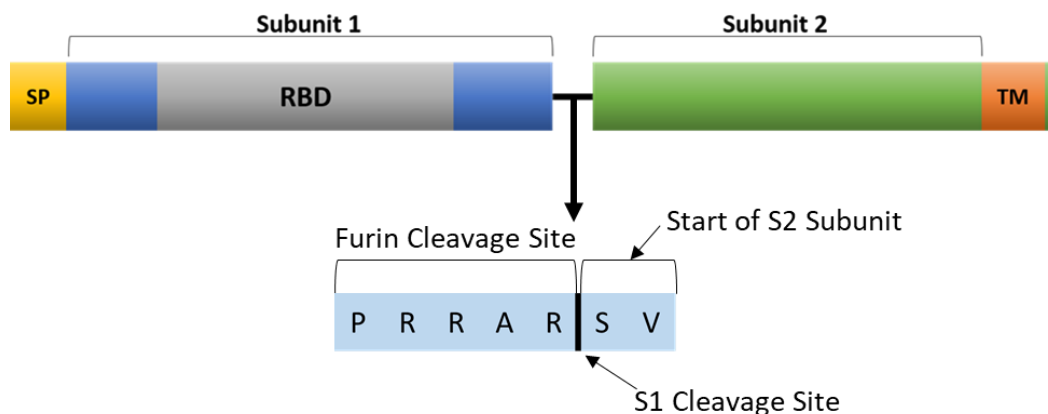

Figure 7. Schematic of SARS-CoV-2 virus Spike (s) Protein relationship with S1 & S2 subunits & Furin Cleavage Site. Source: Adapted from <https://www.biocat.com/corona-proteins>

The FCS in SARS-CoV-2, and its relevance to determining the origins of the virus, has been the subject of scientific and public debate. As a general matter, furin cleavage sites are found in multiple families of coronaviruses including rodent *beta coronaviruses* of the *embecovirus* lineage, avian coronaviruses of the *gamma virus* lineage and certain feline and canine *alphacoronaviruses*.<sup>212</sup> SARS-CoV-2 is the first SARS-related coronavirus found with a furin cleavage site.<sup>213</sup> The most closely related coronaviruses to SARS-CoV-2 is RaTG-13 and BANAL-52 that likely evolved from their common ancestor several decades ago and do not have a FCS.<sup>214,215</sup> The MERS coronavirus virus that has a furin cleavage site is only 50% similar (whole genome) to SARS-Cov-2.<sup>216</sup>

Evidence to date indicate SARS-CoV-2 could originally result from a recombination of sequences pre-existing in *Rhinolophus* bats living in the extensive limestone cave systems of Southeast Asia and South China.<sup>217</sup> It has been suggested that the SARS-CoV-2 furin cleavage site could originate from recombination events with as-yet-undiscovered SARS-CoV-2-related coronaviruses co-circulating in bats.<sup>218,219</sup>

This investigation is aware of a yet unpublished Defense Advance Research Projects Agency (DARPA) sponsored study evaluating the rate of recombination events among coronaviruses. The study evaluated the likelihood of recombination events in relation with the genetic and geographic distance between different beta-coronaviruses. The study found, that although recombination is a common event among members of the coronavirus family, the frequency of the event decays with increasing genetic and geographic distance. Nearly 90% of all recombination events occur between strains that are less than 20% divergent at the nucleotide level in the core genome.

In other words, within SARS-related coronaviruses, recombination involving any part of the genome, including the spike protein, is not totally a random event. Based on historical data, recombination only happens between closely related species. While undersampling of SARS-related coronaviruses cautions against drawing definitive conclusions, none of the coronaviruses with a furin-cleavage site discovered to date have ven a remote likelihood of successfully recombining with SARS-CoV-2 or a closely related virus in close physical proximity. As a result of this analysis, the possibility

that SARS-CoV-2 acquired its furin cleavage site by recombination from other known species of coronavirus are low.

If recombination is unlikely to be the origin of the furin cleavage site, SARS-CoV-2 may have acquired it naturally through a series of very specific mutations at the S1/S2 junction, not seen in other SARS-related viruses identified to date. Several SARS-related viruses similar to SARS-CoV-2 have partial cleavage sites at the S1/S2 junction consisting of three amino acids. Bats are the natural reservoir host for variety of coronaviruses including SARS-CoV-2. Coronaviruses typically infect bat's gastrointestinal tracts, which do not express furin.<sup>220</sup> This has led scientists to believe that it is unlikely that SARS-CoV-2 furin cleavage site is the result of evolutionary pressures in bats. However, SARS-CoV-2's furin cleavage site greatly enhances transmission and pathogenesis in humans. It is also critical for SARS-CoV-2 transmission in ferrets, one of the candidate intermediate host species for SARS-CoV-2, and likely plays an important role in SARS-CoV-2's ability to infect a broad range of mammal species.<sup>221</sup> As a result, it has been speculated that SARS-CoV-2's furin cleavage site evolved as a result of selective pressure mutations either in people or another intermediate host species.<sup>222</sup>

Mutations occur randomly of which there are almost 60,000 nucleic bases in SARS-CoV-2, across the virus's genome. There are approximately 30,000 nucleotides in the genome, which could encode 10,000 amino acids. Mutations can also be insertions or deletions of nucleic acids that may not involve just one amino acid. The probability of mutations resulting in the five amino acid sequence that comprises the furin cleavage site is low, but not impossible. The available evidence suggests that the furin cleavage site represents a remote probability evolutionary event. Recombination represents the more likely evolutionary process but requires that an ancestor of SARS-CoV-2 has a naturally occurring five amino acid insertion at the S1/S2 junction, something to date not seen in any other SARS-related virus.

Experiments conducted in 2012 demonstrated the possibility that a furin cleavage site could be acquired by *in vitro* serial passage. Researchers serially grew a related bovine beta coronavirus (embecovirus) in three different cell types that resulted in a furin cleavage site.<sup>223</sup> In this study, the five amino acid sequence resulted after four to five serial viral passages.

Alternatively, it has been speculated that SARS-CoV-2's furin cleavage site is evidence that the virus has been subjected to genetic manipulation. SARS-CoV-2's furin cleavage site was first reported by French researchers whose findings were published on February 8, 2020.<sup>224</sup> The paper noted the insertion of a furin cleavage site in a *gammacoronavirus* poultry infectious bronchitis virus increased pathogenicity with pronounced nerve cell tropism and neural symptoms. Further, the researchers concluded the furin cleavage site could provide a gain-of-function for efficient spreading in the human population compared to other *beta coronaviruses* like SARS-CoV-1.<sup>225</sup> The plausibility of inserting the five amino acid furin cleavage sequence into a SARS virus was first demonstrated in 2006 and repeated in 2008.<sup>226,227</sup>

Notably, the WIV's SARS-related coronavirus research team, led by Zheng-Li Shi, co-authored a *Nature* paper published on February 3, 2020 analyzing SARS-CoV-2's genome, but made no mention of the furin cleavage site and excluded its amino acid sequence from figures depicting the virus. A preprint article submitted by other researchers from China in late January 2020 identified the SARS-CoV-2 furin cleavage site about the same time of Shi Zhengli's publication. It was submitted for review by the



Chinese Academies of Science and later published in the Chinese Journal of Bioinformatics.<sup>228</sup> The presence of SARS-CoV-2’s furin cleavage site, coupled with the virus emerging in Wuhan, a coronavirus research hub, had led to speculation that it was deliberately inserted:

...furin cleavage sites at the interface of the S1 and S2 domain are not unusual, being found widely in beta coronaviruses in the embeco lineage (which are of rodent origin) as well as in avian-origin gamma coronaviruses and certain feline and canine alphacoronaviruses (with an unknown origin). Furin cleavage sites are also found in certain bat-origin MERS-like merbecoviruses, but not—with the exception of SARS-CoV-2—in the sarbecovirus lineage. **The presence of a furin cleavage motif at the SARS-CoV-2 S1–S2 interface is therefore highly unusual, leading to the smoking gun hypothesis** of manipulation that has recently gained considerable attention as a possible origin of SARS-CoV-2.<sup>229</sup>

## ii. QTQTN Sequence

Impaired or dysfunctional immune responses are a common feature of severe COVID-19 infections.<sup>230</sup> SARS-CoV-2 has a second amino acid sequence immediately “upstream” from the furin cleavage site that may be responsible for some of the virus’s immunomodulating effects, that is the changes in the immune system’s response when infected with SARS-CoV-2.<sup>231</sup> This sequence consists of five amino acids: (1) Glutamine (abbreviated “Q”), (2) Threonine (“T”), (3) Glutamine, (4) Threonine, and (5) Asparagine (“N”), collectively this sequence is abbreviated “QTQTN”.

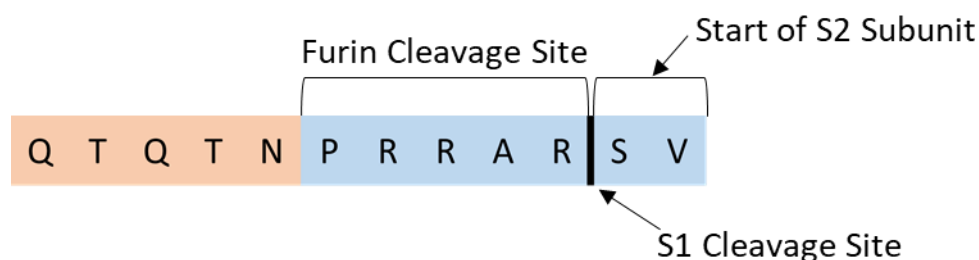

Figure 8. Schematic of SARS-CoV-2 virus relationship of S1 QTQTN sequence with Furin Cleavage Site *Source:* Adapted from <https://www.biocat.com/corona-proteins>

Studies conducted in 2020 and 2021 involving SARS-CoV-2 demonstrate a potential relationship between the furin cleavage site and the QTQTN sequence. The furin cleavage site is essential for infection of human lung cells but does not increase the severity or pathogenesis, of COVID-19 infections.<sup>232</sup> The QTQTN amino acid sequence, which immediately precedes the furin cleavage site, appears to play an important role in the severity of COVID-19 infections.

Researchers have created infectious variants of SARS-CoV-2 virus without the furin cleavage site and deletions of this QTQTN motif. Syrian hamsters infected with SARS-CoV-2 viral variants without the QTQTN sequence have attenuated disease compared to hamsters infected with SARS-CoV-2 with the QTQTN in it.<sup>233</sup> In experiments with hamsters infected with the wild-type SARS-CoV-2 or variant viruses

without the furin cleavage site and part of the QTQTN sequence, the immune responses are different.<sup>234</sup> Hamsters infected with the wild-type virus have higher levels of inflammatory cytokines. Similar variants deleting only the furin cleavage site have similar attenuation in experiments with hamsters and transgenic mice. The loss of the furin cleavage site also result in lower levels of inflammatory mediators.<sup>235</sup>

With respect to origins, several of the viruses most closely related to SARS-CoV-2 also have the QTQTN sequence located in the same section of the spike protein as SARS-CoV-2. This includes at least one virus (RaTG-13) that otherwise has a very different spike protein from SARS-CoV-2. It also includes one of the pangolin associated coronaviruses (GD-pangolin) that shares this same sequence and is identical to SARS-CoV-2 in the 5 critical residues making up the receptor binding domain (RBD)(Figure 9).<sup>236</sup> As will be discussed in greater detail below, these closely related viruses are found in a geographical area spanning southern Yunnan Province, China and northern half of Laos. This suggests that the QTQTN sequence may be an ancestral trait of certain SARS-related viruses.

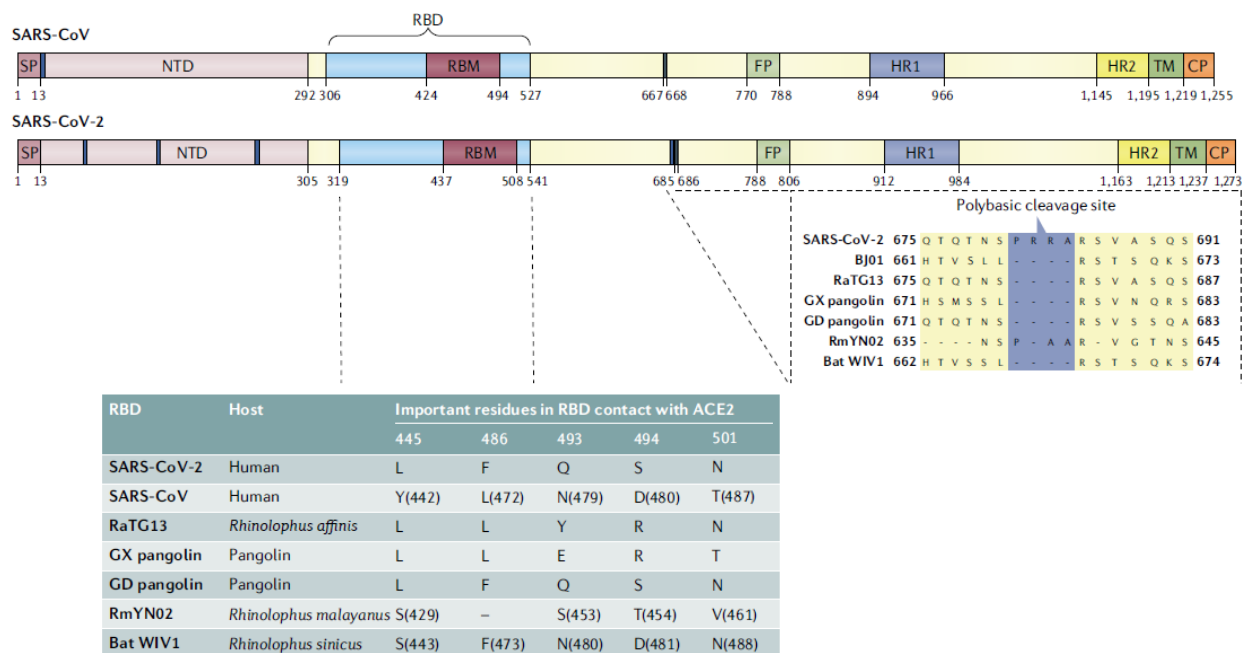

Figure 9. Schematic diagram of the spike (S) protein of severe acute respiratory syndrome coronavirus (SARS-CoV) and SARS-CoV-2. The residue numbers of each region correspond to their positions in the S proteins of SARS-CoV and SARS-CoV-2. The dark blue blocks represent insertions in the S protein. The insertions at amino acids 675–691 of the SARS-CoV-2 S protein are shown in an enlargement at the bottom right and aligned with those of other coronaviruses in the same region. The five critical residues in the RBD of SARS-CoV-2 and other viruses are shown in the RBD labeled table. Source: Hu, B., Guo, H., Zhou, P., & Shi, Z. L. (2021). Characteristics of SARS-CoV-2 and COVID-19. Nature reviews. Microbiology, 19(3), 141–154. <https://doi.org/10.1038/s41579-020-00459-7>

### iii. Integrin Receptor

In February 2020, Swiss researchers identified an integrin receptor in SARS-CoV-2’s receptor-binding-domain (RBD) located approximately 39 amino acids “upstream” of the sequence responsible for binding to the ACE2 receptor.<sup>237</sup> Integrins are a large family of cellular receptors.<sup>238</sup> Distinct from the ACE2 receptors found in SARS-related viruses, integrins are found in a diverse set of clot-forming,

inflammatory, neoplastic (cancer) and infectious diseases.<sup>239</sup> In viral infections, integrins are involved in a variety of host cellular functions related to infectivity and virulence.<sup>240</sup>

A number of viruses bind to integrin receptors as a means of infecting human cells.<sup>241</sup> The sequence of this particular integrin is only three amino acids long consisting of: (1) Arginine (“R”), (2) Glycine (“G”), and (3) Aspartic Acid (“D”) collectively “RGD” (Figure 10). The RGD sequence is only found in SARS-CoV-2. In the Swiss study, this sequence was not found in 30 related coronavirus spike proteins and 155 SARS sequences examined.<sup>242</sup> Its presence represents a single nucleic acid substitution of the genetic sequence found in SARS resulting in the amino acid Arginine rather than Lysine. The presence of this integrin represents another novel feature of SARS-CoV-2 representing an alternative, independent cellular binding and viral entry route.<sup>243,244</sup>

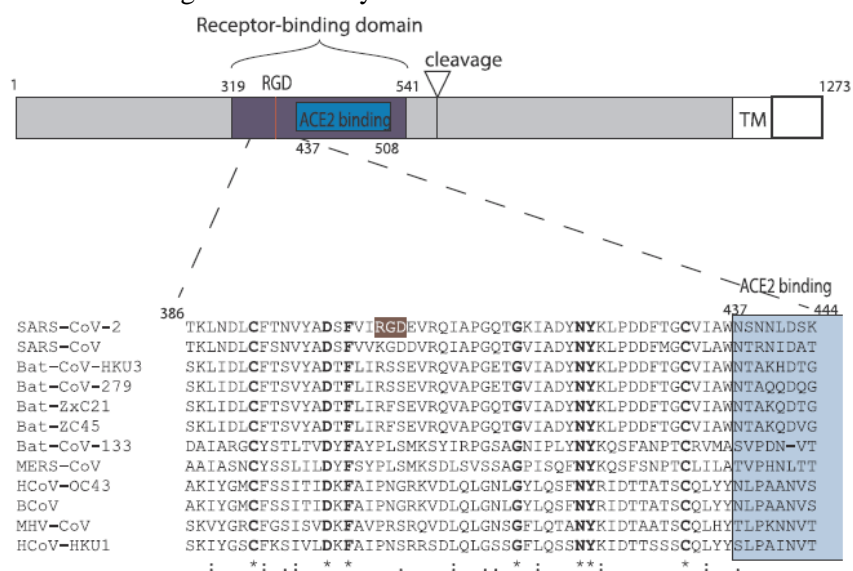

Figure 10. Schematic representation of SARS-CoV-2 S-protein with a focus on the receptor-binding domain. The sequences of 12 beta coronaviruses were aligned using MAFFT (Kato et al., 2019). The receptor-binding domain and the ACE2 receptor-binding region are colored in blue and light blue, respectively. The RGD motif of SARS-CoV-2 is highlighted in color. Numbers refer to the SARS-CoV-2 spike protein sequence. Source: Sigrist, C. J., Bridge, A., & Le Mercier, P. (2020). A potential role for integrins in host cell entry by SARS-CoV-2. *Antiviral research*, 177, 104759. <https://doi.org/10.1016/j.antiviral.2020.104759>

The RGD motif is not found in strains identified as RaTG-13 nor GD Pangolin.<sup>245,246</sup> It is, however, found in a number of other SARS-related coronaviruses, including Rco319, BANAL-52, BANAL-236, RshSTT182, Rs7924, RmYN08, RsYN04, and several others. Therefore, this motif is not an unusual feature unique to SARS-CoV-2, unlike the furin cleavage site. Its clinical implications are significant.

Researchers from China and Ireland noted that the SARS-CoV-2 integrin resulted in higher human cell affinity compared with SARS.<sup>247,248</sup> Their studies showed that the virus recognized integrin receptors on human lung cells which accelerated the infection process and played an important role in promoting rapid transmission.<sup>249</sup> The RGD integrin also attaches to blood vessels and platelets causing clot formation.<sup>250</sup> Blood clots are a distinguishing pathological feature of severe SARS-CoV-2 infection that include strokes, myocardial infarctions (heart attacks), pulmonary and venous emboli. Autopsies of COVID-19 patients showed unique clotting features in small blood vessels of the heart, lungs, kidney and

liver.<sup>251</sup> These findings indicate that SARS-CoV-2 infection results in both activation of platelets and the uncontrolled growth of new small blood vessels, called angiogenesis.

SARS-CoV-2 has more adverse effects on the cardiovascular system than other coronaviruses and abnormal clotting distinct from other viral illnesses.<sup>252,253,254</sup> The presence of the integrin receptor in SARS-CoV-2 not only increases its virulence, causing COVID-19's unique clinical pathological features, but results in higher transmissibility. **With respect to origins, the presence of an integrin receptor is a single nucleic acid substitution resulting in a novel genetic finding in coronaviruses found in nature with profound clinical and public health implications.**

### 3. Where is SARS-CoV-2 From?

**It is highly unlikely that SARS-CoV-2 is a completely artificial creation. Even if the COVID-19 pandemic is the result of a research-related incident involving a chimeric virus or gain of function experiment at the WIV, the vast majority of SARS-CoV-2's genome comes from nature.** At a minimum, researchers would have likely started with fragments from naturally occurring viruses and combined those fragments with a virus whose whole genome they had successfully grown.<sup>255</sup> Moreover, WIV scientists' research focused on SARS-related viruses or fragments of SARS-related viruses that they collected which appeared to have the potential to infect humans and needed only small changes to approximately 1-2% of a virus's genome.<sup>256</sup> **Therefore, whether the COVID-19 pandemic is the result of the natural zoonotic spillover of SARS-CoV-2 or due to a research-related incident, SARS-CoV-2 or a closely related progenitor virus resides somewhere in nature.**

The most likely candidate viral reservoirs are one or more species of horseshoe bats (*Rhinolophus* bats) living in the extensive limestone cave systems of Southeast Asia and South China. Bats are the second largest order of mammals, with over 1,230 species.<sup>257</sup> They serve as the endemic animal reservoir to many viruses. Like birds, another viral reservoir, bat species have “many shared, convergent features, such as small body size, high population densities, close social interaction, spatial mobility, and the ability to colonize anthropogenic environments” which allow them “to act as viral reservoirs and to transmit viruses to other vertebrates, including humans.”<sup>258</sup> Coronaviruses account for over 30% of the world's viruses. Bats harbor the largest diversity of coronaviruses among mammals, including *beta coronaviruses* of which SARS-CoV-2 belongs.<sup>259</sup> Bats serve as the endemic animal reservoirs for the progenitor viruses of SARS and MERS.<sup>260,261</sup> The horseshoe bats species most likely to serve as the reservoir of SARS-CoV-2 include: the Intermediate Horseshoe Bat (*Rhinolophus affinis*), the Malayan Horseshoe Bat (*Rhinolophus malayanus*), the Least Horseshoe Bat (*Rhinolophus pusillus*), and the Marshall's Horesebat (*Rhinolophus marshalli*).

Moreover, the coronaviruses discovered to date that are most closely related to SARS-CoV-2 are all bat coronaviruses discovered in southern China and Southeast Asia, including Laos, Thailand and Cambodia.<sup>262</sup> Notably, the progenitor virus for SARS and other viruses closely related to SARS were discovered in southern China. Bat population density and species variety appear to play an important role in shaping the evolution of SARS-related coronaviruses.

Within this region of Southeast Asia and Southern China, “very similar SARS-CoV-2-like viruses are shared by different bat species, suggesting a possible circulation of viruses between different species living sympatrically in the same caves.”<sup>263</sup> Researchers believe that the cohabitation of multiple bat species in the same caves increases likelihood of recombination events as multiple closely related, but distinct viruses can infect a single bat giving viruses the opportunity to exchange genetic material.<sup>264</sup> “Recombination has been associated with the expansion of viral host ranges, the emergence of new viruses,” as well as changes in transmissibility and increases in virulence and pathogenesis, among other characteristics.<sup>265</sup>

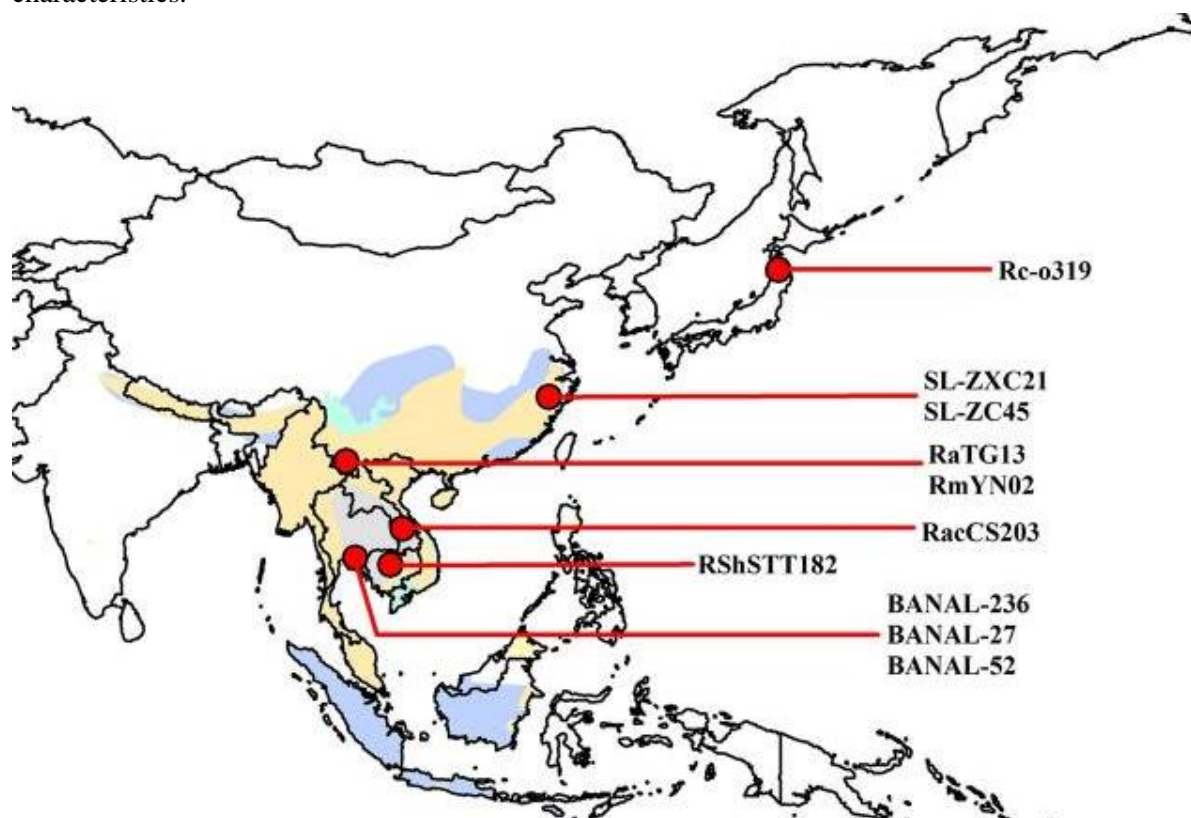

Figure 11. Figure 9: Distribution of bats species from which SARS-CoV-2-like viruses have been found. Distribution of *R. pusillus* (orange) *R. affinis* (blue), and *R. malayanus* (green). Source: Islam, A., Ferdous, J., Sayeed, M. A., Islam, S., Kaiser Rahman, M., Abedin, J., Saha, O., Hassan, M. M., & Shirin, T. (2021). Spatial epidemiology and genetic diversity of SARS-CoV-2 and related coronaviruses in domestic and wild animals. *PloS one*, 16(12), e0260635. <https://doi.org/10.1371/journal.pone.0260635>

Geography, flight patterns, and the migration range of infected bat populations also appears to impact where specific clusters of similar SARS-related viruses are found. As a result, closely related viruses should cluster together geographically. Moreover, as bats migrate and travel to different cave systems, the viruses they are infected with are presented with new opportunities to infect other bats that they come into close contact with. This in turn presents new opportunities for mutation and recombination events which can result in a new virus with different traits that is less closely related to its ancestors.

In early 2019, researchers from the WIV published a paper analyzing how bat migration patterns and flight range restrictions impacted the transmission of SARS-related viruses within China.<sup>266</sup> They found that SARS-related viruses most closely related to SARS were found in the Southern Chinese provinces of Yunnan, Guangxi, and Guizhou, which are adjacent to Laos, Cambodia, and Vietnam. Their

findings suggests that the geographical range of SARS-related viruses is impacted by the range of infected bat populations.<sup>2</sup>

This appears to be the case with the closest known relatives to SARS-CoV-2, all of which appear to have descended from a common ancestor shared with SARS-CoV-2 around 20 to 70 years ago.<sup>267</sup> The closest related bat coronavirus to SARS-CoV-2, as measured by highest average genetic similarity is BANAL 52 which is approximately 96.8% similar to SARS-CoV-2 at the whole genome level.<sup>268</sup> It was discovered in 2021 in Laos by a joint Laotian-French team along with two other closely related SARS-related coronaviruses, BANAL 103 and BANAL 236 which are both 90% similar to SARS-CoV-2 at the whole genome level.<sup>269</sup> The three BANAL series viruses are also closely related to SARS-CoV-2 when measured by the similarity of sections of their spike proteins.<sup>270</sup> The RBDs of BANAL-52 and BANAL-103 are 97.4% similar to the RBD of SARS-CoV-2. The RBD of BANAL-236 is 96.9% like that of SARS-CoV-2.<sup>271</sup>

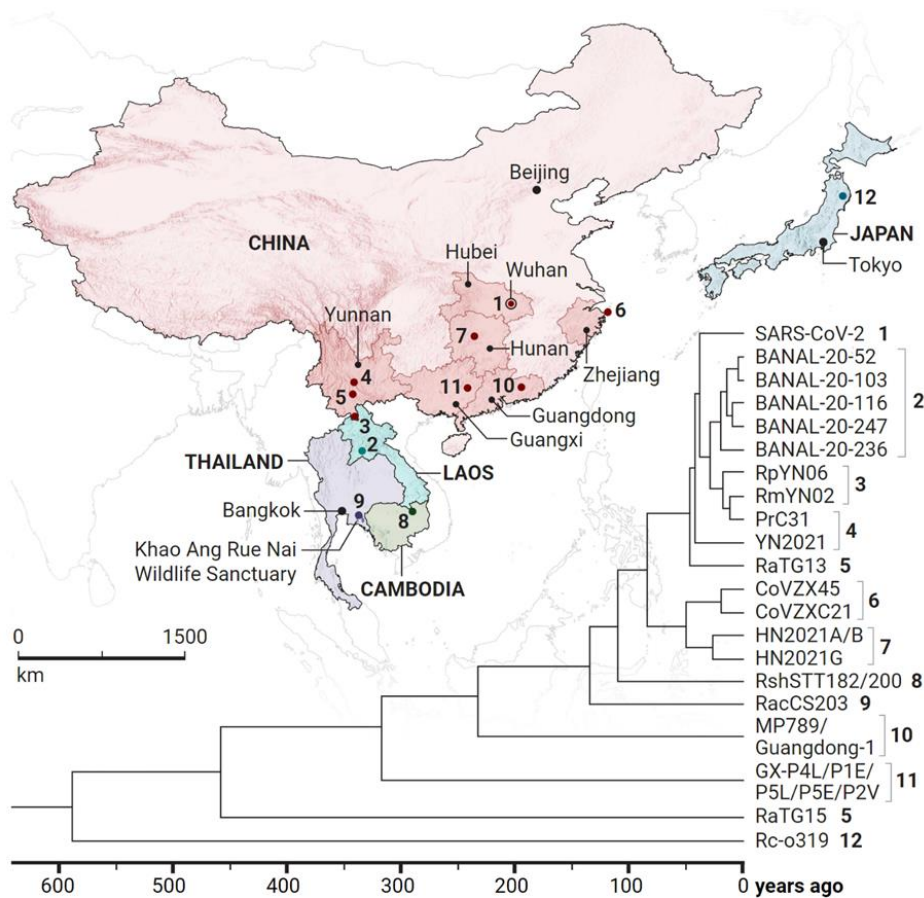

Figure 12. Geographic distribution of SARS-related viruses related to SARS-CoV-2 in China and Southeast Asia.

Source: Lytras S., Robertson D.L. University of Glasgow Centre for Virology Source:

<https://www.gla.ac.uk/research/az/cvr/impactopendata/impact/covid-19researchresponse/sars-cov-2explained/wheredidsars-cov-2comefrom/>

<sup>2</sup> The importance of geographic restrictions on the location of closely related SARSr-CoV is corroborated by the successful search for the likely natural reservoir of SARS. In 2013, WIV researchers found a virus 95.6% similar to SARS in discovery of SARS-related virus, WIV1, in a cave in Yunnan Province. In 2017, WIV researchers discovered, through additional sampling, that the same cave actually contained “all of the genetic building blocks” necessary for SARS. <https://www.ncbi.nlm.nih.gov/pmc/articles/PMC5708621/>.

As a result of this similarity, all three BANAL series viruses also use ACE2 as an entry receptor. In fact, scientists have shown through experiments that the RBD of BANAL-52 binds with greater affinity to human ACE2 than SARS-CoV-2. This suggests that the BANAL series may be able to directly infect humans. However, experiments conducted to date suggest that BANAL viruses mostly replicate in human intestinal cells, rather than respiratory cells.<sup>272</sup> The BANAL series is also more divergent from SARS-CoV-2 in the S2 subunit of the spike protein. Critically, none of the BANAL series viruses have a furin cleavage site at the S1/S2 junction of their spike proteins.

Two BANAL viruses less closely related to SARS-CoV-2, BANAL-116 and BANAL-247, have a partial furin cleavage site at the S1/S2 junction, which is the same location where SARS-CoV-2's furin cleavage site is located.<sup>273</sup> The partial furin cleavage site of BANAL-116 and BANAL-247 consists of three amino acids instead of the four amino acid insertion for SARS-CoV-2. Attempts to experimentally generate a furin cleavage site in BANAL-236 through 6 serial passages in humanized mice and human intestinal cells failed.<sup>274</sup> These experiments were conducted in animal biosafety level 3 (ABSL-3) conditions.<sup>275</sup>

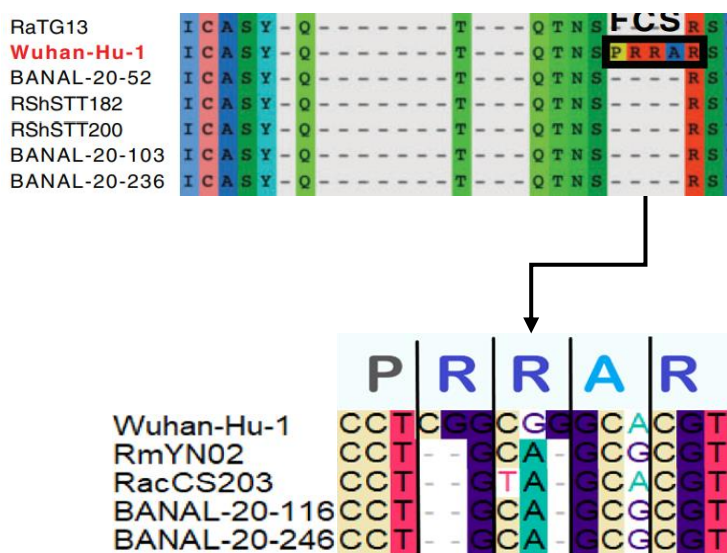

Figure 13. Amino acid alignments of subsets of SARSr-CoV genomes (nucleotides). The subsets were created by excluding select entries to illustrate how sensitive alignments in the spike S1/S2 region. Source: <https://pubmed.ncbi.nlm.nih.gov/34788836/#&gid=article-figures&pid=fig-2-uid-1> and Alternative alignments of the SARS-CoV-2 reference sequence (Wuhan-Hu-1) with RmYN02 at the furin site region. Source: <https://virological.org/t/the-sarbecovirus-origin-of-sars-cov-2-s-furin-cleavage-site/536>

After the BANAL group of viruses, the next most closely related virus to SARS-CoV-2, as measured by highest average genetic similarity, is the bat SARS-related strain RaTG-13.<sup>276</sup> It was first isolated in bats and designated as BtCoV4991 in July 2013.<sup>277</sup> RaTG-13 is the most closely related virus to SARS-CoV-2 known to be in the WIV's possession prior to the COVID-19 pandemic. With respect to the origins of SARS-CoV-2, RaTG-13 has been a source of controversy. Regardless of the circumstances surrounding its discovery, RaTG-13 is approximately 96.1% similar across the entire viral genome. This 4% difference represents “a significant evolutionary gap” between RaTG-13 and SARS-CoV-2 that

reflects between 20-50 years of evolutionary distance.”<sup>278</sup> RaTG-13 is most divergent from SARS-CoV-2 in the S gene that

encodes the spike protein, being only 93.1% similar. The S protein determines the tropism and pathogenicity of the virus, enables the virus to bind to cells and is prone to frequent viral recombination events.<sup>279</sup> In contrast to the three BANAL viruses, due to differences in its spike protein, RaTG-13’s binding affinity with human angiotensin converting enzyme 2 (hACE2) is approximately 1,000 times lower than SARS-CoV-2, leading to the conclusion that RaTG-13 is unable to infect humans.<sup>280,281</sup>

There are a few other closely related coronaviruses that, due to genomic recombination events common in coronaviruses, may share a more recent common ancestor with SARS-CoV-2 than RaTG-13. These include the bat coronaviruses RmYN02, RpYN06, RacCS203, and PrC31.<sup>282</sup> These are, however, less similar to SARS-CoV-2 across the entire genome. All these viruses were found in southern China and sequenced since the start of the COVID-19 pandemic.<sup>283</sup> Of note, RmYN02 and RacCS203 contains the same three amino acid insertion at the junction site of the S1 and S2 sub-units as BANAL-116 and BANAL-247.<sup>284</sup> RmYN02 was collected from a part of southern Yunnan Province approximately 261 miles north of the cave where the BANAL series viruses were collected.

While none of the viruses closely related to SARS-CoV-2 have a furin cleavage site, several have the same QTQNS sequence at the same location as the one found in SARS-CoV-2.<sup>285</sup> These viruses include: RaTG-13, BANAL-52, BANAL-103, BANAL-236, RShSTT182, and RShSTT200.<sup>286</sup> This group of closely related viruses, all found in same geographical area running from Yunnan Province to Cambodia, share this specific sequence of amino acids in the same location within an otherwise highly mutation prone section of their spike proteins, suggests that it is derived from a common ancestor virus. By contrast, none of the SARS-related viruses similar to SARS-CoV-2 that contain partial furin cleavage sites, BANAL-116, BANAL-247, RaCS203, or RmYN02, contains the QTQNS sequence.<sup>287</sup> **To date, only SARS-CoV-2 has both the QTQNS sequence and a complete, and functional furin cleavage site.**



## Chapter 2: Chronology of the Early SARS-CoV-2 Outbreak

### Introduction

Exactly when SARS-CoV-2 first emerged in humans is unknown. The first publicly reported COVID-19 cases in China have symptom onset dates in early-December 2019.<sup>288</sup> There is a broad scientific consensus that these known early cases are unlikely to represent the first or index COVID-19 case, for reasons outlined in the WHO-China Joint Report:

[T]he earliest recognized cases of COVID-19 in Wuhan were thought to have occurred in early-December 2019.... As SARS-CoV-2 infection may, however, be asymptomatic or cause only mild illness in many individuals, it is likely that the others were infected at the time of recognition of the early cases and that transmission could have been occurring in the community before this point.<sup>289</sup>

If SARS-CoV-2 spilled over in humans through zoonosis, it is unlikely that the primary COVID-19 case will ever be identified and it is unlikely that the world will ever know exactly when SARS-CoV-2 first infected humans.

This section summarizes the available evidence indicating that SARS-CoV-2 most likely emerged between mid-October and early to mid-November, 2019 with sustained human-to-human transmission of the virus occurring within weeks of the first human cases if not immediately after its introduction into the human population. This timeframe is consistent with the Director of National Intelligence's assessment and most, but not all, epidemiological modeling.<sup>290</sup>

In addition to modeling and medical countermeasures, there is a substantial body of reporting suggesting there were COVID-19 infections in November 2019. This evidence includes reporting on Wuhan medical practitioners' experiences, firsthand accounts from westerners living in Wuhan, leaked PRC government documents, declassified U.S. intelligence assessments, and public statements by prominent western virologists recounting discussions with Chinese counterparts regarding a new disease outbreak.

Studies published by epidemiologists in China using data from its National Health Commission indicate a large increase in influenza like illness (ILI) occurring in the month of November 2019 over historic norms. The increase in ILI disease occurred before the recognition of pneumonia patients later identified as the earliest cases of COVID-19. As suggested by these researchers, these ILI cases may have been the earliest indicator of community transmission of SARS-CoV-2.

Finally, this investigation reviewed the PRC's early COVID-19 vaccine development program led by its National Health Commission (NHC). Based on the precedent of Operation Warp Speed and available information on the dates of vaccine development milestones achieved by NHC's vaccine teams, it appears that the PRC started its COVID-19 vaccine development program no later than December 2019.

### 1. Emergence: October-November 2019

### a. Epidemiological & Phylogenetic Modeling Suggests Early-October to Mid-November 2019 Emergence

Several epidemiological and phylogenetic models examined the earliest known genetic sequences of SARS-CoV-2 to decipher the time to their most recent common ancestor (tMRCA). Knowing the tMRCA allows researchers to estimate how long SARS-CoV-2 may have circulated before it was first identified. These analyses, however, suffer from the same limitations as other early epidemiological analyses as they are dependent solely on available data, which is incomplete. Nevertheless, using this approach, these studies have found that the most likely period of SARS-CoV-2 emergence in humans is from early/mid-October to mid-November 2019.<sup>291</sup>

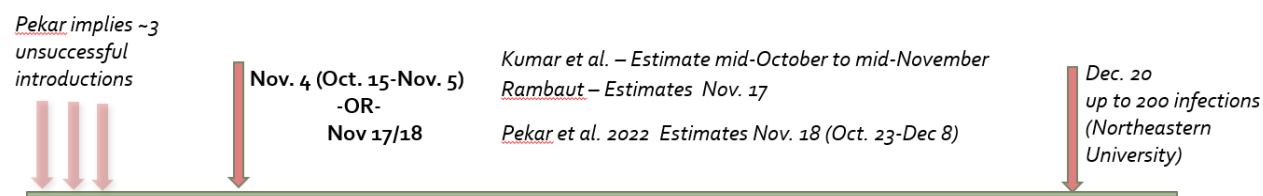

Figure 14. Compilation of published epidemiological and molecular aging models estimating the initial emergence of SARS-CoV-2 based on available epidemiological & genetic data of COVID-19 cases. Note: ~3 unsuccessful introductions denote 3 human infections that did not subsequently propagate to produce additional cases.

Sources: Kumar, S., Tao, Q., Weaver, S., Sanderford, M., Caraballo-Ortiz, M. A., Sharma, S., Pond, S. L. K., & Miura, S. (2021). An Evolutionary Portrait of the Progenitor SARS-CoV-2 and Its Dominant Offshoots in COVID-19 Pandemic. *Molecular biology and evolution*, 38(8), 3046–3059. <https://doi.org/10.1093/molbev/msab118>; Holmes, E. C., Goldstein, S. A., Rasmussen, A. L., Robertson, D. L., Crits-Christoph, A., Wertheim, J. O., Anthony, S. J., Barclay, W. S., Boni, M. F., Doherty, P. C., Farrar, J., Geoghegan, J. L., Jiang, X., Leibowitz, J. L., Neil, S. J. D., Skern, T., Weiss, S. R., Worobey, M., Andersen, K. G., Garry, R. F., ... Rambaut, A. (2021). The origins of SARS-CoV-2: A critical review. *Cell*, 184(19), 4848–4856. <https://doi.org/10.1016/j.cell.2021.08.017>; Pekar, J. E., Magee, A., Parker, E., Moshiri, N., Izhikevich, K., Havens, J. L., Gangavarapu, K., Malpica Serrano, L. M., Crits-Christoph, A., Matteson, N. L., Zeller, M., Levy, J. I., Wang, J. C., Hughes, S., Lee, J., Park, H., Park, M. S., Ching Zi Yan, K., Lin, R. T. P., Mat Isa, M. N., ... Wertheim, J. O. (2022). The molecular epidemiology of multiple zoonotic origins of SARS-CoV-2. *Science (New York, N.Y.)*, 377(6609), 960–966. <https://doi.org/10.1126/science.abp8337>

Combining these genetic estimates with retrospective epidemiological modeling reinforces that the likely first case(s) occurred sometime in mid-October or early to mid-November 2019. These models and analyses attempt to estimate the date of the emergence of the most recent common ancestor of human SARS-CoV-2. Some of these analyses suggest that there could have been instances of failed human-to-human transmission before the virus finally began to spread widely.<sup>292</sup>

One epidemiological model describes the likely emergence timeline of three distinct spillover events based on risk and event simulations: 1) a natural zoonotic spillover, 2) an outbreak caused by an infected laboratory animal, and 3) an outbreak originating from a researcher infected in a laboratory.<sup>293</sup> This model generally aligns with other estimates of an October-November zoonotic event. This model, however, suggests earlier dates of emergence for discrete scenarios involving the escape of a laboratory animal or an infected researcher that would result in the observed COVID-19 outbreak epidemiology. Using this data, the model shows that an initial emergence earlier than October 2019 is possible.<sup>294</sup>

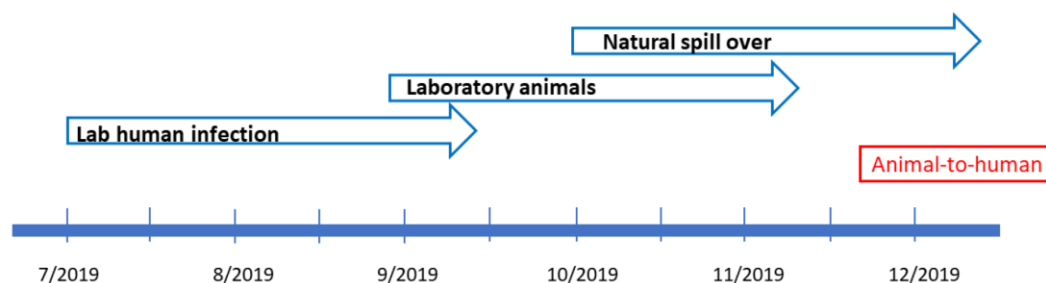

Figure 15. Timeline for the index case with respect to different virus-origin potentials. Note that multiple events could have occurred in the laboratories; they are not mutually exclusive. The red “animal-to-human” box denotes existing clinical evidence of earliest reported cases. Source: [https://www.evaluee-innovation.net/CenterORMedicine/Papers/2021\\_SARS\\_Origin\\_EvaLee.pdf](https://www.evaluee-innovation.net/CenterORMedicine/Papers/2021_SARS_Origin_EvaLee.pdf)

### b. Wuhan ILI Surveillance Sees Uptick in Cases in the Last Week of November 2019

Wuhan influenza like-illness (ILI) surveillance data presented to the WHO-China joint team showed that the level of illness in Wuhan was consistent with the “previous three years” until “a steep increase is seen in 2019, which rapidly exceeds the trend of the previous three years.” This increase begins in Week 48 (November 24-30, 2019) and largely contributed by a sharp rise in ILI in children. This follows an initial spike in adult ILI incidence two weeks earlier.<sup>295</sup>

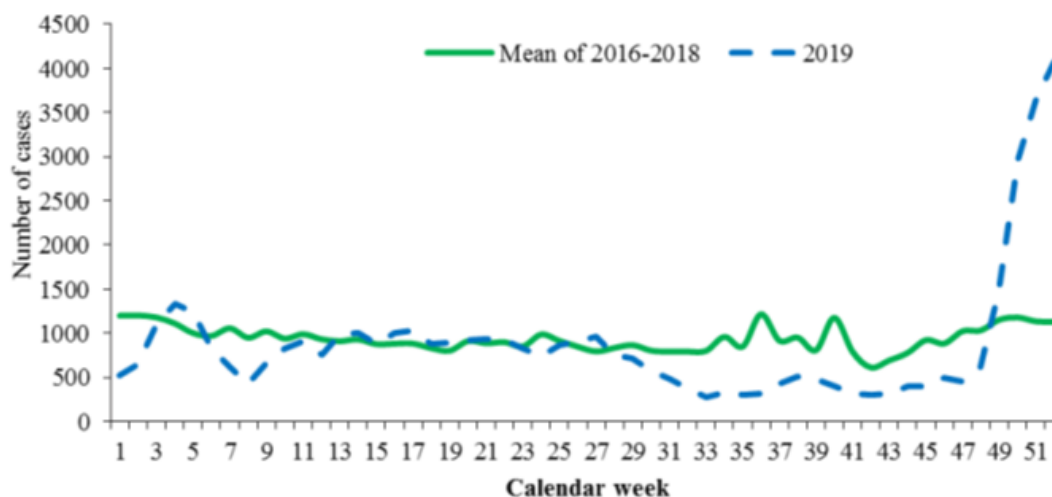

Figure 16. Weekly distribution of previous three years’ mean value of ILI% compared to 2019 in Wuhan. WHO-convened global study of origins of SARS-CoV-2: China Part Source: <https://www.who.int/publications/i/item/who-convened-global-study-of-origins-of-sars-cov-2-china-part>

During the pandemic, SARS-CoV-2 had an estimated incubation period of between 6.5 days with a range of 2-14 days meaning that if the Week 48 surge is attributable to SARS-CoV-2, the cases reflected in ILI surveillance were likely infected in Week 47 (November 17-24) or earlier. This mid-November 2019 timeframe is consistent with the date range for the emergence of SARS-CoV-2 provided by the epidemiological and genomic modeling detailed above.

### c. Spike in Lab Test Negative ILI in Wuhan in mid-November 2019

ILI data provided by China to the WHO as part of their joint 2021 investigation showed an increase of Wuhan adult ILI cases over historical records during week 46 (November 11-17, 2019) (Figure 15). These cases corresponded to simultaneous influenza negative laboratory tests of ILI adult cases that same week. (Figure 18)<sup>296</sup> This epidemiological finding was identified by the Scientific Advisory Group for the Origins of Novel Pathogens (SAGO) as an “unexplained increase in ILI in adults from Wuhan.”<sup>297</sup>

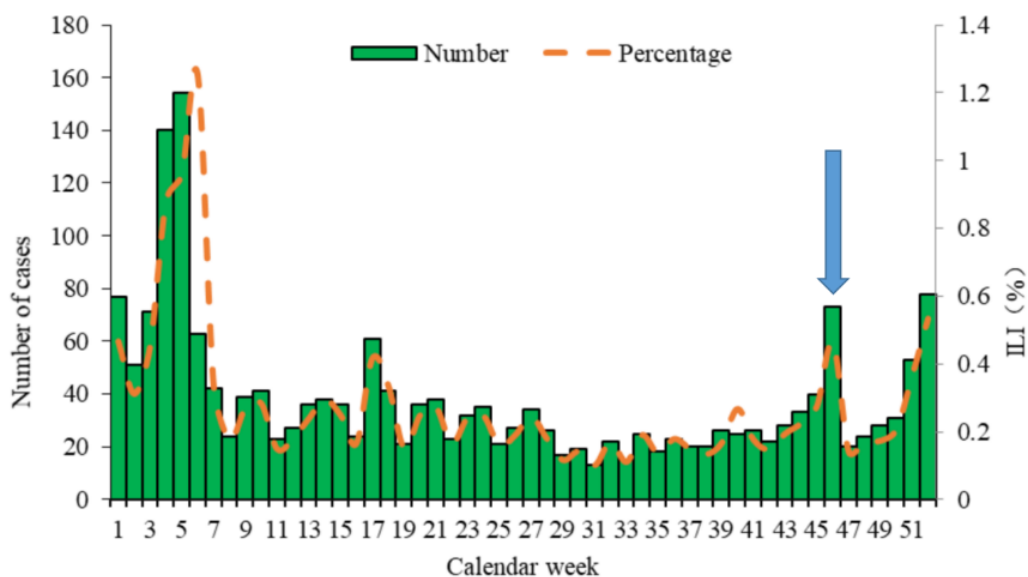

Figure 17. Weekly number of ILI cases in adults in the sentinel surveillance in Wuhan in 2019 (and percentage of outpatient visits categorized as ILI, [ILI %]). Source: WHO-convened global study of origins of SARS-CoV-2: China Part. www.who.int. Published March 30, 2021. <https://www.who.int/publications/i/item/who-convened-global-study-of-origins-of-sars-cov-2-china-part>

A 2022 published study analyzed data from existing WHO global influenza surveillance networks early in the COVID-19 pandemic. Their analysis identified outliers in influenza-negative influenza-like illness (ILI) that served as potential early indicator of COVID-19 community transmission.<sup>298</sup> Their analysis of 28 countries’ ILI surveillance data over a four-year period (2015-2019) identified ILI outlier peaks in 16 countries that occurred on average 13.3 weeks before the occurrence of peak COVID-19 incidence in those countries. The timing of this early ILI peak was associated with influenza-negative tests in Wuhan comports with the approximate time span where this outlier could represent the initial emergence of SARS-CoV-2 in Wuhan (Figures 17 & 18).

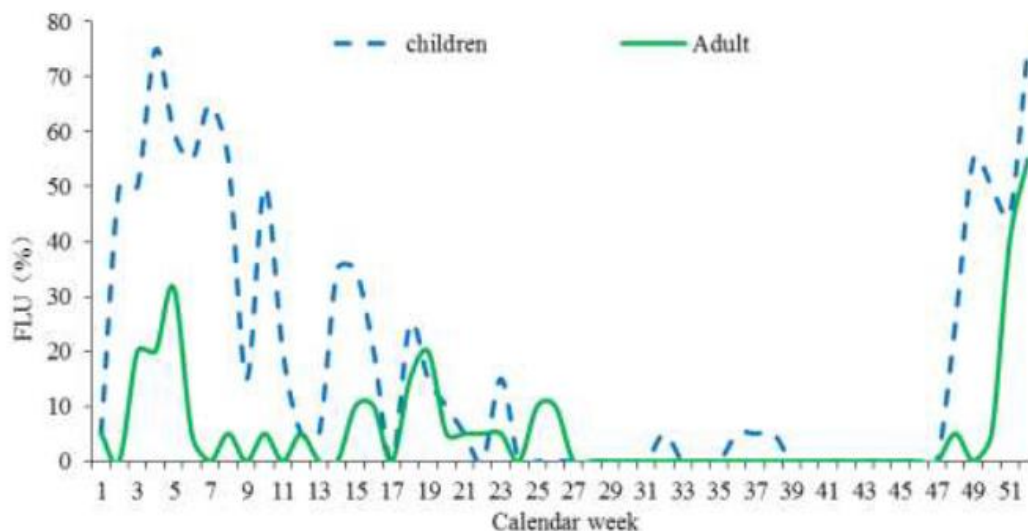

Figure 18. Weekly percentage of ILI cases with laboratory-confirmed influenza [FLU %] in the sentinel surveillance in children and adults in Wuhan in 2019. WHO-convened global study of origins of SARS-CoV-2: China Part  
Source: <https://www.who.int/publications/i/item/who-convened-global-study-of-origins-of-sars-cov-2-china-part>

The China Center for Disease and Control (CCDC) recorded a peak number of reported COVID-19 cases in the first week of February 2020. This rise of adult ILI in Week 46, shown in Figure 17, occurred approximately 13 weeks before the peak COVID-19 cases occurred in Wuhan in the last week of January 2020.<sup>299</sup> Whether the November COVID-19 ILI increase is consistent with this published study deserves further analysis and consideration. China has not made the relevant epidemiological data available to conduct an independent analysis. **It is unknown whether the early November 2019 adult ILI spike was linked to reportedly ill researchers at the WIV.<sup>300</sup> This observation, however, coincides with biosafety activities and concerns at the WIV in mid-November 2019.**

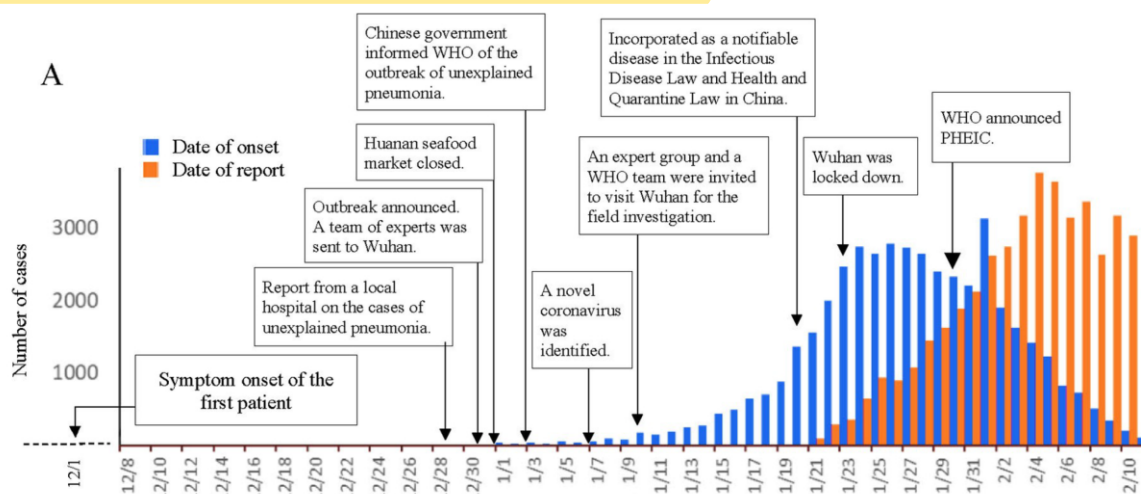

Figure 19. Timeline of the COVID-19 outbreak and official response. Only confirmed cases were analyzed referring to the report by The Novel Coronavirus Pneumonia Emergency Response Epidemiology Team in China.  
Source: Dai, Y., & Wang, J. (2020). Identifying the outbreak signal of COVID-19 before the response of the traditional disease monitoring system. *PLoS neglected tropical diseases*, 14(10), e0008758. <https://doi.org/10.1371/journal.pntd.0008758>

#### d. Abnormal Increase of ILI Possible Early Indicator of COVID Spread

The significant increase in incidence of ILI was also independently confirmed by epidemiologists at Natong and Nanjing Universities. Using data from China’s National Health Commission, they showed an abnormal increase in reported ILI disease at least one month earlier than the clinical reports of pneumonia with unknown causes from China’s conventional hospital reporting system.<sup>301</sup> Their research showed a significantly higher ILI case numbers in 2019 than those reported in the previous years of 2014–2018 ( $P < 0.05$ ). They observed a fast-growing period of ILI from November to December. Their observations suggested that COVID-19 cases may have occurred before December 2019.

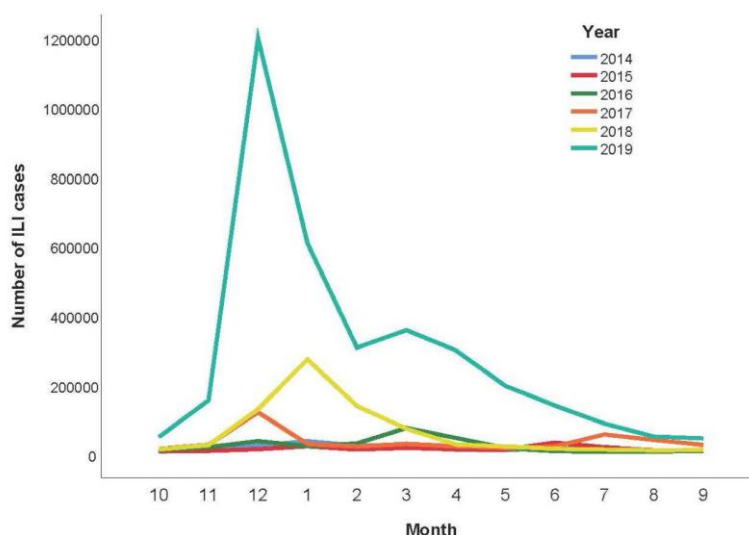

Figure 20. China National Health Commission (NHC) Reported influenza-like illness (ILI) cases during 2014–2019: Comparison of monthly reported ILI cases in different years.

Source: Dai, Y., & Wang, J. (2020). Identifying the outbreak signal of COVID-19 before the response of the traditional disease monitoring system. *PLoS neglected tropical diseases*, 14(10), e0008758. <https://doi.org/10.1371/journal.pntd.0008758>

#### e. U.S. Consulate Reports “Vicious” Flu Season

Diplomats stationed at the U.S. Consulate General in Wuhan have attested to their anecdotal observation of what they believed at the time to be a bad flu season. The Deputy Consular Chief writing in April 2020 recalled:

“By **mid-October 2019**, the dedicated team at the U.S. Consulate General in Wuhan knew that the city had been struck by what was thought to be an unusually vicious flu season. The disease worsened in **November**. When city officials began to close public schools in **mid-December** to control the spread, the team passed the word to Embassy Beijing and continued monitoring.”<sup>302</sup>

Schools in China are not typically closed during December. The winter holiday break begins in late January and goes on until early February. These dates vary depending on the date of the Lunar New Year of that particular year. The holiday period begins 15 days before and lasts 15 days after the Lunar New Year.

The published NHC ILI surveillance data showing a dramatic increase in ILI in November ILI surveillance data supports reports from U.S. State Department Consular staff based in Wuhan that the city was experiencing an “unusually vicious flu season.”<sup>303</sup>

**f. Wuhan Hosts Military World Games, Athletes Report Illness**

More than 9,000 international athletes from over 109 countries traveled to Wuhan for the Military World Games running **October 18** through **October 27, 2019**.<sup>304</sup> Many of them, including athletes from France, Italy, Germany, Luxembourg, and Canada, reportedly became ill while in Wuhan, or shortly after returning to their countries, with non-specific symptoms consistent with COVID-19.<sup>305,306,307</sup> Eleven Iranian athletes reportedly died of COVID-19, including some who participated in the Military World Games, although information on these deaths is limited.<sup>308</sup>

The investigation became aware of the development of serological testing sponsored by DARPA that could retrospectively assess the timing of one’s COVID-19 infection.<sup>309,310</sup>

**g. Hospital Traffic & Online Searches for COVID-19 Symptoms Spike**

A team of scientists led by a Harvard Medical School Professor in June 2020 found evidence of an unusual increase in hospital traffic during October and November 2019.<sup>311,312</sup> The team analyzed satellite imagery of vehicular traffic at hospitals in Wuhan. The satellite data showed a significant increase in vehicles parked at major Wuhan hospitals – an indicator previously established as a proxy for hospital occupancy rates – in October and November 2019 compared to the same time period in 2018. The increase in parked cars was observed at five of the six hospitals that were examined, with as much as a 90 percent rise in some cases.<sup>313,314</sup>

A second indicator examined by the team was the frequency of queries made on the Chinese search engine Baidu. Search queries for terms like “cough” also increased substantially in October and November, 2019, although it fluctuated in a manner more consistent with yearly influenza seasons.<sup>315</sup> The Harvard study noted that Baidu searches for diarrhea also increased during the study period, though beginning earlier in August.<sup>3</sup> Diarrhea is not typically seen as a prominent initial symptom in influenza and not used in screening criteria for influenza-like-illness.<sup>316</sup> Diarrhea was noted as initial presenting symptom of COVID-19 in 19.4% of individuals experiencing mild disease illness.<sup>317</sup> Patients with digestive symptoms also presented for care later than those with respiratory symptoms.<sup>318</sup>

---

<sup>3</sup>The study also examined the increase in searches using the diarrhea which showed a substantial increase beginning in August, 2019 not seen in previous influenza seasons. The Harvard team speculated that, “[w]hile surprising, this finding lines up with the recent recognition that gastrointestinal symptoms are a unique feature of COVID-19 disease and may be the chief complaint of a significant portion of presenting patients.”<sup>3</sup> Critics have taken issue with the Chinese language translation of “diarrhea” while further noting that diarrhea is not among the most common symptoms of COVID-19.<sup>3</sup> This is fair criticism and represents a limitation to the study’s findings with respect to its claim that SARS-CoV-2 may have been circulating in Wuhan in August, 2019. Circulation of SARS-CoV-2 in August would be a much earlier emergence date than is suggested by other available evidence and should be treated with skepticism.

By contrast, the WHO-China Report found no evidence of unusually high rates influenza-like-illness (ILI), including when examining data collected by China's influenza and SARS surveillance systems until mid- to late November, 2019, contradicting the Harvard study results. The Harvard study findings are supported by ILI disease reporting by epidemiologists using China's National Health Commission data.<sup>319</sup>

#### **h. China Launches COVID-19 Vaccine Program**

An article including a February 2020 interview with Shi Zhengli described how the NHC organized efforts to evaluate the SARS-CoV-2 virus.<sup>320</sup> The article states the NHC established four research groups to characterize the virus.<sup>321</sup> This investigation determined that as process of characterizing the virus, these four teams also likely evaluated and developed potential medical countermeasures.

The article did not explicitly identify the four teams. This investigation identified four teams of researchers who were involved in China's early COVID-19 vaccine development. Two groups were led by researchers from AMMS. One group was from the China CDC and CAS. The final research team was from the WIV and CAS. **Based on public announcements, vaccine patents, published vaccine related reports and analysis by this investigation at least two of these vaccine development efforts began no later than November-December 2019, prior to the recognized or announced COVID-19 outbreak.**

Animal vaccine challenge studies supporting two of the vaccine development efforts were identified at two of China's high-containment laboratory complexes at Harbin and Kunming. This investigation deduced that additional animal vaccine challenge studies occurred at the WIV and possibly the Wuhan University's Institute of Animal Models. **The timing of these experiments began no later than November 2019. The type of vaccines used for these animal experiments required the sequence of the SARS-CoV-2 virus and the challenge studies required the whole, live virus. This means SARS-CoV-2 would have been present at the WIV before the known outbreak of the pandemic.**

#### **i. Rumors of New Virus Spread in Wuhan, Doctors See Influx of Patients**

An award-winning investigative journalist in Australia interviewed a frontline doctor from Wuhan who said he and his colleagues began seeing a growing number of patients exhibiting fever and respiratory difficulties in **early November**, 2019 and realized that a coronavirus, likely SARS, was the causative agent by early December, but were forbidden by the authorities from discussing the problem.<sup>322</sup>

#### **j. WIV Researchers Hospitalized with COVID-19 Symptoms**

The U.S. Department of State released a factsheet in January 2021 on its official website that stated the following:

**The U.S. government has reason to believe that several researchers inside the WIV became sick in autumn 2019, before the first identified case of the outbreak, with symptoms consistent with both COVID-19 and common seasonal illnesses. This raises**



questions about the credibility of WIV senior researcher Shi Zhengli's public claim that there was 'zero infection' among the WIV's staff and students of SARS-CoV-2 or SARS-related viruses.<sup>323</sup>

In August 2021, Josh Rogin, a veteran foreign policy columnist for the *Washington Post*, revealed that the intelligence had further showed that at least one of the WIV researchers became ill in **early November** 2019 and that all three worked at Shi Zhengli's bat coronavirus lab at the WIV, and exhibited symptoms highly specific to COVID-19, including the loss of smell and ground-glass opacities in their lungs.<sup>324</sup>

However, the Office of the Director of National Intelligence's (ODNI) Updated Assessment on COVID-19 Origins cautions that "information indicating that several WIV researchers reported symptoms consistent with COVID-19 in autumn 2019 is not diagnostic of the pandemic's origins. "Even if confirmed, hospital admission alone would not be diagnostic of COVID-19 infection."<sup>325</sup> While vague, this statement suggests that ODNI believes the WIV researchers may not have been infected with COVID-19 or, if they were infected, that the infections may have occurred as a result of human-to-human transmission in Wuhan as opposed to a research-related infection. As of the date of this report, ODNI has declined to provide further information supporting its assessment.

**k. Wuhan University Biostatistics Professor Identifies Cases with Symptom onset in mid-November 2019**

Yu Chuanhua, professor of biostatistics at Wuhan University, gave an interview in February 2020 in which he discussed his work to compile a nationwide database of COVID-19 cases, both confirmed and suspected, which had 47,000 cases by late February 2020.<sup>326</sup> Yu noted several suspected, but unconfirmed cases that predate the earliest official cases in December 2019. "There were two patient cases in November, with onset on **November 14** and **November 21**, 2019, and five or six cases before December 8, 2019. Among them, a patient who became ill at the end of November was hospitalized on December 2 and was clinically diagnosed with pneumonia."<sup>327</sup>

Yu Chuanhua also noted that public health officials conducting retrospective searches for earlier cases had identified a suspected COVID-19 case in late September 2019. "The data shows the patient has not undergone nucleic testing; the clinical diagnosis (CT scan diagnosis) is a suspected case. The patient has already died. The data did not have a diagnosis, [or] the date and time of death, it could also be incorrect data."<sup>328</sup> The article was published 4 days (February 27) before PRC officials announced a gag order restricting data related to the outbreak on March 3, 2020. Professor Yu reportedly called the reporter two days after the interview to retract his statements as inaccurate.<sup>329</sup>

**l. Unpublished PRC Government Data Lists COVID-19 Cases in Mid-November, including Earliest Known Potential Index Case**

The China News Editor of the *South China Morning Post* (SCMP), a veteran reporter with more than two decades of experience, reviewed official government data that documented a 55-year-old from

Hubei province (Wuhan is its capital), who contracted the virus on **November 17, 2019** apparently the earliest confirmed case of COVID-19.<sup>330</sup> According to SCMP:

From that date onwards, one to five new cases were reported each day. By December 15, [2019] the total number of infections stood at 27 – the first double-digit daily rise was reported on December 17[, 2019] – and by December 20, [2019] the total number of confirmed cases had reached 60.<sup>331</sup>

The SCMP provided the following details on the earliest cases: “Of the first nine cases to be reported in November – four men and five women – none has been confirmed as being patient zero. They were all aged between 39 and 79, but it is unknown how many were residents of Wuhan.”<sup>332</sup>

At the time of publication in March 2020, the SCMP indicated that Chinese authorities had identified at least 266 people who were infected in 2019, “all of whom came under medical surveillance.”<sup>333</sup> The SCMP reporting is consistent with reporting by CNN on leaked PRC government documents it received showing that PRC officials had detected “around 200” confirmed and clinically diagnosed COVID-19 cases in 2019, instead of the 44 cases China reported to the WHO on January 3, 2020.<sup>334</sup>

**m. English Teacher Develops Pneumonia, Later Confirmed to be COVID-19**

On **November 25, 2019** a 25-year-old Welsh man named Connor Reed, who was teaching English in Wuhan, fell ill with flu-like symptoms. The symptoms appeared to wane after a few days, only for Reed to develop pneumonia on **December 6, 2019**.<sup>335,336</sup> On **January 16, 2020**, the hospital that treated him for pneumonia formally informed Reed by letter that he had been infected by the novel coronavirus.<sup>337</sup> Reed kept a diary while he was sick, which he shared with various British media outlets beginning in March 2020 as the pandemic spread to the United Kingdom. He is the first Briton known to contract the virus.<sup>338</sup>

**n. Serological Studies on Pre-Pandemic Samples Indicate SARS-CoV-2 Circulating Internationally in November and December 2019**

Researchers in Italy, France, the United States, and Norway have published studies, examining retrospectively tested biological samples collected before the start of the COVID-19 pandemic in those countries, suggesting that SARS-CoV-2 may have been circulating undetected in their countries beginning in December, 2019.<sup>339</sup> Serological analysis of blood donations in California, Oregon and Washington as early as 13-16 December showed a small percentage of reactive antibodies to SARS-CoV-2.<sup>340</sup> However, similar retrospective studies testing samples for SARS-CoV-2 conducted in Germany, Canada, Japan, the United Kingdom, Spain, Italy, and the United States have found no evidence of the virus circulating.<sup>341</sup>

Table 3. Studies tested pre-pandemic samples for SARS-CoV-2 early occurrence. *Source:* <https://www.who.int/publications/m/item/scientific-advisory-group-on-the-origins-of-novel-pathogens-report>

Country	Date of First Reported COVID-19 Case	Case Study Period of the Samples	Number of Positive Samples (date of earliest detection)	Number of samples tested	Sample Type
Italy	Jan. 30, 2020	Dec. 2019	15 (Dec. 2019)	N/A	Sewage
		Nov. 2019	1 (Nov. 2019)	1	Skin Biopsy
		Nov. 2019 – Mar. 2020	11 (Nov. 2019)	290	Plasma
		Sept. 2019 – Feb. 2020	1 (Dec. 2019)	39	Throat Swab
France	Jan. 24, 2020	Nov. 2019 – Mar. 2020	13 (Nov.- Dec. 2019)	9,144	Serum Samples
		Dec. 2019 – Jan. 2020	1 (Dec. 2019)	14	Respiratory Samples
United States	Jan. 20, 2020	Oct. 2019 – Mar. 2020	7 (Mid-Jan. 2020)	2,321	Nasopharyngeal swabs
		Jan. 2020 – Mar. 2020	9 (Jan. 2020)	24,079	Blood
		Dec. 2019 – Jan. 2020	106 (reactive) of 7389 samples (Mid-Dec. 2019)  84 of 90 had neutralizing activity (Mid-Dec. 2019).	7,389	Blood
Norway	Feb. 26, 2020	Dec. 2019 – Dec. 2020	36 (1 from Dec. 12, 2019)	6,520	Serum Samples

These retrospective studies tested a variety of sample types and technology, which impacts each studies' reliability and relevance. As the WHO Scientific Advisory Group for the Origins of Novel Pathogens Preliminary Report notes, "the methods of each study with results indicating positive samples in 2019 requires further validation and verification and thus the significance of these findings remains unclear."<sup>342</sup> Nevertheless, these surveys are evidence that SARS-CoV-2 may have been circulating at low level internationally for weeks before the first cases in a given country were detected. However, it is also possible that they are false positives and do not actually indicate pre-2020 infections outside of China.

**o. Additional Sewage Water and Clinical Testing Identifies Earlier SARS-CoV-2 Incidence in Italy, Brazil and France.**

Analyses of sewage samples from Brazil, Italy, and France indicate SARS-CoV-2 was circulating internationally in late November and December 2019, well before the recognized outbreaks in those countries.<sup>343,344,345</sup>

## 2. Outbreak Underway: December 2019

### a. Wuhan Closes Schools Because of Outbreak

An investigative journalist who interviewed frontline doctors in Wuhan in 2020 indicated that some doctors reported that classes in some high schools were temporarily cancelled in November 2019 because students were getting infected with what was being described as a severe influenza.<sup>346</sup> A diplomat stationed at the U.S. Consulate General in Wuhan, writing in April 2020, recalled that local authorities closed down public schools in December 2019.

The deputy consular chief wrote: “When city officials began to close public schools in mid-December to control the spread of the disease, the team passed the word to Embassy Beijing and continued monitoring. The possibility of a new viral outbreak was always on the consulate’s radar. Still, the working assumption in every scenario had always been that, as in past outbreaks like H1N1 (known as swine flu), it would appear in rural areas first and then spread to major urban centers across China.”<sup>347</sup>

### b. Chinese Social Media Begins to See an Increase in Requests for Help for Medical Treatments in Wuhan

In June 2020, a team of Chinese researchers published a study analyzing the geo-tagged location of requests for medical help on the Chinese social media platform Sina Weibo.<sup>348</sup> The period of time for the focus of the study was February 3 to 12, 2020, but it included data from as early as December 20, 2019. The study found that Wuhan accounted for 99% of requests for medical assistance on Weibo with a substantial number of requests for medical assistance from **December 20**, 2019 to January 23, 2022. The study concluded that there were “multiple outbreak centers” across Wuhan in “high-density residential areas” and that neighborhoods with a larger elderly population seeing more requests for help.<sup>349</sup> Specifically, the early outbreaks appear to have occurred in several neighborhoods nearly simultaneously:

The new coronavirus epidemic showed the obvious spatiotemporal characteristic of scattered infection, community spread, and full-scale outbreak in the early stage [of the outbreak], which was specially manifested in the process of mobile diffusion centered on early cases found in Jiang’an, Jianghan, Qiaokou, Wuchang, Hongshan, and Hanyang districts before January 23.

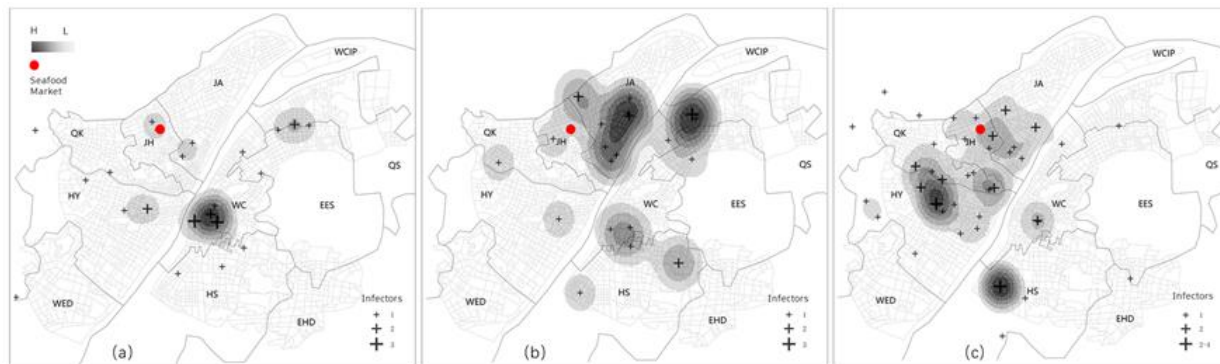

Figure 21. Spatial distribution of help seekers from December 20th, 2019 to January 22nd, 2020: (a) before January 18th, 2020; (b) from January 19th to 20th, 2020; and (c) from January 21st to 22nd, 2020. Source: Peng Z, Wang R, Liu L, Wu H. Exploring Urban Spatial Features of COVID-19 Transmission in Wuhan Based on Social Media Data. ISPRS International Journal of Geo-Information. 2020;9(6):402. <https://doi:10.3390/ijgi9060402>

The earliest requests for medical help, from **December 20**, 2019 to January 17, 2020, clustered approximately 6.5 miles from the Huanan Seafood Market on the opposite side of the Yangtze River in the Wuchang District of Wuhan.<sup>350</sup> It was not until January 31, 2020, after Wuhan entered lockdown that the number of requests for help spiked in the neighborhoods surrounding the Huanan Market. As a result, the study observed that, “[i]nterestingly the Huanan Seafood Market, regarded as the origin of the outbreak, had not been the geographic center of epidemic outbreak” although noted this could be attributed to the area’s medium population density and low proportion of elderly people.<sup>351</sup>

### c. Prefecture in Western Hubei Province Orders Live Animal Farms Shutdown

*The Washington Post*, citing an article by PRC state-controlled media, reported that officials in Enshi Prefecture, located approximately 150 miles west of Wuhan in the western end of Hubei Province, “closed all wild animal and live poultry transactions” at markets on **December 23**, 2019.<sup>352,353</sup> This pre-dates the first public announcements of the COVID-19 outbreak by a week. Neither *The Washington Post* nor Chinese state-controlled media stated whether samples were collected from animals present in Enshi area markets before their closure.

Enshi is a rural area. *The Washington Post* article further noted that, based on a review of farm licenses, “small farms that collectively housed hundreds of thousands of wild mammals such as civets, ferret badgers and raccoon dogs before the pandemic.”<sup>354</sup> Again citing to PRC state controlled media, the article notes that “Enshi accounted for 17 percent of Hubei wildlife farms shut down in the pandemic, official announcements show. Authorities estimated that the 290 shuttered Enshi farms had 450,000 to 780,000 animals.”<sup>355,356</sup> Again, whether any of the animals at these farms were sampled for COVID-19 testing is unknown.

### d. Clinicians Report Clusters of Unknown Pneumonias with link to Huanan Seafood Market to Wuhan Public Health Authorities

On **December 26**, 2019, Dr. Jixian Zhang of the Hubei Integrated Chinese and Western Medicine<sup>4</sup> (HICWM) hospital became the first known clinician to recognize what would become COVID-19, according to an article in the Journal of the American Medical Association (JAMA) written by Chinese CDC officials in February, 2020.<sup>357</sup> On that day, Dr. Zhang “noticed” 4 unusual cases of pneumonia, including three cases in the same family.

These three family members are referred to as “cluster 1” in the WHO-China Joint Report. This family unit consisted of a 62-year-old male, initially thought to have a symptom onset date of December 1, 2019 but later determined by PRC health officials to have a symptom onset date of December 26, 2019 his wife who was hospitalized with COVID-19 on December 26, 2019 and their son, who tested positive but was asymptomatic. Neither the son nor the husband had exposure to the Huanan Seafood Market, but the wife “reported close contact with the Huanan Market.” It is unclear whether Dr. Zhang discovered the epidemiological link with the Huanan Market, although one experienced western epidemiologist believes – based on the information available to date – Dr. Zhang was likely the first clinician to notice and report the link.<sup>358</sup> Dr. Zhang then reported these cases to hospital authorities and then to the local district CDC on **December 27**, 2019.<sup>359</sup>

On **December 30**, 2019, the Wuhan Municipal Health Commission circulated two confidential urgent notices to the city’s medical institutions. The first notice was sent at 3:10 PM local time and stated, “[t]here has been a continuous occurrence of pneumonia cases of unknown cause at the Huanan Seafood Market in our city.”<sup>360</sup> Officials ordered hospitals to compile statistics on all such cases admitted in the previous week and report them to the commission before 4:00 PM.<sup>361</sup> The response was due less than an hour after the order was sent. The notice prohibited recipients from sharing information with anyone without state authorization: “all work units and individuals who have not received authorization must not arbitrarily release critical care information to the outside world.”<sup>362</sup>

This first confidential notice was leaked by health care workers on social media within 12 minutes of its release to hospitals. The second urgent notice was published at 6:50 PM. It stated: “Some medical institutions in our city have had a continuous occurrence of patients with pneumonia of unknown cause.”<sup>363</sup> While the urgent notices describe basically the same concern, they differ in that the first notice specifies continuous occurrence of cases “at the Huanan Seafood Market” while the second notice does not reference the market.

On **December 31**, 2019 at 1:38 PM local time, the Wuhan Municipal Health Commission issued a public notice of the outbreak.<sup>364</sup> This notice was the first disclosure of the outbreak made by PRC authorities that was intended for the general public. It acknowledged a total of 27 cases of pneumonia, all linked to the Huanan Seafood Market.<sup>365</sup> The report’s connection of the outbreak with the Huanan Seafood Market led media outlets, government officials, and public health authorities to immediately speculate that SARS-CoV-2, like SARS, spilled over into humans at the market.

On that same day, a machine translation of a Chinese media report about the outbreak is posted to ProMED, a U.S.-based open-access platform for early intelligence about infectious disease outbreaks.

---

<sup>4</sup> Also known as the Xinhua Hospital.

WHO headquarters in Geneva sees the ProMED post and instructs the WHO China Country Office to request verification of the outbreak from China's government. The Wuhan Municipal Health Commission issues its first public statement on the outbreak, saying it has identified 27 cases.<sup>366</sup>

On **January 1, 2020**, Wuhan authorities shut down the city's Huanan Seafood Wholesale Market.

## Chapter 3: Early COVID-19 Epidemiology, Anomalies & Shortcomings in China's Response

### Introduction

Surprisingly, given its investments in disease surveillance and past successes, China faltered in its early response to the SARS-CoV-2 outbreak. These early missteps, occurring mostly from late-December 2019 through January 2020 cannot solely be attributed to good faith mistakes made while responding to the outbreak of a novel respiratory disease. Rather, many of the evidentiary gaps in the world's understanding of the emergence of SARS-CoV-2 are the result of the PRC censorship and the deliberate destruction or withholding of evidence.

#### 1. Early Identification and Outbreak Epidemiology

As reported by the CCDC, on December 29, 2019, four patients with pneumonia of unidentified etiology were admitted to a Wuhan hospital. Hospital officials learned that all four patients worked in the Huanan Seafood Wholesale Market – a local market known to sell various types of live animals, including wildlife. The hospital reported these patients to the Wuhan (Hubei Provincial) CDC which began a retrospective search for other potential pneumonia of unidentified etiology cases with links to the market. Wuhan CDC investigators discovered additional potential patients and reported their findings to the CCDC on December 30, 2019.<sup>367</sup> The following day (December 31, 2019), the Wuhan Municipal Health Commission issued a public alert<sup>368</sup> and revealed that they had identified 27 patients.<sup>369</sup> A rapid response team from the CCDC was sent to Wuhan to support the investigation and control efforts.

The CCDC reported that samples were obtained from the four patients admitted to a Wuhan hospital on December 29, 2019, for laboratory analysis and that the sequence of a novel coronavirus (nCoV) was discovered from patient specimens on January 3, 2020. Internal confirmation that the nCoV sequenced on January 3 caused COVID-19 followed on January 7, 2020.<sup>3,4</sup> This differs from other information that has been publicly reported. Notably, it has been reported that one Wuhan patient's sample was collected on December 24 and sequenced by December 26, 2019, resulting in the identification of a novel SARS-related CoV.<sup>370,371</sup> The public and global scientific community, however, would not see a SARS-CoV-2 sequence until January 11, 2020, when a Chinese researcher defied a Chinese central government order prohibiting the release of information about the virus, specifically prohibiting the release of the viral sequence and released the sequence associated with an early nCoV infection.<sup>372</sup>

As described by CCDC on February 14, 2020, the geo-temporal center of the initial outbreak was in Wuhan in Hubei province.



## China CDC Weekly

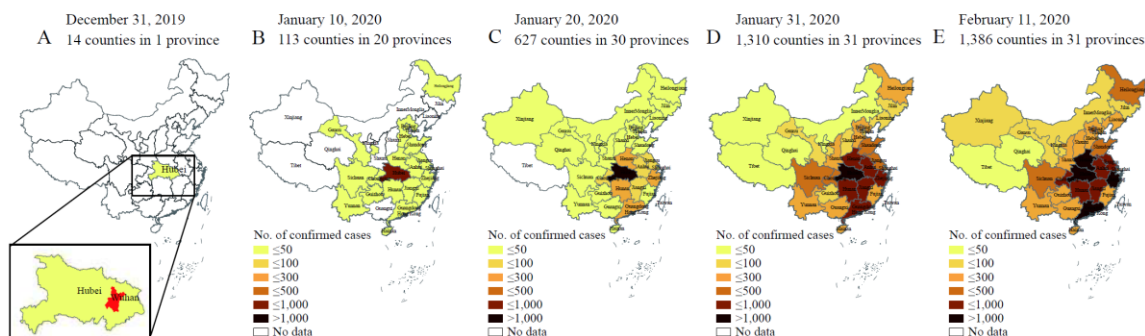

Figure 22. Geo-temporal spread of COVID-19 in China through February 11, 2020. (A) a total of 14 county-level administrative areas (hereafter counties) in Hubei Province only (inset) had reported cases as of December 31, 2019; (B) by January 10, 2020, 113 counties in 20 provincial level administrative divisions (PLADs) had reported cases with the highest prevalence still in Hubei Province; (C) nine days later, on January 20, 627 counties in 30 PLADs had reported cases and PLADs neighboring Hubei Province observed increasing prevalence; (D) by the end of January 31, 1,310 counties across all 31 PLADs were affected and prevalence in the central, south, and south-central regions had risen dramatically; (E) by the end of February 11, 2020 1,386 counties nationwide were affected and prevalence in the south-central PLADs had risen to the level of Hubei. Source: The Epidemiological Characteristics of an Outbreak of 2019 Novel Coronavirus Diseases (COVID-19) — China, 2020. *China CDC Weekly*. 2020;2(8):113-122. <https://doi.org/10.46234/ccdcw2020.032>

The first epidemic curves of COVID-19 in China describe a mixed outbreak pattern. “[T]he data appear to indicate a continuous common source pattern of spread in December [2019] and then from early January through February 11, 2020, the data appear to have a propagated source pattern (Figure 24).”<sup>373</sup> The CCDC described that the early events were “consistent with the working theory that perhaps several zoonotic events occurred.”<sup>374</sup>

The initial epidemic curve published by the CCDC, however, displays an early December 2019 pattern whose categorization is difficult to distinguish between a point source and continuous common source initial exposure.<sup>5</sup> Both exposure sources, for example, would display epidemic curves that increase sharply as seen in the CCDC epidemic curve.<sup>375</sup> It is also important to remember that these curves likely miss a significant proportion of the asymptomatic COVID-19 cases in Wuhan at the time. The CCDC also notes the high number of cases among healthcare workers from late December 2019 to mid-February 2020, describing 1,716 confirmed cases among healthcare workers during this period.<sup>376</sup> This rate of healthcare worker infection underscores the transmissibility of early circulating SARS-CoV-2.

<sup>5</sup> A point source outbreak has an epidemic curve with a tight clustering of cases in time ( $\leq 1.5$  times the range of the incubation period, if the agent is known) and with a sharp upslope and a trailing downslope. Continuous common source outbreaks continue over time. The epidemic curve will increase sharply but evolve into a plateau versus a point seen in a point source outbreak. Source: Rasmussen SA and Goodman RA. (2019). *The CDC Field Epidemiology Manual*. New York: Oxford University Press.

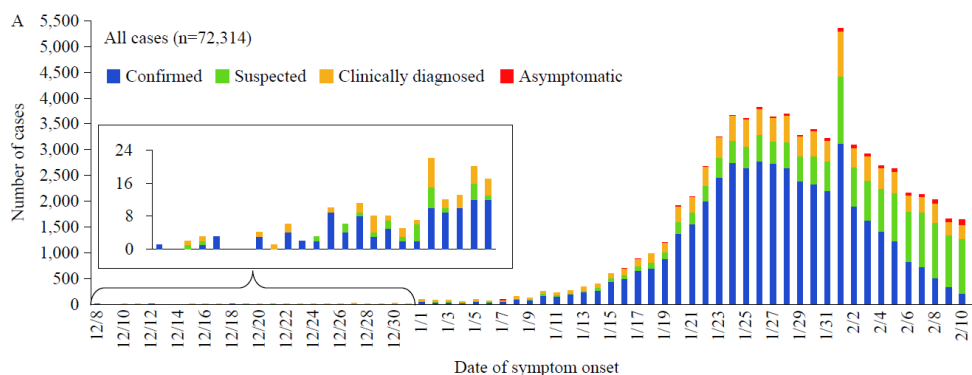

Figure 23. Epidemiological curves of COVID-19 in China through February 11, 2020. The epidemiological curve shows the progression of illness in the outbreak over time from December 8, 2019, to February 11, 2020. A total of 72,314 cases are shown and confirmed cases (blue) are compared to suspected cases (green), clinically diagnosed cases (yellow), and asymptomatic cases (red). The inset shows a zoomed-in view of all days in December, when total daily count remained below 24 cases. Source: The Epidemiological Characteristics of an Outbreak of 2019 Novel Coronavirus Diseases (COVID-19) — China, 2020. *China CDC Weekly*. 2020;2(8):113-122.

[https://doi.org:10.46234/ccdcw2020.032](https://doi.org/10.46234/ccdcw2020.032)

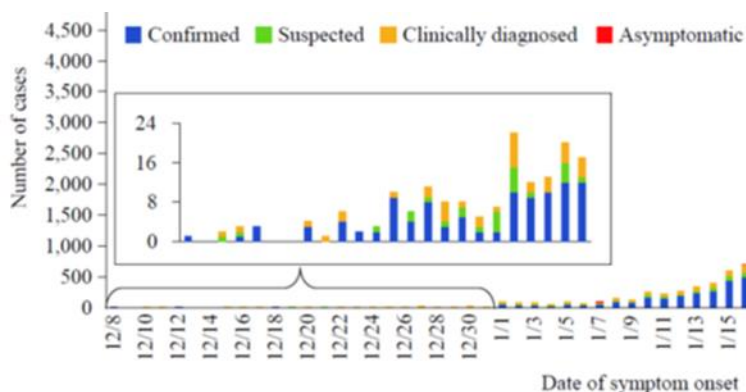

Figure 24. China CDC early Wuhan outbreak epidemic curve. Source: The Epidemiological Characteristics of an Outbreak of 2019 Novel Coronavirus Diseases (COVID-19) — China, 2020. *China CDC Weekly*. 2020;2(8):113-122.

[https://doi.org:10.46234/ccdcw2020.032](https://doi.org/10.46234/ccdcw2020.032)

Epidemiological modeling and reports of early COVID-19 cases converge on mid-October to mid-November, 2019 as the most likely timeframe for the spillover of SARS-CoV-2.<sup>377,378</sup> Based on the publicly available evidence, it appears Wuhan is the only location where SARS-CoV-2 spilled over into humans.<sup>379</sup> The low genetic diversity of earliest SARS-CoV-2 samples suggests that COVID-19 pandemic is most likely the result of a single successful introduction of SARS-CoV-2.<sup>380,381</sup>

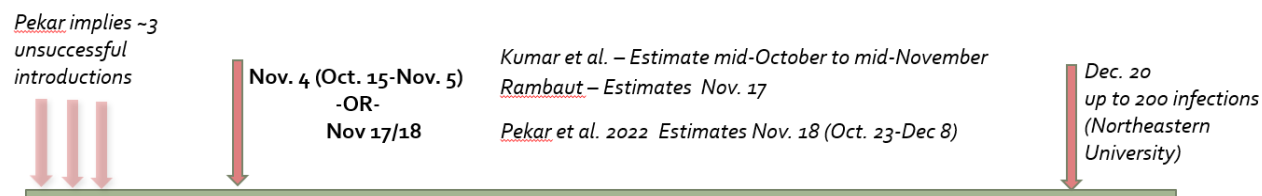

Figure 25. Compilation of published epidemiological and molecular aging models estimating the initial emergence of SARS-CoV-2 based on available epidemiological & genetic data of COVID-19 cases. *Note: ~3 unsuccessful introductions denote 3 human infections that did not subsequently propagate to produce additional cases.*

Although, the possibility of two independent spillovers cannot be ruled out.<sup>382</sup> The CCDC assessed the early Wuhan outbreak based on available epidemiology to be consistent with a continuous common source.<sup>383</sup> This means that over a period of time extending beyond the incubation period, multiple people were infected over time. This continuous common source cause of the COVID-19 outbreak is consistent with a resultant seeding of the virus in Wuhan and its ultimate spread to multiple locations around the city. As described by the U.S. CDC in some common-source outbreaks, case-patients may have been exposed over a period of days, weeks, or longer. In a continuous **common-source outbreak**, the range of exposures and range of incubation periods tend to flatten and widen the peaks of the epidemic curve.<sup>384</sup>

## 2. Anomalies and Shortcomings

### a. Overly Narrow Case Definitions During Early Outbreak Leads to Under Counting of Early COVID-19 cases.

As part of its infectious disease surveillance reforms in the wake of the SARS epidemic, the CCDC created a new notifiable disease “viral pneumonia of unexplained etiology”<sup>6</sup> (VPUE).<sup>385</sup> Regulations require PRC health care facilities to report to CCDC any patient who is clinically diagnosed with unexplained pneumonia and whose illness meets five criteria:

- 1) fever  $\geq 38$  °C [100.4°F];
- 2) radiologic characteristics consistent with pneumonia;
- 3) normal or reduced leukocyte count or low lymphocyte count in early clinical stage;
- 4) no improvement or worsening of the patient’s condition after first-line antibiotic treatment for 3–5 days; and
- 5) the pneumonia etiology cannot be attributed to an alternative laboratory or clinical diagnosis (clinicians are granted flexibility to determine how to interpret this criterion and specific tests are not specified).<sup>386</sup>

To qualify as a reportable VPUE case, the patient must have all five symptoms. Based on reporting by the Chinese language media outlet Caixin, the VPUE reporting system and criteria were in effect in Wuhan in November-December 2019.<sup>387</sup>

<sup>6</sup> Alternatively rendered as “Pneumonia of Unexplained Etiology” (PUE) and Pneumonia of Unknown Cause or Etiology. For consistency, this report will use the term VPUE used by the Wuhan Health Commission.

The VPUE definition may have excluded up to 23% of COVID-19 cases, particularly mild illnesses, that presented with primarily gastrointestinal symptoms.<sup>388</sup> Diarrhea was a common symptom of SARS during the 2003 outbreak. Among the Hong Kong SARS patients, approximately 20% had diarrhea on disease presentation.<sup>389</sup> Of those infected with SARS-CoV-2, 19.4% experienced diarrhea as the first symptom of their illness. COVID-19 patients with digestive symptoms presented for care significantly later than those with respiratory symptoms.<sup>390</sup> Concurrent fever was a significant additional finding found in 62.4% of patients with a digestive symptom.<sup>391</sup> Awareness of under-reporting was noted in a January 29, 2020 published *New England Journal of Medicine* article stating that “the initial focus of case detection was on patients with pneumonia, but we now understand that some patients can present with gastrointestinal symptoms.”<sup>392</sup>

Available evidence, collected by a team of researchers examining the origins of SARS-CoV-2, found that 19 COVID-19 cases were identified by Wuhan clinicians between December 18 and December 30, 2019 using the limited VPUE case definition.<sup>393</sup> Approximately half of these cases were associated with the Huanan Seafood Market, suggesting a “genuine preponderance” connection of the earliest known cases with the Huanan Market.<sup>394</sup>

However, in interviews with Caixin, Wuhan clinicians explained they did not report suspected VPUE cases in NIDRIS as required by regulations.<sup>395</sup> Instead, most VPUE cases were reported orally or via email and mail. At least one hospital required doctors get approval from hospital leadership before informing local officials while national agencies such as the CCDC were deliberately not informed of potential cases until hospital and local officials were sure of the VPUE diagnosis.

This hierarchical approach mirrors the paralysis seen during SARS where local and provincial political leadership failed to inform national entities of the severity of the outbreak out of fear of being punished for bringing news of another infectious disease outbreak.<sup>396</sup> While at the same time they also prevented local clinicians and public health experts from taking steps to address the outbreak. As happened in SARS, this paralysis likely led to a significant underreporting of COVID-19 cases in November and December 2019 that otherwise fit the VPUE diagnosis.

The official public epidemiological investigation into the VPUE began on **December 30, 2019** and, unlike the VPUE criteria, centered on the Huanan Market. A probable case was defined as an individual with VPUE who also had a history of exposure to the Huanan Market or another VPUE probable case.<sup>397</sup> **In short, the earliest official COVID-19 case definitions required a connection to the market or another linked case.**

**The focus on association with the market likely resulted in officials overstating the number of market-linked cases as percentage of total cases from December 30 to January 15.** This may have been a learned behavior from SARS as well as more recent experience investigating H5N1 avian influenza outbreaks in live animal markets. As Japanese researchers noted in early February 2020, “*the emphasis on market-based zoonotic transmission may have been the result of observer bias—i.e., the bias that originates from having preconceptions or subjective feelings about what is being studied that could influence epidemiological observation and even recording information.*”<sup>398</sup>

On **January 15**, 2020 the National Health Commission (NHC) issued its first case definition for the novel coronavirus. While the connection to the Huanan Market was removed, its criteria was complex, narrowly defined, and excluded all but the most severe cases with clear epidemiological links to Wuhan. To meet the initial guidelines for a “clinical diagnosis,” a patient must have had:

1. Direct exposure to a Wuhan wet market, or travelled to Wuhan within two weeks of the onset of illness; and
2. All the following four clinical conditions:
  1. fever;
  2. pneumonia confirmed by chest radiograph;
  3. reduced or normal white blood cell count, or reduced lymphocyte count during the early stage of the illness; and
  4. the patient’s clinical conditions did not significantly improve, or deteriorated, after three days of undergoing standard antibiotic treatments.

Finally, to qualify as a fully “confirmed case,” all of the above criteria for clinical diagnosis must have been met as well as laboratory testing of respiratory specimens (whole genome sequencing) that showed high homology with the novel coronavirus.<sup>399</sup> On **January 18**, 2020 the NHC issued the first of six revisions to the case definition by allowing PCR testing as a means of confirming a case.<sup>400</sup>

Throughout January PCR tests were in extremely short supply, further limiting the number of confirmed cases.<sup>401</sup> It has also been reported that Wuhan hospitals denied admission to patients without a positive test result, creating an additional barrier to confirming a case. Moreover, the NHC and CCDC only authorized<sup>7</sup> the use of test kits made by three relatively unknown Shanghai companies which frequently produced false negatives or inconclusive result.<sup>402</sup> Nevertheless, the CCDC and the NHC reportedly tried to prevent scientists and other companies from testing for the virus using kits that they had independently produced.

In another departure from past practice during previous epidemics, the NHC ordered Wuhan hospitals to send virus samples to central labs under its authority, which delayed patient diagnosis, constrained testing capacity and hampered the independent development of PCR tests.<sup>403</sup> Only four state-run laboratories were authorized to confirm an infection during this time period: the CCDC, the WIV, the PLA AMMS, and the Chinese Academy of Medical Science.<sup>404</sup>

On **January 27**, 2020, the National Health Commission issued its fourth set of surveillance guidelines for the novel coronavirus.<sup>405</sup> This set of guidelines instructed health officials to only report “confirmed cases” in the national tally of infections. “Confirmed cases” were defined to exclude people who had tested positive for the novel coronavirus but displayed only mild clinical symptoms or no

---

<sup>7</sup> The Associated Press later discovered had paid senior CCDC officials for the distribution rights in what may have been a case of corruption.

symptoms at all.<sup>406</sup> In addition to a positive test result, a “confirmed case” had to meet at least one of three epidemiological criteria *and* at least two of three clinical manifestations of the disease.<sup>407</sup>

Distinguishing between a “positive diagnosis” and a “confirmed case” contradicts WHO guidance that “confirmed cases are those diagnosed with COVID-19 virus in the laboratory with or without clinical signs and symptoms.”<sup>408</sup> A public health expert interviewed by VOA said he was not aware of any government worldwide that had adopted the PRC’s approach of excluding positive cases that are pre-symptomatic or asymptomatic from confirmed case counts.<sup>409</sup> Given that more than 80% of COVID-19 cases are asymptomatic or mildly-symptomatic, the Commission’s confirmed case definition excluded a substantial majority of all cases.<sup>410</sup>

On **February 4**, 2020 the National Health Commission issued its fifth edition of surveillance guidelines for the novel coronavirus.<sup>411</sup> This set of guidelines instructed health officials to treat the diagnosis of cases of the novel coronavirus differently for individuals located outside of Hubei province, and those located in Hubei. While suspected cases in Hubei province could be diagnosed with *only two* of the three clinical manifestations,<sup>8</sup> even in the absence of any identified epidemiological links,<sup>9</sup> a suspected case in all other provinces had to fulfil *all three* clinical criteria if an epidemiological link was not established.<sup>412</sup> In both cases, whether inside or outside of Hubei province, a “suspected case” could only become a “confirmed case” if at least two clinical symptoms accompanied a positive test. Patients who tested positive but were asymptomatic, pre-symptomatic, or mildly symptomatic remained excluded from the public count of “confirmed cases.” PRC authorities have reportedly classified the number of known cases that are asymptomatic, pre-symptomatic, or mildly symptomatic in China, but have not made that data public.<sup>413</sup>

#### **b. Delayed Release of SARS-CoV-2 Genomic Sequence**

Doctors from at least eight hospitals in Wuhan sent patient samples to multiple Chinese genomics companies, including the industry-leading Beijing Genomics Institute (BGI), for sequencing in December. The results confirmed it was a SARS-related coronavirus.<sup>414</sup> On the morning of **December 26**, 2019, Vision Medicals, a genomics company in Guangdong province, working on behalf of the Central Hospital of Wuhan, determined that a sample taken from a patient in Wuhan had tested positive for a SARS-related novel coronavirus. By noon, an “emergency meeting” was called at the company, which continued working through the day to sequence the genome and sketch a phylogenetic tree of the virus.<sup>415</sup>

By **December 27**, 2019, Vision Medicals had sequenced almost all of the genome of SARS-CoV-2, and shared its findings with hospital officials by phone and the Chinese Academy of Medical Science.<sup>416</sup> PRC authorities, by contrast, did not admit to the world that the outbreak was caused by a

---

<sup>8</sup> These clinical symptoms were (1) fever and/or respiratory symptoms, (2) pneumonia indicated by chest radiograph, and (3) low or normal white blood cell count, or low lymphocyte count during early onset.

<sup>9</sup> The four epidemiological links were: (1) travel to, or had lived in Wuhan or the surrounding areas or other communities with reported COVID-19 cases, within 14 days before illness onset, (2) contact with patient(s) infected with SARS-CoV-2 (positive for SARS-CoV-2 nucleic acid) within 14 days before onset, (3) contact with patients with fever or respiratory symptoms from Wuhan or the surrounding areas, or from communities with reported COVID-19 cases, within 14 days before illness onset, and (4) had a clustering occurrence.

novel coronavirus until 14 days later on January 9, 2020.<sup>417</sup> The sample sequenced by Vision Medicals was taken from a 65-year-old deliveryman who worked at the Huanan Seafood Market and admitted to the Central Hospital of Wuhan on December 18 with pneumonia.

On **December 24**, 2019, the doctors took fluid samples from his lungs and sent them to Vision Medicals for testing. In a departure from unusual procedure, the company did not send back the results, but rather called the hospital on **December 27**, 2019 to inform them that it was a new coronavirus.<sup>418</sup> Vision Medicals executives visited Wuhan shortly after that phone call to discuss their findings with local hospital officials and the Wuhan Center for Disease Control and Prevention. “There was an intensive and confidential investigation under way, and officials from the hospital and CCDC had acknowledged many similar patients,” according to Caixin.<sup>419</sup>

Using a sample sent to BGI by a hospital in Wuhan on **December 26**, 2019, BGI had fully sequenced the genome by **December 29**, 2019 making it the first known entity to do so.<sup>420</sup> BGI sequenced at least three samples of SARS-CoV-2 drawn from different patients and reported its findings to the Wuhan Municipal Health Commission.<sup>421</sup>

On **January 3**, 2020, the same day the NHC gag order came down from Beijing, Professor Zhang Yongzhen of Fudan University received biological samples packed in dry ice in metal boxes and shipped by rail from Wuhan Central Hospital. Professor Zhang's team at the Shanghai Public Health Clinical Center worked around the clock, and by 2:00 AM on the morning of **January 5**, 2020 they had isolated SARS-CoV-2 and sequenced its full genome.<sup>422</sup> They immediately shared the sequence with the Shanghai Municipal Health Commission and the National Health Commission (NHC) and sought permission to release it.<sup>423</sup> No permission was given. On **January 11**, 2020, six days after sharing his findings with the authorities, Zhang told his research partner Edward Holmes in Australia to release the genomic sequence on two open platforms (Virological.org and GenBank).<sup>424</sup> A day later, the authorities closed Zhang's lab for "rectification," and it remained closed at the end of February 2020.<sup>425</sup>

PRC authorities finally released the sequence to the World Health Organization on **January 12**, 2020,<sup>426</sup> 15 days after the virus was first sequenced. The sequence was released in response to scientist Zhang Yongzheng having first deposited the genome on GenBank on **January 11**, 2020, violation of Beijing's ban on unauthorized disclosure of information related to the virus.<sup>427</sup>

### c. Delayed Admission of Human-to-Human Transmission

On **December 26**, 2019 Dr. Jixian Zhang of the Hubei Integrated Chinese and Western Medicine<sup>10</sup> (HICWM) hospital became the first known clinician to recognize what would become COVID-19, according to an article in the Journal of the American Medical Association (JAMA) written by Chinese CDC officials in February, 2020.<sup>428</sup> On that day, Dr. Zhang “noticed” 4 unusual cases of pneumonia, including three cases in the same family.

---

<sup>10</sup> Also known as the Xinhua Hospital.

These three family members are referred to as “cluster 1” in the WHO-China Joint Report. This family unit consisted of a 62-year-old male, initially thought to have a symptom onset date of December 1, 2019 but later determined by PRC health officials to have a symptom onset date of December 26, 2019 his wife who was hospitalized with COVID-19 on December 26, 2019 and their son, who tested positive but was asymptomatic. Neither the son nor the husband had exposure to the Huanan Seafood Market, but the wife “reported close contact with the Huanan Market.”

It is unclear whether Dr. Zhang discovered the epidemiological link with the Huanan Market, although one experienced western epidemiologist believes Dr. Zhang was likely the first clinician to notice and report the link.<sup>429</sup> Dr. Zhang then reported these cases to hospital authorities and then to the local district CDC on **December 27**, 2019.<sup>430</sup> This family cluster should have been a clear epidemiological sign that human-to-human transmission of SARS-CoV-2 was occurring.

Based on the *Wall Street Journal's* reporting, it appears that Wuhan clinicians treating early COVID-19 cases were aware of human-to-human transmission by **December 21**, 2019. For example, Dr. Zhang Jinnong, the head of the Xiehe Hospital's emergency department in Wuhan, “remembers the first [Huanan Seafood Market] patients coming in between Dec. 10 and 16.”<sup>431</sup> Other Wuhan doctors who spoke to *The Journal* reported seeing patients with COVID-19 like symptoms starting in mid-December but claimed that it was not until around December 21 to December 27, 2019 that they realized there was human-to-human transmission.<sup>432</sup>

On **January 11**, 2020 the same day that Zhang Yongzhen released the genomic sequence of SARS-CoV-2 to the world, the National Health Commission (NHC) released a report titled “Notification of Wuhan Municipal Health Commission on Unexplained Viral Pneumonia.”<sup>433</sup> The NHC report continued to deny the occurrence of human-to-human transmission: “All 739 close contacts, including 419 medical staff, have been under medical observation and no relevant cases have been found ... no clear evidence of human-to-human transmission has been found.”<sup>434</sup> On the same day, the Wuhan Municipal Health Commission issued a Q&A factsheet claiming that “most of the unexplained viral pneumonia cases in Wuhan this time have a history of exposure to the South China seafood market. No clear evidence of human-to-human transmission has been found.”<sup>435</sup>

On **January 13**, 2020, Thailand's Ministry of Public Health reported that a 61-year-old Chinese woman arriving at the airport in Bangkok had tested positive for the novel coronavirus. She had not visited the Huanan Seafood Market in Wuhan where the authorities suggested the outbreak began, but she had visited a different market where live animals may have been on sale. Four days later, the Thai ministry announced that a 74-year-old Chinese woman had been quarantined on arrival in the country and had tested positive.<sup>436</sup> On **January 15**, 2020 Japan's Ministry of Health announced that a Japanese man in his thirties who had been to Wuhan tested positive for the virus on his return to Japan.<sup>437</sup> Japan's Health Ministry said the patient had not visited any markets in China, adding that “it is possible that the patient had close contact with an unknown patient with lung inflammation while in China.”<sup>438</sup> On **January 19**, 2020 South Korea identified its first confirmed case: a 35-year-old Chinese woman who flew from Wuhan to Seoul and was isolated on entry into the country because of her symptoms, including a high fever.<sup>439</sup>



On **January 14**, 2020 the Wuhan Municipal Health Commission released a public statement claiming: “Among the close contacts [of patients diagnosed with the novel coronavirus], no related cases were found.”<sup>440</sup> As discussed above, multiple cases of transmission between family members, including individuals who were never exposed to the market, had been documented by no later than December 10, and Dr. Zhang Jixian had even documented asymptomatic transmission in a family cluster by December 27. These findings had been reported to the Wuhan Municipal Health Commission well in advance of this misleading public statement. By **January 12**, 2020 Beijing, Shanghai, and Shenzhen municipalities, which span from northern China to eastern China to southern China, had all reported to the NHC confirmed cases of patients who had no history of exposure to the Hainan Seafood Market in Wuhan – further evidence indicating that the virus was spreading from person-to-person.

On **January 20**, 2020 at 11:17 PM local time, the official Xinhua News Agency ran an interview with Dr. Zhong Nanshan in which he became the first PRC official to acknowledge that SARS-CoV-2 was infectious and spreading between people, confirming two cases in Guangzhou of individuals who had not travelled to Wuhan, but had been infected by family members who had visited Wuhan. Zhong also acknowledged for the first time that infections among medical personnel had occurred.<sup>441,442</sup>

Despite the belated admission of person-to-person transmission, Zhong downplayed the severity of the situation, calling it a “*localized* outbreak” in Wuhan.<sup>443</sup> Zhong “expressed confidence” that the outbreak could be controlled, and suggested that the new coronavirus was not as dangerous as SARS-CoV-1 when, in fact, it was much more transmissible: “I do not believe this virus will cause the social impact and economic losses as SARS did 17 years ago.”<sup>444</sup> In actuality, cases were being confirmed elsewhere in China and in neighboring countries. Wuhan’s hospitals were already overwhelmed with patients, and the authorities would impose an unprecedented lockdown on the city just three days later.

On **February 14**, 2020 the National Health Commission acknowledged that SARS-CoV-2 was spreading to and among medical professionals, and that a total of 1,716 healthcare workers had been infected in China.<sup>445,446</sup> That disclosure meant that the number of healthcare workers in China infected with the SARS-CoV-2 had already exceeded the global total of healthcare workers infected during the entirety of the SARS epidemic from 2002-2003.<sup>447</sup> The actual number of infections would likely be much higher if the authorities had counted asymptomatic, pre-symptomatic, and mildly symptomatic cases. Readers will recall that the authorities explicitly denied any infections among medical professionals in the official announcement of the outbreak issued on December 31, 2019<sup>448</sup> a refrain that continued to appear in official statements, despite healthcare workers reporting illness after treating patients as early as December, 2019<sup>449</sup> until January 20, 2020 when the authorities acknowledged limited human-to-human transmission and 15 cases of healthcare workers in Wuhan who had contracted COVID-19.<sup>450</sup>

#### **d. Destruction of Early COVID-19 Viral Samples and Censorship of Information Related to COVID-19 Outbreak**

The PRC’s internet and social media censorship apparatus responded to the COVID-19 outbreak on **December 31**, 2019, the same day that Wuhan public health officials officially acknowledged the outbreak.<sup>451</sup> A retrospective study by researchers from the University of Toronto found that Chinese

social media platforms WeChat and YY added 45 terms to its national blacklist on December 31, 2019, all of which were related to the outbreak. The study noted that,

These keywords include factual descriptions of the flu-like pneumonia disease, references to the name of the location considered as the source of the novel virus, local government agencies in Wuhan, and discussions of the similarity between the outbreak in Wuhan and SARS. Many of these keywords such as “沙士变异” (SARS variation) are very broad and effectively block general references to the virus.<sup>452</sup>

The study detailed a selection of words that were blacklisted and censored on a national level beginning December 31, 2019:

Table 4. Chinese Language and English Translation of Censored Terms Relating to COVID-19

Language	Keyword	English Translation	Date Added
Simplified Chinese	武汉不明肺炎	Unknown Wuhan pneumonia	2019-12-31
Simplified Chinese	武汉海鲜市场	Wuhan seafood market	2019-12-31
Simplified Chinese	沙士变异	SARS variation	2019-12-31
Traditional Chinese	爆發sars疫情	SARS outbreak in Wuhan	2019-12-31
Simplified Chinese	武汉卫生委员会	Wuhan Health Committee	2019-12-31
Simplified Chinese	p4病毒实验室	P4 virus lab	2019-12-31

The term “P4 virus lab” is likely a reference to the WIV’s BSL-4 laboratory. P4 is the Chinese equivalent of BSL-4 and the WIV’s BSL-4 laboratory is the only one in Wuhan. Its inclusion on the list of censored terms on December 31, 2019 suggests that Chinese citizens may have already been speculating that the COVID-19 pandemic originated from a laboratory incident. At the time, other than select virologists with ties to China, people outside of Wuhan and the PRC were unlikely to be aware of the outbreak or know that Wuhan is home to a BSL-4 laboratory studying coronaviruses. The study concludes that Chinese social media companies “received official guidance on how to handle [the outbreak] as early as December 2019 when the spread of the disease was first made public.”<sup>453</sup>

On **January 1, 2020**, PRC authorities issued an order prohibiting medical professionals, academic researchers, and commercial biotechnology firms from sharing any information related to the outbreak of SARS-CoV-2, the nature of the virus, and other data, such as samples of the virus. Commercial genomic sequencing companies were targeted first because they had already processed sequencing results for hospitals in Wuhan in December, 2019. After several batches of genomic sequencing results had been returned to hospitals and submitted to the health authorities, an employee of one genomics company received a phone call from an official at the Hubei Provincial Health

Commission, ordering the company to stop testing samples from Wuhan related to the new coronavirus, and to destroy all existing samples, according to Chinese investigative journalists.<sup>454</sup>

On the afternoon of **January 1**, 2020, the Wuhan Municipal Public Security Bureau announced on its official Weibo account that it had “already investigated and dealt with eight rumormongers according to the law,”<sup>455</sup> who had “disseminated and reposted untruthful information online that caused a harmful effect on society.”<sup>456</sup> The local media, the Hubei Provincial People’s Government, and the Wuhan Municipal People’s Government all amplified the announcement on January 1, 2020. The People’s Daily, the official mouthpiece of the CCP, published an article on the morning of **January 2**, 2020 further highlighting the news that the rumormongers had been punished.<sup>457</sup> Later that same day, the state broadcaster CCTV also ran the report on its nationwide evening TV news segment.<sup>458</sup>

On **January 2**, 2020 Wang Yanyi, the director-general of the WIV, citing an order from the NHC, circulated a notice internally within the WIV that strictly prohibited the disclosure of any information related to the virus or the outbreak. It specified that nothing could be shared with any media, even state-run official media, or with “partner organization (including technical services companies).”<sup>459</sup>

On **January 3**, 2020 the order was applied nationally when the PRC National Health Commission (NHC) issued a classified directive on the management of biological samples during outbreaks of major infectious disease. The directive barred researchers, medical professionals, and others from publishing or sharing any information related to the virus without state authorization and ordered labs in possession of any relevant samples to transfer them to designated institutions or destroy them.<sup>460,461</sup> However, the order did not specify any designated testing institutions and the Committee was unable to identify any designated testing institutions.<sup>462</sup>

Public security officials summoned eight medical personnel responsible for leaking the relevant information online on **January 3**, 2020 including Dr. Li<sup>463</sup> – the day *after* they were lambasted by state and party media. Security officials questioned these whistleblowers at length and forced them to sign a self-confession for “spreading rumors” about the pneumonia outbreak, which they had accurately described as similar to SARS.<sup>464,465</sup> The mistreatment of Dr. Li and other whistleblowers was an example of the CCP using humiliation as a tactic to enforce elite conformity to its political edicts, even when such conformity violates their professional ethics and/or judgement.<sup>466</sup>

The matter was covered prominently by media outlets that are directly controlled by the CCP Central Propaganda Department based in Beijing, not in Wuhan. Moreover, this was the first, but not the last, known incident of punitive measures being taken against whistleblowers in Wuhan during the pandemic. Journalists, lawyers, and other concerned Chinese citizens who subsequently tried to document what was happening in Wuhan for the general public, such as Li Zehua, Chen Qiushi, Fang Bin, and Zhang Zhan, were all detained, disappeared, and/or sentenced to prison.<sup>467,468,469,470,471,472</sup>

On **January 25**, 2020 the Politburo Standing Committee meeting ordered the Cyberspace Administration of China (CAC) to “take the epidemic prevention and control work as your top political task at present... [and] use the power of the whole organization and the whole system do a good job with online propaganda and guidance work [related to] epidemic prevention and control...”<sup>473</sup> CAC’s goal in

curating online content was described in Orwellian terms as “forming unity of will into an impregnable stronghold” by “constructing a favorable atmosphere online.”<sup>474</sup>

Based on the University of Toronto study, by **February 10**, 2020, PRC social media censors removed many of the words censored on December 31, 2019 from their blacklists. This included terms like “Wuhan pneumonia epidemic” and “atypical pneumonia”<sup>475</sup>. However, the study found that references to the “Wuhan Virus Lab” were still censored.<sup>476</sup> Factual information about human-to-human transmission and the scale of the outbreak also remained censored. Further, Chinese social media sites censored most references, regardless of content, to the government’s response and PRC leadership throughout the study’s time period.<sup>477</sup>

On **February 24**, 2020, the PRC Center for Disease Control and Prevention (CDCP) took steps to prevent its researchers throughout the country from publishing data related to SARS-CoV-2 without pre-screening by central government officials.

As of the date of this report’s publication, PRC authorities still do not allow Chinese researchers to engage in the exchange of clinical samples or isolates of SARS-CoV-2. This prohibition appears to extend to related coronaviruses, such as RaTG-13. The Committee spoke with American experts with a history of collaborative research with the WIV who confirmed that the exchange of samples ceased after the SARS-CoV-2 outbreak. WIV coronavirus expert Shi Zhengli reportedly planned to share a sample with an American research partner at the Galveston National Laboratory, but officials in Beijing blocked her from doing so.<sup>478</sup> Shi’s February 3, 2020 article describing the similarity between RaTG-13 and SARS-CoV-2 was not approved by the Government of China and reportedly almost led to her arrest.<sup>479,480</sup>

#### **e. Failure to Recognize Role of Asymptomatic and Mildly Symptomatic Transmission**

On **January 24**, 2020 a team of doctors and researchers from Hong Kong published a piece in the *Lancet* that documented for the first time that SARS-CoV-2 was spreading asymptotically. The team was able to draw this conclusion based on their observation and treatment of a family of six patients, starting on January 10, 2020, who had travelled to Wuhan between December 29, 2019 and January 4, 2020. Five of the six family members tested positive for SARS-CoV-2 infection, including one 10-year-old child who was asymptomatic, but displayed radiological ground-glass lung opacities. None of the family members had contact with any markets or animals while in Wuhan, though two visited a hospital.

In contrast to other the other aspects of the PRC’s response to SARS-CoV-2 and the COVID-19 outbreak, PRC public health officials’ failure to recognize the critical role of asymptomatic and mildly symptomatic cases in spreading the virus is understandable. Asymptomatic spread is an unusual feature of SARS-CoV-2. The initial comprehensive epidemiological analysis of the COVID-19 outbreak published on February 10, 2020, China reported that only 1.2% of total COVID cases identified were asymptomatic.<sup>481,482</sup> The earliest studies indicating substantial asymptomatic spread of SARS-CoV-2 were not published until March and April, 2020.<sup>483</sup>

#### **f. Inaccuracy or Inconsistency of Date of First Acknowledged Confirmed Case of COVID-19**

Data initially published by the CCDC in mid-February 2020 indicated the first case of COVID-19 was on December 8, 2019. (Figure 24.)<sup>484</sup> A study later published in October 2020 using National Health Commission data in October 2020 indicates that the first confirmed COVID-19 case had the onset of symptoms on December 1, 2019. The implication of this earlier date of onset would imply that that patient likely contracted their COVID-19 illness in November. Based on the incubation period and range, their exposure may have been one to two weeks earlier. With a date range of between November 18 and 29, 2019.

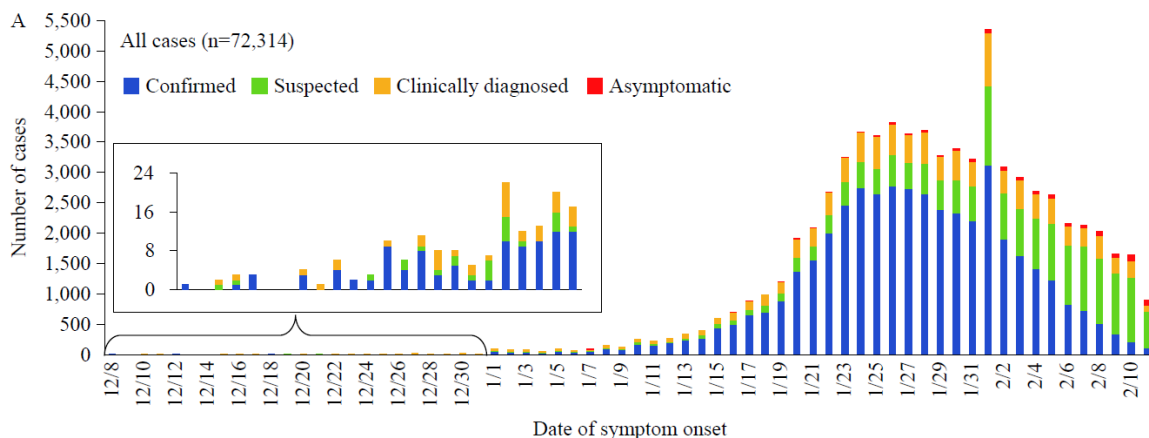

Figure 26. Epidemiological curves of COVID-19 in China through February 11, 2020. The epidemiological curve shows the progression of illness in the outbreak over time from December 8, 2019, to February 11, 2020. A total of 72,314 cases are shown and confirmed cases (blue) are compared to suspected cases (green), clinically diagnosed cases (yellow), and asymptomatic cases (red). The inset shows a zoomed-in view of all days in December, when total daily count remained below 24 cases. Source: CDC Weekly C. *The Epidemiological Characteristics of an Outbreak of 2019 Novel Coronavirus Diseases (COVID-19) — China, 2020. China CDC Weekly. 2020;2(8):113-122. <https://doi.org/10.46234/ccdcw2020.032>*

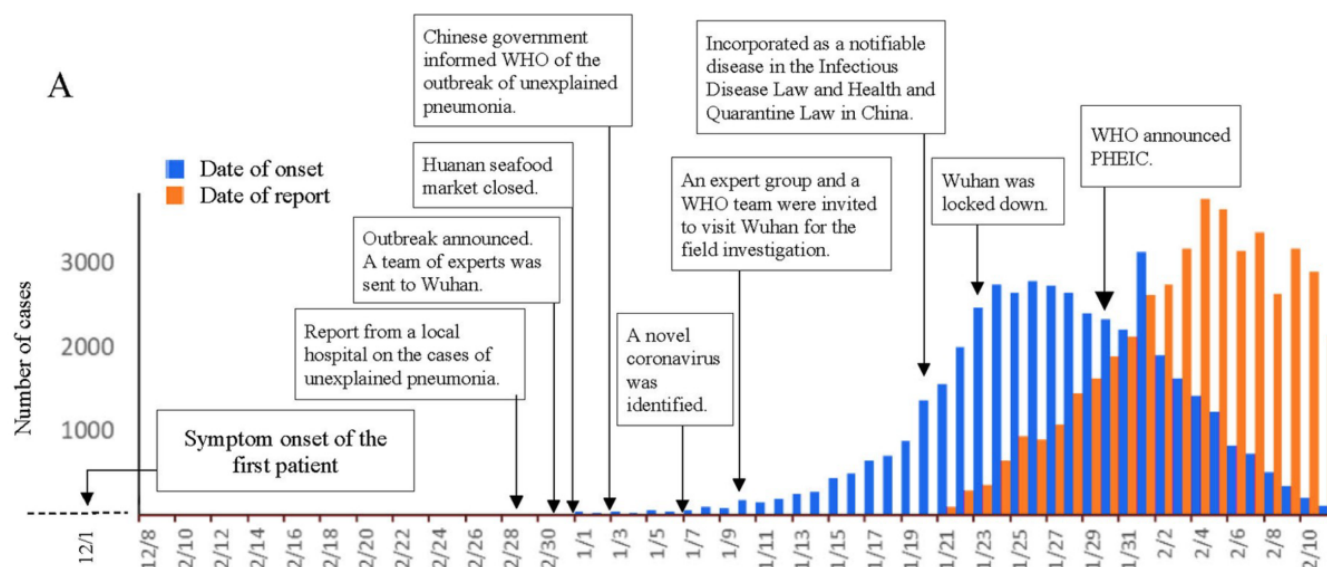

Figure 27. Timeline of the COVID-19 outbreak and official response. Only confirmed cases were analyzed referring to the report by The Novel Coronavirus Pneumonia Emergency Response Epidemiology Team in China.

Source: <https://journals.plos.org/plosntds/article?id=10.1371/journal.pntd.0008758>

## Chapter 4 : Precedent: Zoonotic Spillovers

















### Introduction:

A zoonotic spillover is the infection of a human by a virus that otherwise infects only animals, and which has not yet established ongoing circulation in human populations. These viruses can circulate in an original host animal population, or reservoir, and become adapted to a population of a different animal species, called an intermediate host, which comes into more regular contact with humans. The likelihood for a virus in animals to infect humans is determined by several factors. These include the intensity and scale of the infection in the infected animal population, the nature and frequency of human interaction with animals of the infected host or intermediate host population (such as through slaughter or insect bites), the preexisting immunity of potential human hosts, the ability of a pathogen to adapt to humans, and the ability of the pathogen to survive for a period of time outside of a host animal. With many preconditions for a zoonotic spillover, they are relatively rare events, and even when an individual is infected there is often no subsequent human-to-human transmission.<sup>485</sup>

Zoonoses are nevertheless originally responsible for most modern infectious diseases circulating in humans and comprise a large percentage of all newly identified infectious diseases.<sup>486</sup> They are the most common cause of newly emerging infectious diseases, with one estimate suggesting upwards of 70% of emerging infectious diseases between 1940 and 2004 originated in wildlife.<sup>487</sup> Some research also indicates that the peak frequency of known zoonotic spillovers in recent history was in the 1980s.<sup>488</sup>

In nearly all modern zoonotic spillovers, virologists and epidemiologists have successfully identified the original host species, or reservoir, and intermediate host species. Virologists have also been able to identify likely animal origins for many pathogens which have circulated in humans for centuries, such as leprosy and tuberculosis. Other examples include identification of the host or reservoir species of HIV, Ebola, Nipah, and SARS and MERS viruses, the latter two of which are related to SARS-CoV-2. However, in many of these cases, identification of the host species took many years. The 2003-04 SARS outbreak was determined in a short period of time to be proximally from masked palm civets. After additional investigation, horseshoe bats were found to be the reservoir species from which masked palm civets became infected.

## Comparing COVID-19 Pandemic to Past Select Viral Zoonotic Outbreaks

	Location of Emergence	Asymptomatic Infection Common	Reservoir Species and Year Identified	Probable Intermediate Species and Year Identified
<b>COVID-19</b> (2019–Present)	China	 Yes	 Unknown	 Unknown
<b>Ebola</b> (2014–16)	Guinea	 No (Probably)	 Bats (Probably); N/A	 Nonhuman primate (Probably); N/A
<b>MERS</b> (2012)	Saudi Arabia, Jordan	 Yes	 Bats (Probably); N/A	 Dromedary camels; 2013
<b>SARS</b> (2002–04)	China	 No (Probably)	 Horseshoe bats; 2016	 Masked palm civets and Raccoon dogs (Possibly); 2003
<b>Nipah</b> (1998–99)	Malaysia	 Yes	 Fruit bats; 1999	 Pigs; 1998
<b>HIV-1<sup>a</sup></b> (1970s–Present)	Democratic Republic of Congo (Probably)	 No (Probably)	 Chimpanzees (Probably); 1999	N/A

*a. HIV is believed to have crossed from chimpanzees to humans in the 1920s; the first documented death occurred in the late 1960s.*

Figure 28. Chart from declassified report by Office of the Director of National Intelligence: Updated Assessment on COVID-19 Origins. Source: <https://www.dni.gov/index.php/newsroom/reports-publications/reports-publications-2021/item/2263-declassified-assessment-on-covid-19-origins>

China has historically been a hotbed for pandemics. This is not necessarily surprising given its large population and dense, highly developed cities, which in some instances date back centuries. The 14<sup>th</sup> century bubonic plague pandemic known as the “Black Death” is believed to have originated in China as did the much less deadly 19<sup>th</sup> century bubonic plague pandemic.<sup>489</sup> The most recent plague outbreak occurred in Yunnan Province from 1986 to 2005 with a brief reemergence there in 2016.<sup>490</sup> At least, 3 of 5 influenza pandemics during the 20<sup>th</sup> century (1957 “Asian flu”, 1968 “Hong Kong flu”, and 1977 “Russian flu”) are also thought to have originated from China.<sup>491</sup> There is an increasing body of evidence indicating that the 1918 Spanish flu may have originated from China. Since its founding at the end of Chinese Civil War, the PRC has made the control of infectious diseases a domestic policy priority.<sup>492</sup>

The frequency, mechanisms, and circumstances leading to human infection by previously exclusively animal viruses provides a point of comparison for the available epidemiological data around the emergence of COVID-19.



## 1. 2002-2004 SARS Epidemic

Severe Acute Respiratory Syndrome (SARS) was a major epidemic of the 21<sup>st</sup> century. Before SARS, coronaviruses were known to cause 30-35% of cases of the common cold but were not considered a potential pandemic threat. During 2003, the disease spread quickly from southern China to Hong Kong and Beijing with transmission being disproportionately driven by super spreading events.<sup>493</sup> From Hong Kong, SARS spread to over 24 countries, predominately in the Asia Pacific, although Canada and other countries also experienced many cases.<sup>494</sup>

Before it was brought under control the SARS epidemic infected over 8,000 people, killing 774.<sup>495</sup> Healthcare workers treating infected individuals were particularly impacted by the disease. The economic damage wrought by SARS was estimated at \$80 billion dollars.<sup>496</sup> The SARS epidemic was also a domestic political crisis for the PRC and an international embarrassment for its leadership. In the aftermath of the epidemic, the PRC initiated reforms that improved its ability to detect, respond to, and control outbreaks of infectious diseases that have proven effective in the years since SARS.

### a. Outbreak and Response by PRC

The earliest known case of Severe Acute Respiratory Syndrome (SARS) is believed to date from mid-November, 2002 in Foshan, a city near Guangzhou the capital of Guangdong Province in Southern China, when a hospitalized patient was diagnosed with a case of “atypical pneumonia.”<sup>497</sup>

Similar cases of atypical pneumonia were diagnosed in the cities of Heyuan and Zhongshan in neighboring Guangdong Province between mid-November, 2002 and mid-January, 2003.<sup>498</sup> At the time, pneumonia was not a mandatory reportable infectious disease in China.<sup>499</sup> Nevertheless, frontline Chinese clinicians responded quickly to the outbreak, reporting it to local public health officials in mid-December, 2002.<sup>500</sup>

On January 20, 2003 officials from the Guangzhou Provincial Health Ministry took over the response to the outbreak and initiated an investigation into its origins.<sup>501</sup> The report of their origins’ investigation was marked top secret and shared only with the Provincial and national Health Ministry in Beijing.<sup>502</sup> Other countries and the WHO were not notified.<sup>503</sup> No public announcements of the outbreak or public health advisories were issued. Then as now, PRC’s State Secrets Law treats public health information related to the outbreak of an infectious disease as a state secret:

[A]ny occurrence of infectious diseases should be classified as a state secret before they are “announced by the Ministry of Health or organs authorized by the Ministry”... [U]ntil such time as the Ministry chose to make information about the disease public, any physician or journalist who reported on [SARS] would risk being persecuted for leaking state secrets.<sup>504</sup>

As a result, “a virtual news blackout about SARS” continued into February, 2003.<sup>505</sup> Guangdong health authorities did not author a standard case definition or begin surveilling for the virus. Nor did they issue guidance for preventing the spread, the use of personal protection, or invoke quarantine for case

contacts until late March 2003.<sup>506</sup> Guangdong provincial authorities did not institute travel restrictions or border controls until mid-April.<sup>507</sup> During this period of secrecy and inaction, the virus spread to Hong Kong and from there to Singapore, Vietnam, and Canada.<sup>508</sup> On February 10, 2003, the World Health Organization (WHO) was alerted via an email by a former employee of a contagious disease in Guangdong that had already killed 100 people.<sup>509</sup>

On February 11, 2003, the Chinese Ministry of Health issued its first public report that 305 people had been infected with atypical pneumonia. On February 12, 2003, WHO formally requested more epidemiological information and China responded two days later that the outbreak was under control and that the outbreak was ebbing in some cities.<sup>510</sup> At this time senior Guangdong health officials were claiming that the outbreak was due to a bacterial pathogen, chlamydia.<sup>511</sup>

WHO followed up with Chinese officials on February 20, 2003 offering to send experts to Guangdong province to investigate the outbreak, but PRC officials declined the offer.<sup>512</sup> On February 26, the Chinese Academy of Military and Medical Sciences in Beijing identified a coronavirus from clinical samples, the samples were not shared with international partners.<sup>513</sup> The WHO would not get viral samples of the unknown disease until March 3 when a WHO physician in Hanoi, Vietnam took samples from a patient and sent serum and throat swabs to laboratories in Tokyo, Atlanta, and Hanoi.<sup>514</sup>

The outbreak spread to Beijing on March 5, 2003 while the Chinese Communist Party was preparing for the National People's Congress to meet later that month in order to choose a new president and premier. In late March, China authorities publicly updated the case numbers from 305 to 792 cases and from 5 deaths to 31.<sup>515</sup> The cumulative, global reported cases on March 30 was 1,622, with 58 deaths.<sup>516</sup> There were also significant political events taking place in Beijing in March 2003. President Hu Jintao who had been named the leader of the Chinese Communist Party in the fall of 2002 was announced President of China in March 2003.

On April 2, 2003, WHO received permission from PRC authorities to send a team to Guangdong province.<sup>517</sup> WHO's team visited hospitals throughout southern China and in Beijing a few weeks later and experienced varying degrees of collaboration and transparency. On April 9, a prominent surgeon and former hospital director for the People's Liberation Army (PLA), Dr. Jiang Yanyong, disputed the official count of 19 SARS patients in Beijing.<sup>518</sup> Dr. Jiang disclosed that there several cases at PLA hospitals that were not being reported. He circulated a letter to international news organizations that Beijing was not transparent about the outbreak's true severity.<sup>519</sup> The PLA detained Dr. Jiang following his actions.<sup>520</sup> In mid-April, Beijing officials were reporting 34 cases, an implausibly low number that the WHO refused to accept as correct.

On April 12, 2003, PRC Premier Wen Jiabao admitted at a press conference that the SARS outbreak is "grave" and pledges transparency going forward from PRC government officials.<sup>521</sup> On April 23, PRC leadership began to publicly release more information on the outbreak. PRC officials admitted there were more than 200 undisclosed SARS patients in PLA hospitals in Beijing alone.<sup>522</sup> In an effort to show that it was taking the epidemic seriously, PRC leadership dismissed the national health minister and the mayor of Beijing while announcing that the Ministry of Health would handle the SARS outbreak in the capital.<sup>523</sup>

On April 22, 2003, PRC government officials allow WHO experts to develop containment measures to prevent the spread of SARS. On April 23, Beijing suspends schools for two weeks. On April 30, 2003, PRC officials begin to institute travel screening. Through the late spring of 2003, Beijing was taking dramatic steps to contain the virus.<sup>524</sup> Government officials instituted and enforced isolation, contact tracing, and quarantine. These measures resulted in a rapid decline in cases with Guangdong reporting no new SARS cases after May 17, 2003. Beijing was declared SARS free on June 24. From late-June 2003 through April 2004, China reported only isolated, sporadic cases of SARS. For example, there was an outbreak of four cases in late-December 2003 through January 2004 of four cases in Guangdong Province associated with a restaurant selling live palm civets. There are also at least three outbreaks associated with SARS research during this period.

Before the SARS epidemic was controlled, it had infected 8422 patients in 29 countries, killing 916 patients. SARS was a serious test for PRC leadership.<sup>525</sup> The failure of provincial and national government agencies to mount an early, effective, and timely response allowed the outbreak to grow into a pandemic. It was not until April 2, 2003, that the senior national leadership of the PRC issued directives to act against the outbreak.<sup>526</sup>

One expert has speculated that “it is likely that [PRC and CCP] leaders were so pre-occupied preparing for the National People’s Congress” that they failed to provide direction to lower level officials.<sup>527</sup> This in turn likely paralyzed provincial and municipal authorities.<sup>528</sup> The PRC’s response was further inhibited by “obstructions of information flow and the lack of interdepartmental cooperation” between national, provincial, municipal, and military officials.<sup>529</sup> Even once SARS was being taken seriously by senior leadership, information flow and competing incentives complicated the PRC’s response:

By early April [2003], it was evident that SARS was being taken very seriously at the top level. Yet the government’s ability to formulate a sound policy against SARS was hampered as lower-level government officials intercepted and distorted the upward information flow. For fear that any mishap reported in their jurisdiction might be used as an excuse to pass them over for promotion, government officials at all levels tended to distort the information they pass up to their political masters in order to place themselves in a good light.

Despite increased openness and a highly visible public health emergency response, throughout the pandemic PRC authorities censored the press and misled its citizens.<sup>530</sup> The state media reported that the virus was a rumor and there was no outbreak.<sup>531</sup> Once forced to admit that there was an outbreak, government officials and state media, continued to insist that the outbreak was under control.<sup>532</sup> PRC authorities threatened its citizens with criminal prosecution for spreading rumors about SARS on the internet.<sup>533</sup>

From April through July 2003, Chinese authorities arrested people for sending messages about the disease, removed newspaper editors for their publications, censored television interviews, and blocked the distribution of publications.<sup>534,535</sup> The U.S. Congressional-Executive Commission on China published

a report following the epidemic that concluded that China's suppression of free reporting of the SARS outbreak interfered with the WHO's ability to detect the SARS outbreak because the organization's Global Public Health Information Network relies on monitoring media reports about outbreaks.<sup>536</sup> That commission also found that criticism of the Chinese government's response was limited to local government with the central government was depicted in heroic terms.<sup>537</sup>

During the SARS pandemic, the desire of PRC leadership to maintain social stability, particularly during the period of a leadership transition, and culture of bureaucratic secrecy prevented a timely response to the crisis. Only growing domestic and internal pressure pushed PRC officials to partial transparency about the scale of the outbreak and to take measures necessary to bring SARS under control. In order to bring the pandemic to an end, PRC officials implemented highly disruptive quarantines, travel prohibitions, and other public health measures.<sup>538</sup> Foreign government also imposed travel restrictions on Chinese cities. China's international standing was negatively impact and its economy billions in SARS-related losses. The failures in the PRC's response would spur reforms to China's public health and infectious disease surveillance, but few changes to its political system, including its censorship regime and tendency for secrecy.

#### **b. Investigating the Origins of SARS**

Efforts to understand the origins of SARS began shortly after PRC leadership publicly announced that SARS was a major public health risk and started to mobilize the Chinese people to combat the pandemic in February 2003. Unlike the 2020 investigation into SARS-CoV-2's origins, the PRC's investigation into the origins of SARS in 2004-2005 was able to quickly identify the zoonotic origins of SARS and the likely intermediate host species. Retrospective case identification work conducted in 2003-2004 as part of the epidemiological investigation into the origins of SARS quickly determined that many the earliest cases were associated with animal handlers:

Between November 2002 and February 2003, the first cases or clusters of SARS appeared in several independent geographic locations in the Pearl River Delta region in southern Guangdong and suggested multiple introductions of a virus or similar viruses from a common source. Several of the early cases were reportedly associated with occupations that involved contact with wildlife, including handling, killing and selling wild animals as well as preparing and serving wildlife animal meat in restaurants... Moreover, a study of early SARS cases (i.e. those with disease onset prior to January 2003) compared to those identified later in the outbreak found that 39% of early-onset cases were food handlers, whereas only 2%–10% of cases between February and April 2003 were associated with this occupation. Also, early-onset cases were more likely to live within walking distance of animal markets than late onset cases.<sup>539</sup>

This association suggested that SARS had a zoonotic origin, that the virus was an animal virus that spilled over into humans rather than a pre-existing human virus that had evolved increase transmissibility or pathogenicity. Additional retrospective case identification, coupled with seroprevalence studies showed, "that early cases of SARS occurred independently in at least five different well-separated municipalities in Guangdong Province" further suggesting a zoonotic origin.<sup>540</sup>

Investigators also discovered at least four SARS patients with infections during isolated outbreaks in 2004 did not have contact with an existing SARS case, but all four had previous exposures to live animals.<sup>541</sup> (Figure 29)



Figure 29. SARS outbreaks in Guangdong Province, People's Republic of China. The geographic distribution of SARS outbreak in Guangdong [Province] Nov 16, 2002, to Feb 9, 2003. Number of cases are shown in brackets. Approximate dates of the onset of the outbreaks for each city were Foshan, Nov 16, 2002; Heyuan, Dec 17, 2002; Zhongshan, Dec 26, 2003; Guangzhou, Jan 31, 2003; Jiangmen, Jan 10, 2003; Shenzhen, Jan 15, 2003. Source: Zhong, N. S., Zheng, B. J., Li, Y. M., Poon, Xie, Z. H., Chan, K. H., Li, P. H., Tan, S. Y., Chang, Q., Xie, J. P., Liu, X. Q., Xu, J., Li, D. X., Yuen, K. Y., Peiris, & Guan, Y. (2003). Epidemiology and cause of severe acute respiratory syndrome (SARS) in Guangdong, People's Republic of China, in February 2003. *Lancet (London, England)*, 362(9393), 1353–1358. [https://doi.org/10.1016/s0140-6736\(03\)14630-2](https://doi.org/10.1016/s0140-6736(03)14630-2)

### i. Identifying the Intermediate Host of SARS

A survey of 508 wet market workers in Guangdong Province revealed that 13% of wild animal traders tested positive for SARS antibodies with 72% of palm civet traders testing positive for antibodies.<sup>542</sup> By contrast only 5% of vegetable traders had SARS antibodies.<sup>543</sup> None of the animal traders who tested positive for SARS antibodies reported being sick, suggesting either asymptomatic transmission or exposure to a less severe virus closely related to SARS.<sup>544</sup>

In May 2003, less than six months after the first known SARS cases, public health investigators sampling animals in live animal markets in the city of Shenzhen, located approximately 75 miles from Guangzhou, found that three of six sampled palm civets tested positive for SARS as did the only raccoon dog tested.<sup>545</sup> Two Chinese Ferret Badgers at the market also tested positive for SARS antibodies. The virus collected from the animals was 99.8% similar to SARS.<sup>546</sup> “These data indicated that at least three

different wildlife animal species in the Shenzhen market were infected by a coronavirus that is closely related to SARS” and was the “first direct evidence that [SARS] existed in animals”.<sup>547</sup>

Critically, for the purposes of determining whether raccoon dogs and civets were the intermediate host species that introduced the virus into humans, the virus collected from palm civets and raccoon dogs contained a 29 nucleotide sequence only found in the earliest human SARS cases.<sup>548</sup> Taken together, this evidence suggests that SARS likely crossed the species barrier from palm civets or raccoon dogs into humans with the 29 nucleotide sequence dropping out as SARS adapted to humans.

As a result of the Shenzhen market survey, public health investigators conducted serological studies of palm civets at animal farms and live animal markets throughout China. These studies were aided by the mass culling of palm civets undertaken by government officials in an effort to stop the spread of SARS as it provided investigators with a large number of animal samples to examine and test. However, investigators struggled to find evidence of SARS infected palm civets in animal farms. For example, one serological study found that none of the 108 samples taken from palm civets at live animal farms tested positive for SARS.<sup>549</sup> By contrast, 14 of 18 samples collected from palm civets in animal markets in Guangdong tested positive.<sup>550</sup> In another study, the majority of 91 palm civets and 15 racoon dogs taken from a Xinyuan animal market tested positive for SARS.<sup>551</sup> However, in the same study, none of the 1,107 palm civets sampled from “25 farms in 12 province” were positive from SARS.<sup>552</sup> The prevalence of SARS infections among palm civets located in live markets, coupled with the absence of infected palm civets at animal farms suggested palm civets were an intermediate host for SARS, not the reservoir host.

In December 2005, the role of palm civets as an intermediate host of SARS was confirmed when an investigation of a SARS outbreak at a restaurant found that virus samples taken from infected humans were identical to virus sample taken from palm civets at the restaurant.<sup>553</sup> Moreover, both the human and palm civet samples were more closely related to the variant of SARS containing the 29-nucleotide sequence than later human adapted variants.<sup>554</sup> As a result, epidemiologists concluded that:

Taken together, the lack of widespread infection in wild or farmed palm civets and the display of overt clinical symptoms following experimental infection suggest that palm civets are unlikely to be the natural reservoir of [SARS]. Instead, the animal’s high susceptibility to [SARS] and its wide distribution in markets and restaurants made it an ideal amplifying [intermediate] host that is believed to have played an important role in both the major 2002–2003 and sporadic 2003–2004 outbreaks.<sup>555</sup>

## **ii. Identifying the Viral Reservoir of SARS**

Prior to the 2002-2003 SARS pandemic, bats were recognized as viral reservoirs for several zoonotic viruses. They were known to be susceptible to infections and to respond asymptotically to many viral infections. Bats were not known to be a viral reservoir for coronaviruses. In the wake of the SARS pandemic, a 2004 study sampled 408 bats across nine species from Guangdong, Guangxi, Hubei, and Tianjin Provinces. A high percentage of the three species of horseshoe bats (*Rhinolophus* bats) sampled had SARS antibodies. “Genome sequence analysis indicated that SARS-related coronaviruses

(SL-CoVs) present in bats have an almost identical genome organization to those of [SARS] isolated from humans or civets, sharing an overall sequence identity of 92%.”<sup>556</sup> A further study found that approximately 84% of horseshoe bats sampled contained SARS antibodies.<sup>557</sup> The discovery in 2005 that a substantial percentage of bats from a variety of horseshoe bat species contained SARS-related viruses, was “consistent with bats being the wildlife reservoir host for” SARS-related coronaviruses.<sup>558</sup>

By 2005, the discovery of a large number of genetically diverse SARS-related viruses in multiple species of horseshoe bats, led scientists to conclude that SARS “originated in horseshoe bats with civets acting as the intermediate amplifying and transmitting host.”<sup>559</sup> However, efforts to locate the direct descendant of SARS, or progenitor virus, in bats were unsuccessful in the years following the pandemic.<sup>560</sup> Specifically, researchers were unable to find a SARS-related virus sufficiently similar to SARS that also used ACE2 receptors as its mechanism for cellular entry.<sup>561</sup> As general scientific interest in coronaviruses ebbed, Chinese researchers continued to conduct large scale viral prospecting exhibitions to Southern China and South East Asia.

In 2013, a team of WIV researchers conducting a one year (April 2011 to September 2012) longitudinal survey of SARS-related coronaviruses in a single habitat in Kunming, Yunnan Province, made a breakthrough discovery. The researchers collected 117 samples from individual bats of which 27 tested positive for the presence of a coronavirus.<sup>562</sup> Among the positive samples, researchers identified a total of seven different coronavirus strains circulating in this single bat colony. Most importantly, the researchers discovered two novel SARS-related coronaviruses, RsSHC014 and Rs3367, had a 95% similarity to SARS at the whole genome level.<sup>563</sup> The two viruses were more closely related to SARS than any other previously discovered virus.

From the samples, the WIV team was also able for the first time to isolate a live SARS-related virus that was 99% similar to Rs3367. Experiments with this live virus sample, named bat SL-CoV-WIV1 (WIV1), determined that like SARS, WIV1 used ACE2 as a cellular entry receptor and could directly infect human cells.<sup>564</sup> Researchers would also create a chimeric virus by grafting the RsSHC014 to a mouse-adapted SARS “backbone.” This chimeric virus also used ACE2 as a cellular entry receptor and could directly infect human cells. In July 2013, the WIV team of researchers successfully isolated a second bat coronavirus from a sample taken from the Yunnan bat colony named bat SL-CoV WIV16 (WIV16).<sup>565</sup> WIV16 supplanted WIV1 as the closest known virus to SARS at the time of its discovery. WIV16 could also use ACE2 as an entry receptor, including for human cells.

In 2017, the same group of researchers would publish the results of a five year (April 11 to October 2015) longitudinal study on the same bat cave as the 2011-2012 study. By October 2015, researchers had taken 602 bat samples with 84 samples testing positive.<sup>566</sup> In total the study found 15 novel bat coronaviruses in a single cave. By comparing sections of these viruses to SARS, the researchers concluded, “all of the building block” SARS’s genome could be found in the 15 SARS-related coronaviruses found in the cave. Moreover, the viruses were sufficiently similar and present in sufficient density that recombination events were a likely occurrence, thus increasing the probability that SARS emerged from this specific cave in Yunnan Province. It took researchers approximately 14 years from the first outbreak of SARS to locate its viral reservoir in a Yunnan Province cave home to multiple species of horseshoe bats.

### iii. Identifying SARS's Emergence Pathway

How SARS traveled approximately 800 miles from its viral reservoir in an isolated cave in rural Yunnan Province to Guangzhou in neighboring Guangdong Province is still not fully understood. At some point, an infected bat had to encounter a palm civet. However, as discussed, palm civets sampled from animal farms in multiple Chinese provinces tested negative for the virus or antibodies. By contrast, palm civets collected from multiple wet markets across southern China tested positive. Similarly, the earliest identified SARS cases, while all having recent exposure to live animals, were otherwise unrelated to one another, suggesting multiple independent zoonotic introductions of the virus across several live animal markets. In addition to palm civets and other small mammals, wet markets in Southern China also sell live bats, including various species of horseshoe bat.

Collectively, this evidence suggests that palm civets were infected from bats somewhere in the South China wet market supply chain, such a warehouse, while in transit, or at wet markets. Stressed animals stored in dense and unhygienic conditions shed large amounts of viruses. “The main source of cross-species transmission in the animal trading chain (including warehouses, transportation vehicles, markets) may come from contaminated feces, urine, blood, or aerosols.”<sup>567</sup> Moreover, cages at wet markets are often stacked on top of each, further facilitating cross-species transmission of viruses.<sup>568</sup>

“The conditions the live animals are subjected to in wet markets create a petri dish for the spread of diseases.” As one group of Hong Kong based researchers described, “the presence of a large reservoir of SARS-CoV-like viruses in horseshoe bats, together with the culture of eating exotic mammals in southern China, is a time bomb.” Based on the available evidence, the most likely emergence pathway for SARS was that multiple horseshoe bats infected with SARS progenitor virus were captured by live animal traders in Yunnan Province and infected palm civets, and likely other mammals, the live animal market supply chain.

## 2. Post-SARS Reforms in China's Public Health System and Infectious Disease Surveillance

### a. Public Health and Infectious Disease Surveillance Reforms

The SARS pandemic “caused the most severe socio-political crisis for the Chinese leadership since the 1989 Tiananmen crackdown.”<sup>569</sup> In response, China carries out significant reforms to its public health system. The PRC created a network of Centers for Disease Control at the district, provincial, and national level. The CCDCs are modeled after the U.S. CDC and in the years following the SARS epidemic, the United States and other countries helped China build capacity in it's in public health system.<sup>570</sup> Funding for public health departments increased as did public-sector health care spending.<sup>571</sup> The CCDC alone received \$850 million in new funding as part of its restructuring.<sup>572</sup>



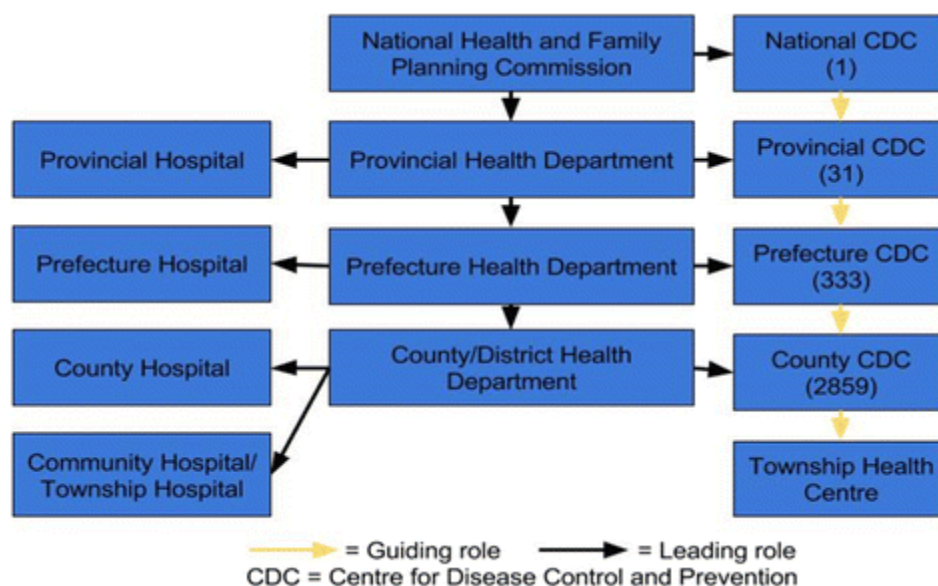

Figure 30. Organization of Chinese public health organizations involved in infectious disease control. Source: Vlieg, W. L., Fanoy, E. B., van Asten, L., Liu, X., Yang, J., Pilot, E., Bijkerk, P., van der Hoek, W., Krafft, T., van der Sande, M. A., & Liu, Q. Y. (2017). Comparing national infectious disease surveillance systems: China and the Netherlands. *BMC public health*, 17(1), 415. <https://doi.org/10.1186/s12889-017-4319-3>

The SARS epidemic also brought about significant changes to infectious disease surveillance and reporting. PRC officials added viral pneumonia and SARS as reportable diseases. The PRC implemented new infectious disease surveillance systems, including Notifiable Infectious Disease Reporting Information System (NIDRIS) the world's largest internet-based disease reporting system.<sup>573</sup> In 2008, the CCDC also created China Infectious Diseases Automated-Alert and Response System (CIDARS), an automated surveillance system for infectious disease outbreaks that scans cases registered in NIDRIS.<sup>574</sup>

CIDARS divided 33 infectious diseases into two tiers with the more severe type 1 diseases using a fixed threshold number of cases to trigger a warning.<sup>575</sup> SARS is a type 1 infectious disease and only a single reported case is required to generate a warning signal in CIDARS.<sup>576</sup> The warning signal is sent to the District or County Level (Local) CDC where "local epidemiological surveillance staff will immediately perform initial verification of the signals, including logging onto the disease surveillance system to view the information of the cases, comparing against surveillance data from other sources, and verifying with the reporting agency or patients via phone calls, etc."<sup>577</sup> Case information will include a patient's demographic information, date of onset, date of reporting, occupation, and residential address.<sup>578</sup>

If Local CDC personnel verify the warning signal as a suspected infectious disease, they complete a Signal Verification Card reporting the infectious disease suspected, number of cases, method of verification, and other relevant information. The Signal Verification Card is sent to Provincial and National CCDCs.<sup>579</sup> Local CCDC personnel then begin a field investigation into the suspected outbreak. CIDARS detected 56 warning signals for SARS during 2011-2013. In keeping with CIDARS single case threshold, each SARS warning signal triggered a CCDC response with a median response time of 30 to fifty minutes.<sup>580</sup> None of the SARS warning signals were confirmed as SARS infections. During the same time period, CIDARS received 760 warning signals for unexplained pneumonia. Similar to SARS, almost

every warning signal triggered a response (97.6% to 100% annually) and response time was reported at approximately 30-40 minutes.<sup>581</sup>

In preparation for the 2008 Olympic Beijing Games, public health officials launched an Olympics specific infectious disease surveillance and early warning system.<sup>582</sup> The system used 125 sentinel hospitals who were required to report within 4 hours if they received a certain number of patients with specific symptoms.<sup>583</sup> Among other data, the system's surveillance record card included a patients' demographic information, place of business, residence, phone numbers, relevant symptoms, symptom onset date, and close contacts for the past three days.<sup>584</sup>

Record card for SSSBOG in sentinel hospitals during Olympic game	
1. Name:	_____
2. Gender:	Male or Female
3. Age:	_____ Years of Age
4. Workplace:	_____
5. Residence Address:	_____
6. Telephone No.:	_____
7. Mobile Phone No.:	_____
8. Close Contact:	
Fever Cases 3 and Above	Yes or No
Diarrheal Cases 3 and Above	Yes or No
Jaundice Cases 2 and Above	Yes or No
Rash Cases 2 and Above	Yes or No
Conjunctival Redness Cases 3 and Above	Yes or No
9. Onset Time:	___ yy ___ mm ___ dd
10. Reporter:	_____
11. Report Date:	___ yy ___ mm ___ dd
12. Report Agency:	_____

Figure 31. Record card for SSSBOG in the whole city during 29<sup>th</sup> Beijing Olympic Games. Source: Pang, X., Wang, X., Wang, Q., Gao, T., & Li, X. (2017). Infectious Disease Surveillance and Early Warning System During Beijing Olympic Games. *Early Warning for Infectious Disease Outbreak*, 163–180. <https://doi.org/10.1016/B978-0-12-812343-0.00008-4>

By 2009, post-SARS public health surveillance reforms enabled real-time case-based reporting of infectious disease outbreaks:

With case-based information, health officials can immediately identify the nature and location of a particular disease outbreak; the characteristics of clusters of cases (e.g., age, sex, occupation); and (using geographical information system technology) the precise geographical location of the outbreak, down to specific village and households. The use of this system has increased the completeness of reported data.<sup>585</sup>

In addition to NIDRIS and CIDARS, China has two disease specific early warning systems. One is a hospital-based sentinel surveillance system for influenza like illness (ILI) that, as of 2013, uses a network of 500 hospitals across 31 provinces to monitor for reported cases of influenza.<sup>586</sup>

The second is a pneumonia of unexplained etiology (PUE) surveillance system, built in direct response to the 2003 SARS epidemic.<sup>587</sup> Officially, the PUE surveillance systems operate on hair trigger, notifying public health officials if there is a single reported case:

All Chinese health care facilities are required to report patients who have a clinical diagnosis of pneumonia with an unknown causative pathogen and whose disease meets the five criteria of pneumonia diagnosis to the PUE system. Such cases are also entered into NIDRIS. Once a PUE case is registered in NIDRIS, the data are further analyzed in CIDARS as a (possible) type 1 disease.<sup>588</sup>

A 2013 study by CCDC researchers suggests that the PUE surveillance network has problems with under reporting of cases by clinicians and a reporting bias in favor of provinces where avian influenza is a regular occurrence.<sup>589</sup> One explanation for the reported underutilization of PUE surveillance is that lack of SARS infections prior to the outbreak of COVID-19, which resulted in the PUE surveillance system mostly being used to supplement ILI surveillance for avian influenza.<sup>590</sup>

NIDRIS and CIDARS are also believed to suffer from under reporting of cases.<sup>591</sup> Under reporting may also be exacerbated by the widespread use of village and neighborhood clinics to treat mild illness. Despite legal obligations to report notifiable diseases, these small clinics are unlikely to do so consistently.<sup>592</sup> As a general matter, Chinese utilize hospitals at a lower rate their western peers, in part because of concerns for the cost of medical treatments.<sup>593</sup> Perhaps in an effort to compensate for the lack of uniform, complete reporting, CIDARS “is built to be sensitive and effective” but as a result the system contains “false positives and the sheer amount of [warning] signals distributed make using it a challenge.”<sup>594</sup> Ultimately, CIDARS goal is “not to detect each unexplained pneumonia case but to focus on clusters that could indicate an (unknown) emerging infectious disease outbreak.”<sup>595</sup>

Despite these reforms, public health experts have expressed concerns about the PRC’s public health systems inadequate funding and difficulty recruiting and retaining qualified personnel. “China has consistently decreased its investments in public health, including preparedness and response, over the past decade.”<sup>596</sup> The CCDC’s budget in 2019 was \$40 million down from a 2017 high of \$157.5 million.<sup>597</sup> The In 2016 the CCDC had 2,120 full time staff compared to 11,195 at the U.S. CDC.<sup>598</sup> Municipal and Provincial CDCs also suffer from inadequate budgets and low pay.<sup>599</sup>

## **b. Animal Surveillance and Veterinary Infectious Disease Control Reforms**

Immediately following the end of the SARS epidemic, China began experiencing outbreaks of highly pathogenic avian influenza (HPAI) A H5NI (H5N1) in its poultry farms and live poultry markets as the virus spread from Vietnam and Thailand to other Asian countries.<sup>600</sup> “In the years 2004–2008, over 100 outbreaks in domestic poultry occurred in 23 provinces and caused severe economic damage to the poultry industry in China.”<sup>601</sup> Mass culling couple with a large scale chicken vaccination campaign helped bring down the number of outbreaks. However, an estimated 35,420,000 poultry were culled in the process.<sup>602</sup>

Along with the role of live animals' sales in spurring the SARS epidemic, reoccurring outbreaks of H5N1 in poultry as well periodic cases of human infections have driven reforms of the PRC's animal infectious disease surveillance systems and animal health. Beyond SARS and H5N1, China's agricultural sector has experienced several large outbreaks of animal diseases. Notable diseases include avian influenza A H7N9 in birds. African swine fever virus (ASFV), porcine reproductive and respiratory syndrome virus (PRRSV), porcine epidemic diarrhea virus (PEDV), and foot-and-mouth disease virus (FMDV) have all broken out in China's pork industry, with several becoming endemic.<sup>603</sup> Collectively these viruses have caused billions of dollars in economic loss to China's pork industry, which accounts for almost 60% of the world's pork production.<sup>604,605</sup>

Animal infectious disease surveillance in China is the responsibility of the Ministry of Agriculture's Veterinary Bureau, and the China Animal Disease Control Center (CADCC).<sup>606</sup> Since 2007, each county, district, municipality has had to establish its own CADCC.<sup>607</sup> While disease outbreaks in animal populations continue, there are signs that these reforms and the creation of CADCCs have yielded positive results. There have been sharp reductions in H5N1 and H7N9 influenza rates among poultry attributable to vaccination campaigns and improved surveillance allowing for timely culling of infected and exposed animals.<sup>608</sup>

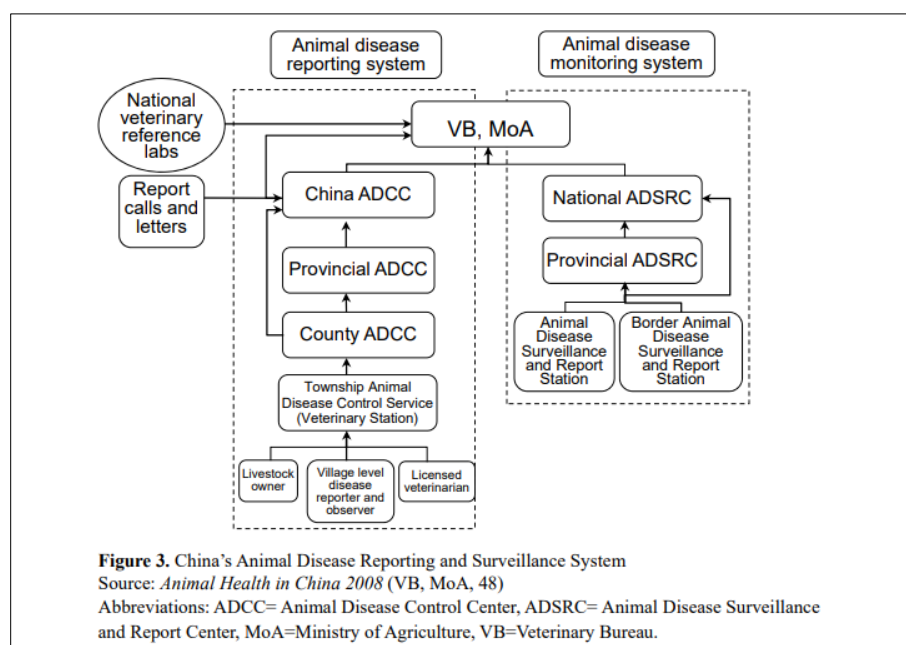

Figure 32. Organizational chart of Public Sector Veterinary Services in China Source: *Animal Health in China 2010*. Source: Wei X, Lin W, Hennessy D A. (2013). *Biosecurity and Disease Management in China's Animal Agriculture Sector*. Center for Agricultural and Rural Development Iowa State University  
<https://www.card.iastate.edu/products/publications/pdf/13wp542.pdf>

As of 2013, the Ministry of Agriculture operated 304 national animal disease surveillance and reporting stations.<sup>609</sup> Surveillance activities are also the responsibility of County and Provincial CADCCs, but available evidence suggests that funding for surveillance activities is limited.<sup>610</sup> Moreover, PRC does not provide sufficient compensation to farmers to incentivize culling of infected animals. Instead,

approximately 90% of funding is dedicated to vaccination campaigns.<sup>611</sup> Like their public health counterparts, animal health authorities also appear to struggle to hire and retain component staff.<sup>612</sup>

### **3. China's Success Identifying and Controlling Infectious Disease Outbreaks Post-SARS**

Despite concerns regarding funding and retention of personnel, China's public health system, including the CCDC and CADCC, have demonstrated the capacity to conduct rapid epidemiological investigations into novel infectious disease outbreaks, including the ability to locate the source of zoonotic spillovers in animal populations.

#### **a. 2013-2017 High Pathogenicity Avian Influenza (HPAI) H7N9**

In March 2013, Hong Kong and PRC public health officials reported the first human cases of influenza A H7N9. Through April and May 2013, the number of human H7N9 cases reported by PRC officials increased to 131. All the infected patients reported handling live poultry. Beginning in April 2013, local PRC public health authorities began to close wet markets that sold live poultry and started large scale culling of susceptible birds. From May 2013 through September 2016 only sporadic cases of H7N9 were reported in China. For example, in 2014 China reported only 102 cases.

The PRC's response to H7N9, including its timely notification of the WHO and transparent sharing of data was widely praised:

China reported the H7N9 outbreak to the World Health Organization (WHO) on 31 March, just six weeks after the first known person fell ill. On the same day, it published the genomic sequences of viruses from the three human cases ... It has also shared all the sequences with the WHO, and live viruses with the WHO and other laboratories. This has allowed scientists to identify the virus's mutations, trace its origins and develop crucial diagnostic tests. China continues to report new cases daily, and its media discusses H7N9 openly. Chinese and other researchers have quickly published detailed analyses of the virus in journals. Chinese President Xi Jinping added political clout last week when he called for an effective response and said that the government must ensure the release of accurate information about the outbreaks.

China's response to the epidemic has also been brisk. Diagnostic tests have been distributed to hospitals and research labs across the country. The response, spearheaded by the Chinese Center for Disease Control and Prevention in Beijing, has united clinicians, virologists, and epidemiologists. Live-bird markets at which H7N9 has been found have been shut down, and birds culled. The agriculture ministry has tested tens of thousands of birds and other animals for the virus, to try to pin down the sources of human infections and explain their occurrence in cities hundreds of kilometres apart — no mean task given that China has some 6 billion domestic fowl and half a billion pigs, which can also carry the virus. So far, however, apart from birds at the live markets, the sources of infection remain elusive.<sup>613</sup>

The total number of H7N9 human cases is not fully known.

Animal disease surveillance for H7N9 is difficult because H7N9 is asymptomatic in poultry. China's policy of mass poultry vaccination may make identifying cases more difficult. However, there is evidence that a far larger number of people have been infected than reported in the official count of laboratory confirmed cases. Blood samples taken from residents of Guangzhou in Guangdong Province estimated that, between January and April 2014, up to 64,000 people were infected with H7N9 compared to the official confirmed case count of 20.<sup>614</sup>

In late-2016, the PRC experienced a surge in new H7N9 cases with 460 human infections reported to the WHO by March 2017. The virus variant responsible for the 2016-2017 cases had mutations that "increased morbidity and mortality in poultry" and that most cases reported were in rural areas where individuals reported exposures to sick or dead poultry.<sup>615</sup> As during the 2013-2014 surge of cases, PRC officials closed markets selling live poultry, increased disease surveillance for susceptible species, and culled exposed and infected animals.<sup>616</sup> After these interventions, reports of human cases began dropping again, suggesting that H7N9, like H5N1, is not easily transmitted to and between humans. However, the virus continues to transmit among susceptible bird populations, including in the United States, and presents an ongoing risk of spilling over into humans.<sup>617</sup>

#### **b. 2016 & 2019 Swine Acute Diarrhoea Syndrome (SADS) Outbreak**

On October 28, 2015, animal infectious disease surveillance systems identified an outbreak of a fatal swine disease in a pig farm in Qingyuan, a city in Guangdong Province, Southern China.<sup>618</sup> The farm in question was located near the cave where SARS is believed to have originated. The farm had also experienced earlier outbreaks of porcine epidemic diarrhoea virus (PEDV, a coronavirus), but after January 2017 deceased piglets no longer tested positive for PEDV, "suggesting an outbreak of a novel disease."<sup>619</sup> Mortality in the youngest piglets, aged 8 days or less, was as high as 90% percent with piglets eight days or older generally surviving infection.

The novel virus was sequenced on January 11, 2017, establishing that the cause of the outbreak was the previously unknown SADS.<sup>620</sup> By May 2, 2017, SADS had killed 24,693 piglets and spread to three additional farms located within 20-150 km of the first farm to experience the outbreak.<sup>621</sup> In an effort to control the outbreak, public health officials began separating sick pigs from the herd. By May 2017, the outbreak appeared to have ended.

From May 2017 until February 2019, animal surveillance did not report any new SADS cases. However, the virus reemerged in Fujian Province, which borders Guangdong Province to the north, in 2018 with an isolated outbreak on a single farm. A second reemergence occurred in Guangdong Province with a large-scale outbreak killing approximately 2,000 piglets on one farm located near the origin of the SADS pandemic in 2017."<sup>622</sup> Neither of these outbreaks led to widespread transmission or required large scale infectious disease control measures.

The investigation was led by Zhengli Shi in collaboration with EcoHealth Alliance. The investigation was funded in part by the National Institute of Allergy and Infectious Diseases (NIAID) of

the National Institutes of Health. The CCP allowed Western researchers to access and compare the piglet SADS-CoV samples with bat specimens collected by Chinese researchers from 2013 to 2016 in Guangdong Province.<sup>623</sup> Researchers were also given access to sera from 35 workers likely exposed to the piglets.<sup>624</sup> The Shi/Daszak investigation into the SADS outbreak is a playbook for how international collaboration can work to identify novel diseases. However, access to similar data was specifically denied following the outbreak of SARS-CoV-2.

### c. 2018-2021 Langya Henipavirus Cases

Between April 2018 and August 2021, infectious disease surveillance at three hospitals in Shangdong and Henan Provinces, in eastern China identified a previously unknown henipavirus<sup>11</sup> in the throat swab samples of three patients with fevers who reported a recent history of animal exposure.<sup>625</sup> The new virus was named Langya henipavirus (LayV). Henipaviruses can cause fatal disease in humans and have been detected in bats, rodents, and shrews.<sup>626</sup> However, LayV's symptoms appear to be relatively mild and there is no evidence of human-to-human transmission as all 35 known cases were independently infected.<sup>627</sup>

“Subsequent investigation identified 35 patients with acute LayV infection in the Shandong and Henan provinces of China, among whom 26 were infected with LayV only.”<sup>628</sup> In an effort to locate the infection source of the human cases, researchers “performed field investigation in the residence village of the infected patients to acquire samples from domestic animals. Serum samples were obtained from 459 domestic animals.”<sup>629</sup> Researchers also trapped and administered PCR tests to 3,380 wild small animals across 25 species.

Animal sampling found that the virus was predominantly detected in shrews with 71 of 262 (27%) those sampled testing positive. The high positivity rate suggests that the shrew may be a natural reservoir for the virus.<sup>630</sup> The research team's findings, including that they discovered a new virus capable of infecting humans, were first published on August 4, 2022 almost four years after the symptom onset of the first case and over a year after the last known human infection.

---

<sup>11</sup> The Henipavirus family includes Nipah and Hendra viruses both of which are capable of causing disease in humans with Nipah virus believed to be capable of human-to-human transmission. Another Henipavirus, Mojiang virus was discovered by WIV researchers in 2012 in the same abandoned Yunnan Province copper mine as bat coronavirus RaTG-13, which is 96.1% and 93.1% similar to SARS-CoV-2 in the total genome and spike protein respectively.

## Chapter 5: Investigations into the Zoonotic Origins of SARS-CoV-2

### Introduction

This section reviews the available evidence on the investigations and data released by the PRC to date on the origins of SARS-CoV-2. There are three sub-sections. The first details the early investigations by PRC public health officials and scientists into the role the Huanan Seafood Market. This sub-section includes evidence of live animal sales at the market, something denied by PRC government officials. It also includes a review of the evidence that the Huanan Market, or its supply chain, were the location of the zoonotic spillover of SARS-CoV-2. The second sub-section details the available information on retrospective investigations by PRC public health officials and scientists that failed to find any evidence of SARS-CoV-2 circulating in humans prior to December 2019, if such an event occurred.

The third sub-section reviews the results of animal surveys conducted by PRC scientists to identify the intermediate host of SARS-CoV-2. These surveys did not find a single animal in China infected with SARS-CoV-2 either before or after the start of the COVID-19 outbreak. This sub-section also reviews studies on SARS-CoV-2 infections and transmission in various animal species, including experimental infections and natural infections caused by human-to-animal transmission of the virus. Finally, this sub-section evaluates the leading candidate intermediate host species based on susceptibility to SARS-CoV-2 and evidence that the species was in the Huanan Market and Wuhan area live market supply chain.

#### 1. Early Investigations into the Huanan Seafood Market

##### a. Association of Early Known COVID-19 Cases with the Huanan Seafood Market

The Huanan Seafood Market, located in the Jianghan District, contains 678 stalls divided across an Eastern and Western zone.<sup>631</sup> The Jianghan District is among the most densely populated areas of Wuhan. The market itself is densely packed with stalls and receives around 10,000 visitors per day.<sup>632</sup> The market is approximately 800 meters (.5 miles) from Wuhan's main train station, which is a central node in China's high speed passenger rail system and, prior to the COVID-19 pandemic, handled 43,000 passengers per day.<sup>633</sup> There are also a number of Wuhan metro stops located near the Huanan Market, 2019 ridership on the Wuhan metro exceeded 1.2 billion.<sup>634</sup> A recent study examining the origins of SARS-CoV-2 have reported identifying over twenty hotels located within 500 meters (1/3 of a mile) of the market.<sup>635</sup>

The association between the Huanan Market and early COVID-19 cases began with the first public report of the outbreak by the Wuhan Municipal Health Commission on December 31, 2019. By the early morning hours of January 1, 2020, Wuhan officials closed and began sanitizing the Huanan Market.<sup>636</sup> A manager whose company was contracted to disinfect the market arrived on December 31, 2019. He observed the CCDC collecting and removing samples from live and dead animals. He reported not seeing any civets, pangolins or bats.<sup>637</sup> The manager was initially unaware that the market was suspected to be the source of a disease outbreak. When he learned of that possibility, he quadrupled the



strength of the bleach solution he used. The solution was so strong it corroded much of his equipment, he said.<sup>638</sup>

According to the WHO, live animals collected from the market were taken away to an unidentified “destination.”<sup>639</sup> Concurrent with the closure of the Huanan market and removal of any live animals, the “Chinese Center for Disease Control and Prevention (CCDC) dispatched an epidemiological team, together with experts from Hubei Provincial CDC and Wuhan Municipal CDC, to collect environmental samples at the Huanan Seafood Market in the early morning of January 1, 2020.”<sup>640</sup> According to the CCDC, its team arrived from Beijing on January 1, 2020 and collected 585 environmental samples from sewers, stalls and a garbage truck. Thirty-three of them tested positive for the virus. There was no mention of any animal samples.<sup>641</sup>

The Huanan Market is the only Wuhan area market that PRC officials have released significant information about. In presentations for the WHO-China Joint Report, PRC researchers stated, “66% of the 41 cases identified before 2 January 2020 were once exposed to the Huanan Market.”<sup>642</sup> Similarly, retrospective case identification by Chinese epidemiologists and public health experts shared with the WHO showed that a preponderance, but not all of early known COVID-19 cases had an association with the Huanan Market.

Out of 174 diagnosed cases of COVID-19 with onset during December 2019, 93 cases had a history of exposure to any markets. Thirty-eight early cases reported having exposure to other Wuhan area markets and 8 cases reported exposure to the Huanan Market **and** other Wuhan markets.<sup>643</sup> Forty-seven cases were only exposed to the Huanan Market. In total, approximately 28% of the earliest known cases had a direct exposure to the Huanan Market. The WHO team was provided the case data from Chinese officials but was not able to independently verify or conduct further analysis of those data.<sup>644</sup> As a result, it is unclear exactly how cases were identified, as the report only states that they were either reported or interviewed.

Among early cases associated with the Huanan Market, “vendors and [wholesale] purchasers accounted for 77% of all cases,” suggesting a significant occupation exposure risk associated with working or prolonged exposure to the market.<sup>645</sup> However, PRC officials informed the WHO-China team that there were no COVID-19 infections in vendors involved in selling domesticated animals.<sup>646</sup> This is a major difference between SARS-CoV-2 and SARS where live animal traders, particularly those handling palm civets, were much more likely to be infected than aquatic seafood, vegetable, and other vendors.<sup>647</sup> By contrast, at the Huanan Market the majority of COVID-19 cases in vendors were among those selling seafood, livestock meat, poultry meat, and vegetables.<sup>648</sup>

#### **b. Environmental Sampling at the Huanan Market**

Chinese public health officials reported collecting 1,996 samples in their investigation of the Huanan Market. Nine hundred twenty-three (923) environmental samples were collected with 1,057 animal-related samples tested.<sup>649</sup> In total, 73 environmental samples tested positive while zero animal-related samples tested positive.

Of the 923 environmental samples, 828 were from inside the Huanan Market.<sup>650</sup> Fifty-one samples were collected from sewers “in the surrounding areas” near the market, resulting in 3 COVID-19 positive samples.<sup>651</sup> Beyond the Huanan Market, 14 environmental samples were collected from “warehouses related” to the Market with five positive samples. No other information is available about which warehouses had positive environmental samples. Thirty environmental samples were also taken from “other markets in Wuhan” with one sample testing positive.<sup>652</sup> The “other markets in Wuhan” were identified as the Dongxihu Market and Huanggang Center Market.<sup>12</sup> However, PRC officials did not identify which of the two markets had the positive sample and no further information on the sampling done, if any, at other Wuhan area markets is available.

With respect to the date of sample collection, PRC state run media reported that 515 of the 825 Huanan Market environmental samples were collected on January 1 with an additional 70 samples collected on January 12.<sup>653</sup> Of the 585 environmental samples collected as of January 12, 2020, 33 tested positive for SARS-CoV-2.<sup>654</sup> Between January 12 and March 2, 2020, public health officials collected an additional 338 environmental samples from “different locations within and around” the Huanan Market which yielded an additional 40 positive samples.<sup>655</sup>

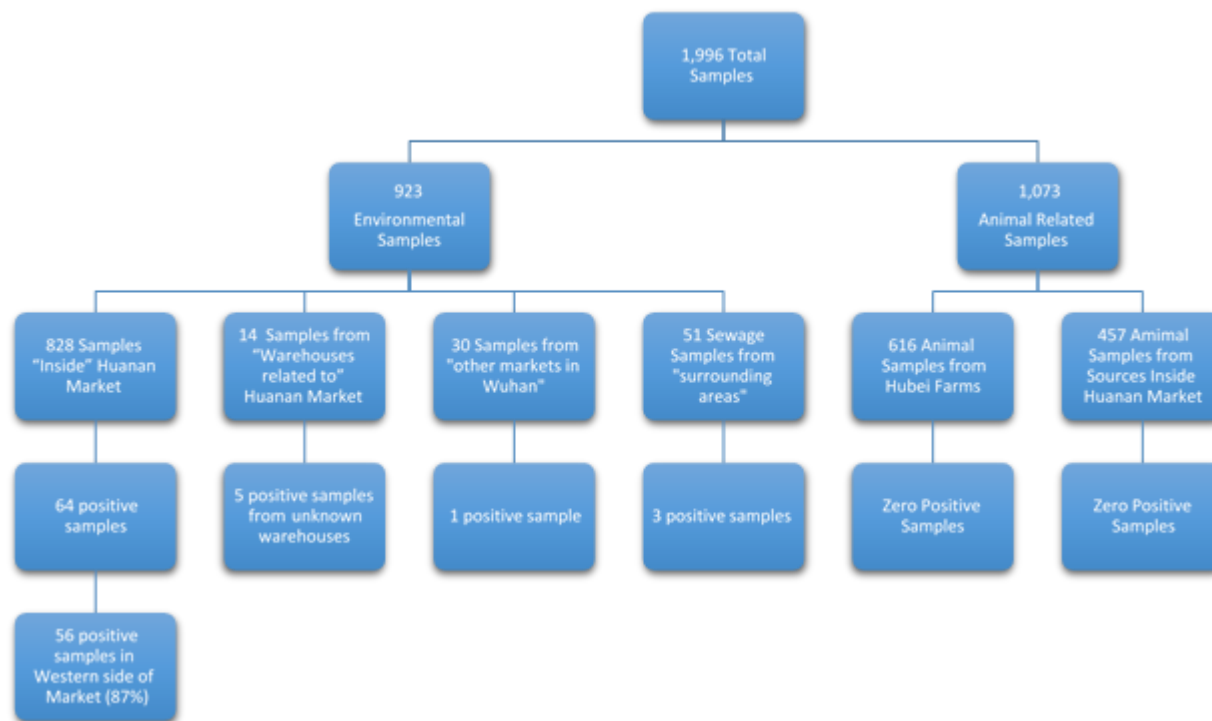

Figure 33. Breakdown of Testing Samples During Investigation into Huanan Seafood Market

Positive environmental samples were associated with the western half of the market, specifically the south-west section. A leaked CCDC Report dated January 22, 2020 shows 44 positive samples collected on January 1 and 12, 2020 were linked to 21 specific vendors, 19 of which were located in the

<sup>12</sup> Based on a Google Earth search it appears the Dongxihu Market is located approximately 6.5 miles west of the Huanan Seafood Market. Huanggang Center Market is harder to locate and may not be in Wuhan. Huanggang is a city in Hubei Province and has a Huangzhou Center Market that is approximately 38 miles away from the Huanan Seafood Market.

western side of the Huanan market.<sup>656</sup> How public health officials selected specific stalls for testing has



not been disclosed, but environmental sampling of the market covered 134 of 678 vendors (19.8%).<sup>657</sup> In all, 56 of 73 positive environmental samples from inside the Huanan Market were located in the western zone of the market, representing

87.5% of positive samples.<sup>658</sup> Of these 56 positive environmental samples from inside the market, 40 samples (71.4%) were located between rows 1 through 8 in the south-western section of the market.<sup>659</sup>

Figure 34. Map of the Huanan Market, showing locations of stalls where domesticated wildlife products were sold in relation to environmental testing results, and confirmed human cases of COVID-19. Source: <https://www.who.int/publications/i/item/who-convened-global-study-of-origins-of-sars-cov-2-china-part>

Figure 34: Map of Huanan Seafood Market showing locations of stalls where domesticated wildlife products were sold in relation to environmental testing results and confirmed human cases of COVID-19. Red boxes show association between southwest section of market and COVID-19 cases and positive environmental samples. Adapted from WHO-China Joint Report. Source: Gao G, Liu W, Liu ZP, et al. (2022) Surveillance of SARS-CoV-2 in the environment and animal samples of the Huanan Seafood Market. PREPRINT (Version 1) available at Research Square <https://doi.org/10.21203/rs.3.rs-1370392/v1>

### c. Animal Sampling at the Huanan Seafood Market

In addition to taking environmental samples, 457 animal-related samples from “188 individuals of 18 species” were collected between January 1 and March 30, 2020.<sup>660</sup> According to presentations by PRC public health officials to the WHO, none of the samples tested positive for SARS-CoV-2.<sup>661</sup> PRC officials informed that none of the “animal-related” samples were taken from live animals present at the market:

The sources of the samples include unsold goods kept in refrigerators and freezers in the stalls of [Huanan Market], and goods kept in warehouses and refrigerators related to the [Huanan Market]. Samples from stray animals in the market were also collected, i.e., swab samples from 10 stray cats, 27 cat feces, one dog, one weasel, and 10 rats.... All the 457 animal samples tested negative for SARS-CoV-2 nucleic acid, suggesting that the animal infections with SARS-CoV-2 might be rare in the market.<sup>662</sup>

Nucleic Acid Testing (NAT)	
Hubei	
Number of species	10
Specific types of animals	Bamboo Rat, Porcupine, Duck, Snake, Rabbit/Hare, Chicken, Ostrich/Turkey, Wild Boar
Total sample size	616
Test results	Negative

PRC officials denied any illegal live animal sales occurred at the Huanan Market.<sup>663</sup> Presentations to the WHO, PRC officials identified “10 animal selling stalls in the Huanan Market, accounting for 1.5% of the total” stalls.”<sup>664</sup> Reviewing sales records provided by PRC officials, the WHO-China Report concluded that those 10 stalls sold “animals or products”, but that the only live animals sold were snakes, salamanders, and crocodiles.<sup>665</sup> None of which are susceptible to SARS-CoV-2, and thus are unlikely to be intermediate hosts.<sup>666</sup> All other animals were reportedly sold as frozen goods, including bamboo rats, badgers, hedgehogs, sika deer, and porcupines.<sup>667</sup>

PRC officials also reported to the WHO-China Joint Report Team that, “extensive collection and

Table 5. Survey of animals from Huanan market suppliers in Hubei. Source: WHO-convened Global Study of Origins of SARS-CoV-2: China Part Joint WHO-China Study 14 January-10 February 2021 Joint Report <https://www.who.int/docs/default-source/coronaviruse/who-convened-global-study-of-origins-of-sars-cov-2-china-part-joint-report.pdf>

testing ... animals in upstream supply farms took place,” but that “the SARS-CoV-2 PCR test results were all negative.” In all, 616 “samples from animals raised by some Huanan market suppliers in Hubei were...sampled and tested between February and March 2020.”<sup>668</sup> All 616 samples from Huanan Market suppliers in Hubei Province were reported as testing negative.<sup>669</sup> The WHO-China Report notes that the Huanan Market sold “farmed wildlife” from Heilongjiang, Jilin, Shanxi, Henan, Hunan, Jiangxi, Guangdong, Guangxi, and Yunnan provinces. The PRC has provided no information whether animals from wildlife farms in these provinces that supplied Huanan Market were tested for SARS-CoV-2.<sup>670</sup>

#### d. Evidence of Live Animal Sales at the Huanan Seafood Market in November-December 2019

The WHO-China Report noted that there were “unverified media reports in 2020” of live animal sales at the Huanan Seafood Market,<sup>671</sup> but ultimately concluded that, “no verified reports of live mammals being sold around 2019 were found”<sup>672</sup> with the Report’s Annex stating the joint-team’s visit to the market found “no evidence of the sale of live mammals”.<sup>673</sup> Despite their conclusions, the joint WHO-China team observed that during their site visit to the market, “[t]here was a mixed smell of animals and disinfection in some areas of the market, even a year since its closure.”<sup>674</sup>

On June 7, 2021, a group of researchers published an article in *Nature’s Scientific Reports* detailing live animal sales in wet markets across Wuhan, including from seven shops at the Huanan Seafood Market.<sup>675</sup> The survey sought to identify the course of Severe Fever with Thrombocytopenia Syndrome (SFTS) found in animals in Hubei Province following a 2009-2010 outbreak.<sup>676</sup> The survey period ran from May 2017 to **November 2019** with the lead author, Xiao Xiao, conducting regular visits to 17 wet market shops across multiple markets that sold live wild animals.<sup>677</sup>

This survey directly contradicts the information the PRC provided to the WHO and represents the most complete picture of nature and scope of live wild animals’ sales in Wuhan area wet markets in the months leading up to the outbreak. During the study, Xaio observed:

All animals were sold alive, caged, stacked and in poor condition. Most stores offered butchering services, done on site, with considerable implications for food hygiene and animal welfare. Approximately 30% of individuals from 6 mammal species inspected had suffered wounds from gunshots or traps, implying illegal wild harvesting. Thirteen of these 17 stores clearly posted the necessary permits from Wuhan Forestry Bureau allowing them to sell legitimate wild animal species ... for food; four shops had no such permit. Species names were given in Chinese only, with no clear taxonomic binomial designation. None of the 17 shops posted an origin certificate or quarantine certificate, so all wildlife trade was fundamentally illegal.<sup>13</sup>

In total, Xiao recorded that these 17 shops (out of a total approximately 660 total shops in all markets) sold 36,295 animals across 38 species from May 2017 to November 2019, with an average of 1,170.81 live wild animals sold per month across all markets. The article found that at least “four species with known susceptibility to SARS-related coronaviruses were found among the species sold at the markets: raccoon dogs, hog badgers, masked palm civets, and mink” and that all four species were sourced primarily from farms as opposed to captured wildlife.

---

<sup>13</sup> Internal references omitted.

Table 6. List of 38 species sold in Wuhan City markets between May 2017–Nov 2019, including the mean number of live individuals sold per month and price (mean±SD; n=survey rounds). Individuals sourced directly from the wild were inferred from wounds (W) and/or according to vendor responses (R). Species were sold either for food (F) and/or pets (P)

Species on sale	Monthly mean (and SD) number of individuals sold	Price (mean ± SD) \$ per individual
<b>Mammals</b>		
Raccoon dog ( <i>Nyctereutes procyonoides</i> ) <sup>WR,F†</sup>	38.33 ± 17.24 (n = 30)	63.32 ± 15.46 (n = 5)
Amur hedgehog ( <i>Erinaceus amurensis</i> ) <sup>R,F†</sup>	332.14 ± 190.62 (n = 28)	2.66 ± 0.41 (n = 5)
Siberian weasel ( <i>Mustela sibirica</i> ) <sup>WR,F†</sup>	(10.06 ± 12.09, n = 31)	11.24 ± 3.07 (n = 5)
Hog badger ( <i>Arctonyx albogularis</i> ) <sup>WR,F†</sup>	(6.81 ± 5.37, n = 31)	72.79 ± 34.08 (n = 5)
Asian badger ( <i>Meles leucurus</i> ) <sup>WR,F†</sup>	12.24 ± 7.39 (n = 29)	59.77 ± 15.89 (n = 5)
Chinese hare ( <i>Lepus sinensis</i> ) <sup>WR,F†</sup>	168.96 ± 89.06 (n = 29)	16.87 ± 2.88 (n = 5)
Pallas's squirrel ( <i>Callosciurus erythraeus</i> ) <sup>R,R†</sup>	16.52 ± 4.87 (n = 23)	25.74 ± 7.59 (n = 5)
Masked palm civet ( <i>Paguma larvata</i> ) <sup>E†</sup>	10.69 ± 8.42 (n = 29)	62.73 ± 15.25 (n = 5)
Chinese bamboo rat ( <i>Rhizomys sinensis</i> ) <sup>F†</sup>	42.76 ± 20.68 (n = 29)	18.64 ± 7.58 (n = 5)
Malayan porcupine ( <i>Hystrix brachyura</i> ) <sup>F†</sup>	10.00 ± 0.00 (n = 29)	68.06 ± 14.23 (n = 5)
Chinese muntjac ( <i>Muntiacus reevesi</i> ) <sup>E†</sup>	10.00 ± 0.00 (n = 29)	142.62 ± 49.67 (n = 5)
Coypu ( <i>Myocastor coypus</i> ) <sup>F</sup>	5.00 ± 0.00 (n = 29)	28.70 ± 5.08 (n = 5)
Marmot ( <i>Marmota himalayana</i> ) <sup>F</sup>	15.00 ± 4.29 (n = 20)	81.37 ± 11.70 (n = 5)
Red fox ( <i>Vulpes vulpes</i> ) <sup>E†</sup>	30.00 ± 0.00 (n = 25)	60.96 ± 21.68 (n = 5)
Mink ( <i>Neovison vison</i> ) <sup>F</sup>	10.37 ± 1.92 (n = 27)	34.62 ± 14.78 (n = 5)
Red squirrel ( <i>Sciurus vulgaris</i> ) <sup>R,R†</sup>	16.43 ± 9.51 (n = 28)	26.04 ± 8.14 (n = 5)
Wild boar ( <i>Sus scrofa</i> ) <sup>WR,F,*†</sup>	(4.17 ± 5.77, n = 29)	319.57 ± 55.95 (n = 5)
Complex-toothed Flying Squirrel ( <i>Trogopterus xanthipes</i> ) <sup>F,R†</sup>	5.17 ± 27.85 (n = 29)	28.11 ± 9.64 (n = 5)

Source: Xiao, X., Newman, C., Buesching, C.D. et al. (2021) Animal sales from Wuhan wet markets immediately prior to the COVID-19 pandemic. *Sci Rep* **11**, 11898. <https://www.nature.com/articles/s41598-021-91470-2>

On December 3, 2019, an unidentified “concerned citizen” took photographs showing live animals being traded in the Huanan Seafood Market, including animals known to be susceptible to SARS-CoV-2, such as minks, weasels, raccoon dogs, Malayan porcupines, Chinese muntjacs, marmots and red foxes. According to a CNN reporter, the individual posted the photographs to the Chinese Social Media platform Weibo as he or she was “concerned about the conditions under which live animals were being traded at the market, and they have been reported on previously.”



Figure 35. Poor welfare of animals on sale in Huanan seafood market: (a) King rat snake (*Elaphe carinata*), (b) Chinese bamboo rat (*Rhizomys sinensis*), (c) Amur hedgehog (*Erinaceus amurensis*) (the finger points to a tick), (d) Raccoon dog (*Nyctereutes procyonoides*), (e) Marmot (*Marmota himalayana*) (beneath the marmots is a cage containing hedgehogs), and (f) Hog badger (*Arctonyx albogularis*).

Source: Xiao, X., Newman, C., Buesching, C.D. et al. (2021) Animal sales from Wuhan wet markets immediately prior to the COVID-19 pandemic. *Sci Rep* **11**, 11898. <https://www.nature.com/articles/s41598-021-91470-2>

The individual told the CNN reporter the photographs were taken on December 3, 2019, and posted on January 3, 2020 “within just a few days of the first public announcement of unexplained pneumonia cases linked to the Huanan market. By January 4 or 5, 2020 the photos had been removed from Weibo.”<sup>678</sup> Copies of the photographs received by CNN were compressed images with no metadata, further complicating efforts to verify their authenticity.<sup>14</sup>

<sup>14</sup> “The source stated that he had lost his phone with the original image files but had retrieved files from a friend’s WeChat chatting history; the chat happened between this source and his friend on the day that these photographs were taken, the source said. The CNN journalist stated that WeChat would indeed compress the images and strip them of metadata, consistent with the files provided by the source to the CNN journalist”.



Figure 36. Photographs from inside the Huanan market. A-C: photographs taken by a concerned citizen on 3 December 2019, posted on Weibo and reported by CNN (37). Source: Worobey, M., Levy, J. I., Malpica Serrano, L., Crits-Christoph, A., Pekar, J. E., Goldstein, S. A., Rasmussen, A. L., Kraemer, M. U. G., Newman, C., Koopmans, M. P. G., Suchard, M. A., Wertheim, J. O., Lemey, P., Robertson, D. L., Garry, R. F., Holmes, E. C., Rambaut, A., & Andersen, K. G. (2022). The Huanan Seafood Wholesale Market in Wuhan was the early epicenter of the COVID-19 pandemic. *Science* (New York, N.Y.), 377(6609), 951–959. <https://doi.org/10.1126/science.abp8715>

If genuine, these photographs corroborate Xiao’s Wuhan market surveys and are evidence that live animal trading of species known to be susceptible to SARS-CoV-2 was occurring at the Huanan Market during early-December 2019. The flooring, drains, and concrete walls shown in the January 2020 photographs are consistent with photographs taken in the western section of the Huanan market in October 2014 by virologist Eddie Holmes during a visit to Wuhan.



Figure 37. Photographs from inside the Huanan market. D, E: photographs taken in the western section of the Huanan market on 29 October 2014. Note that the raccoon dogs appear to be local, wild-caught common raccoon dogs rather than farmed raccoon dogs and that their plush coats are consistent with those observed in the winter. Source: Worobey, M., Levy, J. I., Malpica Serrano, L., Crits-Christoph, A., Pekar, J. E., Goldstein, S. A., Rasmussen, A. L., Kraemer, M. U. G., Newman, C., Koopmans, M. P. G., Suchard, M. A., Wertheim, J. O., Lemey, P., Robertson, D. L., Garry, R. F., Holmes, E. C., Rambaut, A., & Andersen, K. G. (2022). The Huanan Seafood Wholesale Market in Wuhan was the early epicenter of the COVID-19 pandemic. *Science* (New York, N.Y.), 377(6609), 951–959. <https://doi.org/10.1126/science.abp8715>



These 2014 photographs provide corroboration that the purported December 3, 2019, photographs were taken at the Huanan Seafood Market. Taken together with the Wuhan market animal survey they are evidence that, contrary to the assertions of PRC officials, sales of live animals were occurring on a regular basis in Wuhan area wet markets from October 2014 to December 2019.

“According to sales records, during late December 2019, animals or animal products were sold in these 10 animal stalls and animals included snakes, avian species (chickens, ducks, geese, pheasants and doves), Sika deer, badgers, rabbits, bamboo rats, porcupines, hedgehogs, salamanders, giant salamanders, bay crocodiles and Siamese crocodiles, etc., among which snakes, salamanders and crocodiles were traded as live animals.”<sup>679</sup> Another study documented the animal species in Huanan market noted that no pangolins or bats were traded there.<sup>680</sup>

### 3. The Role of Huanan Seafood Market in the SARS-CoV-2 Outbreak

The Huanan Seafood Market seemingly played a critical role in the early outbreak, but its exact role is unclear. The association between the earliest known COVID-19 cases and the Huanan Seafood Market is one of the strongest pieces of evidence suggesting a natural zoonotic spillover origin to COVID-19. Live animal sales at markets are a known zoonotic risk and this association in some ways parallels the spillover events that led to the 2002-2003 SARS epidemic.<sup>681</sup>

Despite denials by PRC authorities, several animal species known to be susceptible to SARS-CoV-2 appear to have been present in the Huanan Market in the months prior to the COVID-19 pandemic. Whether the COVID-19 cases and positive environmental samples found at the Huanan Market represent the “epicenter” of the SARS-CoV-2 spillover from animals to humans<sup>682</sup> or an early super spreading event remains an area of active scientific discussion.<sup>683</sup>

#### a. Early Variants and Evidence the Huanan Market was an Early Super Spreading Event

The crux of the debate centers on a “paradox” in the Huanan Seafood Market data. The early genomic sequences of SARS-CoV-2 fall into two different groups, called lineages “A” and “B”.<sup>684</sup> The two lineages only differ by two mutations. Since SARS-CoV-2 evolves rapidly, it is common for different viral sequences to differ by two mutations. Studies of viral transmission suggests that SARS-CoV-2 sometimes acquires two mutations in a single transmission event.<sup>685</sup> Lineage A is more similar to the bat coronaviruses from which SARS-CoV-2 is believed to ultimately be derived. This fact suggests that either Lineage A evolutionarily preceded Lineage B, or that if Lineage B was the predecessor there must have been a statistically unlikely evolutionary path that led to acquisition of two mutations back towards the bat coronavirus predecessor.

For this reason, until recently, most studies interpreted the sequence data as indicating that SARS-CoV-2 arose from a single introduction into humans of a lineage A virus from some unknown source with all subsequent evolution, including the divergence of lineage B from lineage A, occurring in humans. For example, based on analysis of early SARS-CoV-2 sequence, one expert on viral evolution concluded:

*“One of the biggest takeaway messages is that there was a single introduction into humans and then human-to-human spread.”*<sup>686</sup>

The “paradox” is that many of the first known human COVID-19 cases are associated with the Huanan Seafood Market and the genomic sequences of these cases fall within lineage B.<sup>687</sup> In addition, all but one environmental sample collected at the Huanan market also fall within lineage B.<sup>688</sup> Thus, lineage B predominated among the earliest known COVID-19 cases as well as in environmental samples from Huanan Market, but lineage A appears to be the first introduction of the virus into humans.<sup>689</sup>

The majority view of scientists is that the presence of lineage B viruses at the Huanan Seafood Market indicates that these COVID-19 cases and environmental samples from late December 2019 and early 2020 are evidence of an early super spreading event rather than evidence that the zoonotic spillover of SARS-CoV-2 occurred physically (or “for the first time”) at the market. Proponents of the Huanan Seafood Market as super spreading event also note that available data on lineage A is likely incomplete given that some early samples from Wuhan have not been fully sequenced and others have been deleted.<sup>690</sup> In addition, as described above, early criteria for identification of COVID-19 cases emphasized a link to the market, which could have led to preferential identification of lineage B cases associated with the market

The theory that the COVID-19 pandemic began with a single introduction of a lineage A SARS-CoV-2 virus, with lineage B then diverging several weeks later in humans, has been proposed by a substantial number of peer-reviewed studies, but is not the sole, consensus view. Other studies have remained troubled by the inconsistency that sequence analyses suggest the most ancestral sequences are lineage A but the first reported sequences are lineage B and have cautioned “against strong inferences regarding the early spread of the virus based solely on such evidence.”<sup>691</sup>

A recent study by Pekar et. al. (Pekar study) has suggested a different theory. The Pekar study, which is a companion paper to the Worobey study mentioned earlier in this section, posits that SARS-CoV-2 jumped twice into humans from one or more unidentified animal source at the Huanan Seafood Market.<sup>692</sup> Under this theory, the divergence between lineage A and B occurred in animals prior to two separate introductions to humans at the Huanan market. This theory is inconsistent with two recent studies. One study, still in pre-print, by the Chinese CDC reported that SARS-CoV-2 was not found in any animals sampled at the Huanan Seafood Market, and that the market “might have acted as an amplifier” event rather than the origin.<sup>693</sup>

The Chinese CDC study, led by CCDC Director Dr. George Fu Gao, also reported that the only lineage A sample from the market, was found on a glove not sampled until January 1, 2020, so it is unclear if this glove represents an outside human sample introduced to the market.<sup>694</sup> The second study, which has passed peer-review, suggests that transmission at the Huanan market may have occurred from human-to-human in toilets and Mahjong rooms rather than from animals; supporting the role of the market as an amplifier event rather than a site of animal-to-human transmission.<sup>695</sup>

#### **b. Evidence Huanan Seafood Market and Related Supply Chain were the “Epicenter” of the COVID-19 Outbreak**

The theory presented in the Pekar study presupposes that the earliest known COVID-19 cases from late-December 2019 represent some of the very first human COVID-19 cases. As a result, because the earliest known COVID-19 cases fall within lineage B, lineage B likely “began spreading earlier in humans” than lineage A.<sup>696</sup> Since lineage B cases and environmental samples predominate at the Huanan Seafood Market, it would therefore then be likely that the market, or its supply chain, was the location for the zoonotic spillover of SARS-CoV-2 into humans.<sup>697</sup> In reaching this conclusion, the Pekar Study draws heavily from a companion study by Worobey et. al. (“Worobey study”) published concurrently.

The Worobey study is an important paper with respect to the origins of SARS-CoV-2 and the role of the Huanan Seafood Market. As a pre-print it received substantial media coverage, in large part because study stated that its “analyses provide dispositive evidence off for the emergence of SARS-CoV-2 via the live wildlife trade and identify the Huanan market as the unambiguous epicenter of the COVID-19 pandemic.”<sup>698</sup> While the peer reviewed version backs away from the dispositive evidence claim, it represents the most forceful and complete argument in favor of the theory that Huanan Seafood Market was the “epicenter” of the COVID-19 outbreak and not just an early super spreading event. As such, it is worth reviewing at length.<sup>699</sup> The study argues:

The earliest known COVID-19 cases from December 2019, including those without reported direct links, were geographically centered on this [Huanan] market. We report that live SARS-CoV-2 susceptible mammals were sold at the market in late 2019 and, within the market, SARS-CoV-2-positive environmental samples were spatially associated with vendors selling live mammals. While there is insufficient evidence to define upstream events, and exact circumstances remain obscure, our analyses indicate that the emergence of SARS-CoV-2 occurred via the live wildlife trade in China and show that the Huanan market was the epicenter of the COVID-19 pandemic.<sup>700</sup>

Citing to the Xiao study’s animal survey<sup>701</sup>, the study observes that “the Huanan market was among four markets in Wuhan reported to consistently sell a variety of live, wild-captured or farmed, mammal species in the years and months leading up to the COVID-19 pandemic.”<sup>702</sup> Several species of live animals found at the Huanan Market in the Xiao study are known to be susceptible to SARS-CoV-2.<sup>703</sup>

The Worobey study found records of fines issued to Huanan Market vendors for illegal wildlife sales.<sup>704</sup> On May 7, 2019, Wuhan authorities issued citations to two Huanan Market vendors whose stalls illegally sold hedgehogs.<sup>705</sup> The stalls fined for selling hedgehogs were located in the south west corner of the market on rows 6 and 8.<sup>706</sup> In addition to the fines, Huanan market stalls’ business registry entries also identified a number of previously unidentified stalls that appear to sell “live or freshly butchered mammals, or other unspecified meat products in the western section of the market.”<sup>707</sup>

This finding builds on evidence presented in the WHO-China Joint Report and the leaked January 22 CCDC report showing that 90% of the positive environmental samples collected on January 1 and 12, 2020 were linked to vendors on the western side of the Huanan market. That 87.5% of all positive environmental samples were taken from the western half of the market. **In total, 71.4% of all positive environmental samples located between rows 1 through 8 in the south-western section of the market.**<sup>708</sup>

The Worobey study also identified five additional stalls, not previously identified in the WHO-China Report that were likely engaged in live animal sales and butchering, bringing the total number of Huanan Seafood Market stalls that sold animals to 15 out of 678 stalls. Of the stalls in the southwestern section of the Huanan Market, the study identifies Stall 29 in row six as particularly notable. Stall 29 has “game” in its title and “lists game retail as a service in the business directory”.<sup>709</sup> Its owner was one of two vendors fined for illegal hedgehog sales in Mary 7, 2019.<sup>710</sup> While there was no record of a human COVID-19 case associated with the stall, the stall itself had five positive environmental samples.<sup>711</sup> However, it is important to note that, the heaviest sampling was around stalls selling animals. **So, while there are numerically more positive samples associated with stalls selling animal products, the percent of positive samples is not any higher for animal product associated samples.**<sup>712</sup>

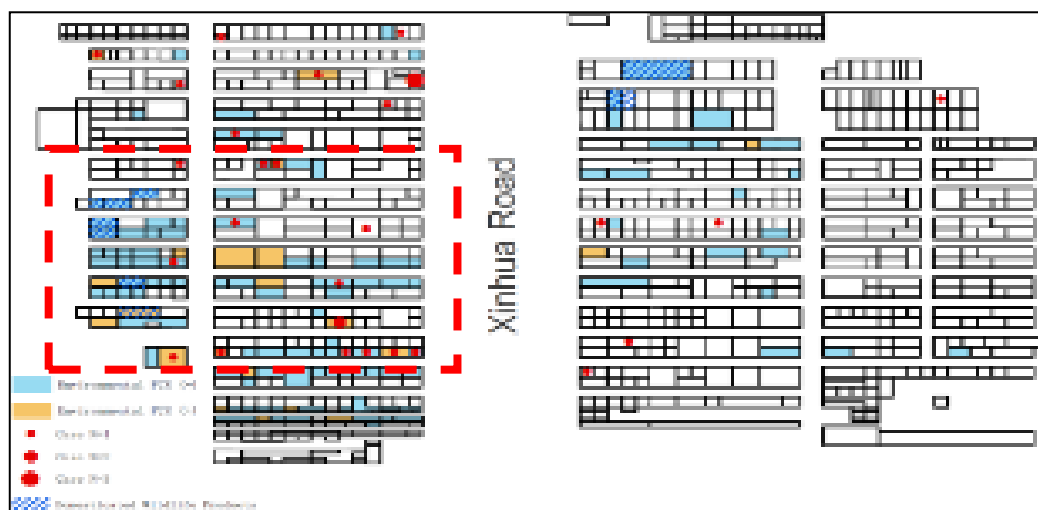

Figure 38. Map of the Huanan Market, showing locations of stalls where domesticated wildlife products were sold in relation to environmental testing results, and confirmed human cases of COVID-19. Source: <https://www.who.int/publications/i/item/who-convened-global-study-of-origins-of-sars-cov-2-china-part>

Moreover, “the objects sampled [at Stall 29] showed an association with animal sales, including a metal cage, two carts (of the kind frequently used to transport mobile animal cages) and a hair/feather remover.”<sup>713</sup> A sewage grate located at or near Stall 29 also recorded a positive environmental sample. [Note: All the four sewerage wells in the market tested positive]<sup>714</sup> In an incredible coincidence, Stall 29 was visited and photographed by a co-author of the Worobey study, Dr. Edward Holmes, in 2014. During his visit Dr. Holmes, “observed live raccoon dogs housed in a metal cage stacked on top of a cage with live birds” in 2014.<sup>715</sup>



Figure 40. Photographs from inside the Huanan market. D, E: photographs taken in the western section of the Huanan market on 29 October 2014. Source: Worobey, M., Levy, J. I., Malpica Serrano, L., Crits-Christoph, A., Pekar, J. E., Goldstein, S. A., Rasmussen, A. L., Kraemer, M. U. G., Newman, C., Koopmans, M. P. G., Suchard, M. A., Wertheim, J. O., Lemey, P., Robertson, D. L., Garry, R. F., Holmes, E. C., Rambaut, A., & Andersen, K. G. (2022). The Huanan Seafood Wholesale Market in Wuhan was the early epicenter of the COVID-19 pandemic. *Science (New York, N.Y.)*, 377(6609), 951–959. <https://doi.org/10.1126/science.abp8715>

Additional analysis in the study of popular social media check in locations for Wuhan, suggests that the Huanan Seafood Market is not disproportionately crowded or popular than other markets and areas of Wuhan.<sup>716</sup> The study argues that this data shows there are other places in Wuhan that would be as likely or more than the Huanan Seafood Market to have COVID-19 super spreading events. Therefore, the study posits that the Huanan Seafood Market COVID-19 cases in late-December 2019 are more likely to represent zoonotic spillover than human-to-human transmission in a super spreading event because despite other locations being more favorable to super spreading events “no other regions in Wuhan showed a comparable [COVID-19] case density” to the Huanan Seafood Market in the earliest days of the COVID-19 outbreak.<sup>717</sup>

The study also attempted to determine the location of 165 of 174 retrospectively identified COVID-19 cases<sup>15</sup> with symptom onset dates in December 2019 through spatial analysis.<sup>718</sup> This spatial analysis exercise was necessary to determine the approximate location of the earliest cases because PRC officials have not released location information for these cases beyond the two low resolution maps provided to the WHO-China Joint team. The study overlaid the two low-resolution maps of Wuhan that displayed the approximate location of the 165 retrospective cases with a map of Wuhan created by OpenStreetMap, an open source “wiki” style mapping website.

By collating these different maps, the study provides an approximate location for most of the cases with a December 2019 onset within a roughly 250-foot radius. Latitude and longitude coordinates were taken from the center of each radius. The resulting location of these cases cluster near the Huanan

<sup>15</sup> These retrospectively identified cases were reported in the WHO-China Joint Report. According to the Report, PRC public health authorities retrospectively searching for possible cases in China’s NNDRS surveillance system “only considered cases sufficiently likely to warrant isolation (whether in hospital or elsewhere) were included” as possible COVID-19 cases.

Market.<sup>719</sup> This spatial analysis has been criticized by statisticians as “not convincing” and that “[t]he analysis in the paper does not give a proof of the centrality of the Market in the 155 December cases. On the contrary, our analysis suggests that the Market is in fact unlikely to be the spatial “center” of the cases.”<sup>720</sup>

Despite these criticisms, the Worobey study is one of the most detailed analyses of the available information regarding the COVID-19 cases and environmental samples from the Huanan Seafood Market. Nevertheless, the study’s authors have candidly acknowledged its limitations due to gaps in available evidence:

We have been able to recover location data for most of the December-onset COVID-19 cases identified by the WHO mission and have been able to do so with sufficient precision to support our conclusions. However, we do not have access to the precise latitude and longitude coordinates of all these cases. Should such data exist, they may be accompanied by additional metadata, some of which we have reconstructed, but some of which, including the date of onset of each case, would be valuable for ongoing studies. We also lack direct evidence of an intermediate animal infected with a SARS-CoV-2 progenitor virus either at the Huanan market or at a location connected to its supply chain, like a farm. Additionally, no line list of early COVID-19 cases is available and we do not have complete details of environmental sampling, though compared to many other outbreaks, we have more comprehensive information on early cases, hospitalizations and environmental sampling.<sup>721</sup>

The authors of the Pekar study acknowledge similar limitations due to missing evidence from the earliest days of the COVID-19 outbreak:

Importantly, we lack direct evidence of a virus closely related to SARS-CoV-2 in non-human mammals at the Huanan market or its supply chain. The genome sequence of a virus directly ancestral to SARS-CoV-2 would provide more precision regarding the timing of the introductions of SARS-CoV-2 into humans and the epidemiological dynamics prior to its discovery. Although we simulated epidemics across a range of plausible epidemiological dynamics, our models represent a timeframe prior to the ascertainment of COVID-19 cases and sequencing of SARS-CoV-2 genomes and thus prior to when these models could be empirically validated.<sup>722</sup>

At the root of the continued uncertainty over the role of the Huanan Market in the COVID-19 pandemic is the apparent failure of PRC officials to test animals removed from the market after the association between the market and the earliest known COVID-19 cases was discovered.<sup>723</sup> Moreover, both the Worobey and Pekar studies rely on data presented to the WHO by PRC authorities, neither study had access to the underlying data. By contrast the authors of the CCDC<sup>16</sup> pre-print, who presumably did

---

<sup>16</sup> Despite being publicly released around the same time as the Worobey and Pekar studies, the CCDC study has not cleared peer-review. Individuals with knowledge of the peer review status of the CCDC study have told this investigation that the CCDC study has been rejected because its authors have not been able to provide the raw data related to the Huanan Seafood Market on which their findings are based. If accurate, the rejection seems inconsistent

have access to the underlying raw data, reached the opposite conclusion from Worobey and Pekar, concluding that the Huanan Market was a super spreading event and not the location of SARS-CoV-2's spillover into humans.<sup>724</sup>

The failure to test animals with links to the Huanan Seafood Market is inconsistent with China's experience from investigating the origins of the SARS epidemic where testing of animals in Guangdong province wet markets identified palm civets as the likely intermediate host of the virus. It is also inconsistent with PRC public health officials' actions during more recent outbreaks' investigations into zoonotic spillovers of High Pathology Avian Influenzas H5N1 and H7N9 and multiple outbreaks of Swine Acute Diarrhea Syndrome Coronavirus (SADS-CoV) at pig farms.<sup>725,726,727</sup> In all of these prior disease outbreaks public health officials tested animals, including after culling, found in live markets or farms associated with the outbreak of an infectious disease.<sup>728</sup>

### c. Sequencing of Huanan Seafood Market Environmental and Animal Samples

A preprint study conducted by the former Director of China's CDC George Fu Gao, analyzed 1,380 environmental samples collected from environment and animals within the Huanan Seafood Market in early 2020. His study identified 73 SARS-CoV-2 positive environmental samples. Three live viruses were successfully isolated from these environmental samples. None of the animal swabs taken from the 18 animal species found in the market were positive for SARS-CoV-2.

The three live viruses from environmental isolates were sequenced. These viruses shared 99.980% to 99.993% similarity with human isolates recovered from Wuhan (HCoV/Wuhan/IVDC-HB-01). As the author described, the findings "provided convincing evidence" of the prevalence of human derived SARS-CoV-2 in the Huanan Seafood Market during the early course of the Wuhan outbreak.<sup>729</sup>

## 4. Retrospective Searches for Evidence of Earliest Human Cases of SARS-CoV-2

Presentations by PRC scientists on their efforts to retrospectively identify when SARS-CoV-2 began circulating in Wuhan to the WHO-China Joint Team found no evidence of COVID-19 cases prior to December 2019. Influenza-like illness (ILI) and severe acute respiratory infection (SARI) surveillance results shared by Chinese officials reported "no evidence to suggest substantial SARS-CoV-2 transmission in the months preceding the outbreak in December." All-cause mortality data, presented to the WHO-China Joint Team showed "average mortality in the months of October to December in 2019 . . . until a steep increase beginning" the week of January 15, 2020.

In addition to reviewing ILI and SARI surveillance data, PRC scientists also conducted retrospective testing of stored respiratory tract samples collected during standard ILI surveillance.<sup>730</sup> The presentations given to the WHO-China Joint Team reported that all of the 658 samples collected in

---

with peer review process afforded the Worobey and Pekar studies. All three studies rely on the same information, namely the results of the PRC public health authorities' investigation into the Huanan Market as presented to WHO-China Joint Team. The CCDC was one of the leading agencies conducting that investigation and the authors of the CCDC study very likely participated in the investigation. It is unclear why the same undisclosed data is sufficiently reliable for the Worobey and Pekar studies to pass peer review while not being sufficiently reliable for the CCDC study to be accepted.

Wuhan in “late 2019” were negative for SARS-CoV-2 infection.<sup>731</sup> All 6,460 samples collected in Hubei Province from outside Wuhan were also negative.<sup>732</sup> However, 9 of 120 samples collected for ILI surveillance in January 2020 tested positive for SARS-CoV-2.<sup>733</sup>

SARI surveillance samples collected in Wuhan (28) and Hubei (246) “late 2019” were also all negative.<sup>734</sup> Data presented to the WHO on mortality surveillance in Wuhan during 2019 and 2020, including pneumonia mortality, found no evidence of widespread SARS-CoV-2 circulation in 2019. “During the period August-December 2019, review of all-cause as well as pneumonia-specific mortality surveillance data provided little evidence of any unexpected fluctuations in mortality that might indicate the occurrence of transmission of SARS-CoV-2 in the population before December 2019.”<sup>735</sup>

Relying on presentations by Chinese researchers, the WHO-China Report determined that there was explosive growth in COVID-19 cases by the third week of 2020 “indicating that widespread community transmission was occurring by the first week of January, 2020” but no evidence of SARS-CoV-2 transmission in October or November 2019 and reported only 174 confirmed infections of COVID-19 for all of December, 2019.<sup>736</sup> This finding stands in stark contrast to a *New England Journal of Medicine* article published on January 29, 2020 that concluded human-to-human transmission had occurred among close contacts since the middle of December 2019.<sup>737</sup> It is also inconsistent with multiple reports of Chinese government documents showing human COVID-19 in mid-November, 2019.<sup>738</sup>

Retrospective testing of stored biological samples in Wuhan hospitals from October to December 2019 tested negative. This reported data would be inconsistent with other information suggesting COVID-19 may have been circulating in Wuhan in this time period. By contrast, 2.2% of blood donations received by the Wuhan Blood Center between January and April 2020 tested positive for SARS-CoV-2 antibodies.<sup>739</sup> The WHO-China Joint Report recommended investigating options for testing blood donations received between September and December 2019 for SARS-CoV-2 antibodies.<sup>740</sup> To date, there is no publicly available information indicating that Chinese authorities have acted on the WHO team’s recommendations.<sup>741</sup>

Chinese officials retrospectively reviewed 76,253 cases of respiratory conditions from October and November 2019 from 233 healthcare facilities. “Following review by the health institutions” only 92 cases were reported as having symptoms consistent with COVID-19, “after review, subsequent testing, and further external multidisciplinary review” by Chinese officials, none of the suspected cases were infected with COVID-19.<sup>742</sup> It does not appear that PRC scientists retrospectively searched for non-hospitalized early COVID-19 cases despite knowing that less than 5% of COVID-19 cases required hospitalization. Thus, China’s only known effort to retrospectively search for undetected early COVID-19 cases would have failed to detect approximately 95% of COVID-19 cases. Data from the 76,253 cases was not made available to the joint WHO team nor was the clinical criteria used to eliminate cases described.<sup>743</sup>

Based on Chinese presentations, there is no evidence of SARS-CoV-2 circulation in people prior to December 2019. These findings are inconsistent with COVID-19 outbreak modeling, reports from U.S. Consulate officials in Wuhan, leaked PRC government documents identifying cases in November 2019, and other media reports of COVID-19 cases prior to December 2019. The seemingly limited retrospective



case search also stands in stark contrast to the testing and contact tracing investigations conducted by PRC government agencies as part of the government's "dynamic zero" COVID-19 policy.<sup>744</sup>

## 5. Animal Studies Searching for the Origins of SARS-CoV-2

As of early 2023, there is no reported evidence of SARS-CoV-2 or a closely related progenitor virus circulating in animals prior to the first publicly reported human infections in Wuhan in December 2019. Every outbreak of SARS-CoV-2 in animals is accepted as the result of human-to-animal transmission.<sup>745</sup> This is a departure from the precedent provided by SARS, where epidemiological investigations found a closely related virus (99.8% similar), lacking genetic mutations found in later human samples, circulating in palm civets and raccoon dogs in Guangdong wet markets within months of the first known human cases.<sup>746</sup> The failure to find any animal infected with a SARS-CoV-2 variant or closely related virus that lacks mutations found in human SARS-CoV-2 viral isolates is a significant evidentiary gap in the natural zoonotic hypothesis.

This section summarizes evidence from animal studies related to SARS-CoV-2's origins. This section is divided into two sub-sections. The first sub-section details the available evidence on animal surveys conducted by the PRC authorities during their investigation into the origins of SARS-CoV-2. These surveys reportedly did not find a single animal in China infected with SARS-CoV-2 either before or after the start of the COVID-19 outbreak. The second sub-section reviews studies on SARS-CoV-2 infections and transmission in various animal species, including experimental infections and natural infections caused by human-to-animal transmission of the virus. This sub-section also evaluates the leading candidate intermediate host species based on susceptibility to SARS-CoV-2 and evidence that the species was in the Huanan Market and Wuhan area live market supply chain.

### a. Animal Studies Conducted by PRC Public Health and Animal Health Officials.

According to presentations given by PRC officials to WHO's scientific advisory group for the origins of novel pathogens, PRC public and animal health authorities collected and analyzed over 80,000 animal samples from all 31 Chinese provinces and found no evidence of SARS-CoV-2 infections.<sup>747</sup> Many of the samples tested were collected as part of routine animal surveillance in 2018 and 2019.<sup>748</sup> Much of this surveillance appears focused on livestock and other animals, such as geese, duck, chicken, sheep, and pigs, which are important to the China's economy, its food security, and whose populations have experienced large scale outbreaks of infectious diseases in recent years.<sup>749</sup> However, none of these species are very susceptible to SARS-CoV-2 and thus are unlikely to be intermediate hosts of the virus.<sup>750</sup>

PRC officials reported that almost 12,000 geese, duck, chicken, sheep, cattle, and pig tissue samples collected in 2018-2019 tested negative for SARS-CoV-2 antibodies.<sup>751</sup> An additional survey of 26,807 of these animals using SARS-CoV-2 nucleic acid tests also reportedly found no evidence of infections.<sup>752</sup> PRC officials further reported to the WHO-China Joint Team that an undisclosed number of "wild animal samples collected and stored from 2015 to 2020 were all negative, and no anomaly was found in national surveillance system for wild animal disease."<sup>753</sup> None of the underlying data for the studies detailed above has been made publicly available.

In December, 2019, routine animal infectious disease surveillance in Hubei Province collected 2,328 samples from 69 animal species.<sup>754</sup> The survey included species susceptible to SARS-CoV-2, including raccoon dogs, skunks, foxes, deer, and several monkey species.<sup>755</sup> The information made available to the WHO-China Joint Team did not specify the number of samples collected from each species and included an entry on the list of animal species titled “etc.”<sup>756</sup> None of the samples tested positive for SARS-CoV-2 antibodies.<sup>757</sup>

The PRC also presented similar information on the results of 6,811 animal samples collected from 14 species as part of nationwide animal infectious surveillance in December 2019.<sup>758</sup> While many of the species sampled are not susceptible to SARS-CoV-2, samples were collected from an unknown number of ferrets, deer, and monkeys which have all proven to be highly susceptible to SARS-CoV-2.<sup>759</sup> As with other PRC animal survey data, none of the underlying data has been made publicly available.

A pre-print by Chinese researchers investigating SARS-CoV-2 infections in cats in Wuhan reported that 15 of 102 samples collected from cats in January to March 2020, after the start of the COVID-19, outbreak tested positive for the presence of SARS-CoV-2 with 11 cats also testing positive for SARS-CoV-2 antibodies.<sup>760</sup> None of the 39 pre-pandemic samples collected in March to May 2019, tested positive.<sup>761</sup> However, a separate study by Chinese researchers published in July 2020 collected 1,914 samples from 35 animal species in Wuhan “and surrounding areas” from November 2019 through March 2020.<sup>762</sup> All tested negative for SARS-CoV-2 antibodies, including several species of wild animals and companion animals that are susceptible to SARS-CoV-2.<sup>763</sup>

While preparing its preliminary report, the WHO’s SAGO received presentations from PRC researchers on animal surveys conducted in China since the WHO-China Joint Report was issued.<sup>764</sup> As with previous PRC presentations to the WHO, the underlying data was not made available. The SAGO Preliminary Report, published on June 9, 2022, noted that much of the material in the PRC’s presentations was unpublished.<sup>765</sup> Presentations to the SAGO on new animal studies in China included:

- A survey of known SARS-CoV-2 susceptible animals finding that Canine coronavirus in raccoon dogs in Changli and Leping in Hebei Province had a 94% identity (compared to the SARS-CoV-2 virus) however, there were no positive SARS-CoV-2 samples captured (unpublished data presented to the SAGO).<sup>766</sup>
- Initial animal testing of 32,479 animal samples (species and numbers of species were not specified) from 18 provinces in China, did not find any nucleic acid-positive tests for SARS-CoV-2.<sup>767</sup>
- Serologic results from 1,211 serum samples from livestock and poultry and 2,837 serum samples from dogs, cats, mink, foxes and racoons were presented suggesting no positive results for SARS-CoV-2 antibodies (unpublished data presented to the SAGO).<sup>768</sup>

As of early 2023, the underlying data from these presentations remains unpublished.

As part of the argument that SARS-CoV-2 did not originate in China, PRC government officials and scientists continue to claim that there have been no widespread outbreaks of SARS-CoV-2 in the country's animal population despite regular large scale animal testing. Unlike other countries, the PRC has not reported culling any farmed animals.<sup>769</sup> Prior to 2022, PRC officials have only reported isolated infections among companion animals.<sup>770</sup> Similarly, 2022 has seen reports of mass culling of pet hamsters, dogs, and other companion animals, but no reports on mass animal infections.<sup>771</sup> A case report showed that SARS-CoV-2 infection in a pet hamster resulted in hamster-to-human infection leading to sustained human-to-human SARS-CoV-2 transmission.<sup>772</sup>

#### **b. SARS-CoV-2 Infections in Animals**

With the global spread of SARS-CoV-2, scientists conducting infectious disease surveillance in animals outside of China have been able to study the spread of SARS-CoV-2 among multiple animal species either through natural human-to-animal infections or through infection experiments by scientists. Overlaying the results these studies and experiments with evidence of live animal sales in the Huanan Market and other Wuhan area markets during the early COVID-19 outbreak can identify which of the animals susceptible to SARS-CoV-2 are the candidate intermediate hosts, if the zoonotic origin hypothesis is to be proven valid.

##### **i. Experimental Infections of SARS-CoV-2 and Related Studies**

SARS-CoV-2 is a generalist virus that can infect a wide variety of animal species.<sup>773</sup> Scientists attempting to identify potential intermediate hosts for SARS-CoV-2 have undertaken infection experiments ranging from ACE2 affinity experiments to animal infection studies. ACE2 experiments showed, surprisingly, that early pandemic SARS-CoV-2's spike protein bound most strongly to human ACE2 receptors, while exhibiting high binding affinity for primates and a large number of mammals and low affinity to bats.<sup>774</sup> Studies of experimental COVID-19 infections in animals also indicate that the most likely intermediate hosts for SARS-CoV-2 are mammals (Table 7).

Table 7. Susceptible animals to SARS-CoV-2 identified through experimental means

Animal Species	Susceptibility (a)	Intra-species transmission**
African green monkeys ( <i>Chlorocebus aethiops</i> )	Yes	Not specified
Baboons ( <i>Papio hamadryas</i> )	Yes	Not specified
Bank voles ( <i>Myodes glareolus</i> )	Yes	No
Bushy-tailed woodrats ( <i>Neotoma cinerea</i> )	Yes	Not specified
Campbell's dwarf hamster ( <i>Phodopus campbelli</i> )	Yes	Not specified
Cat ( <i>Felis silvestris catus</i> )	Yes	Yes
Cattle ( <i>Bos taurus</i> )	Yes (Low susceptibility)	No
Chinese hamster ( <i>Cricetulus griseus</i> )	Yes	Not specified
Common marmosets ( <i>Callithrix jacchus</i> )	Yes	Not specified
Cynomolgus macaques ( <i>Macaca fascicularis</i> )	Yes	Not specified
Deer mice ( <i>Peromyscus maniculatus</i> )	Yes	Yes
Dog ( <i>Canis lupus familiaris</i> )	Yes (Low susceptibility)	No
Egyptian fruit bat ( <i>Rousettus aegyptiacus</i> )	Yes	Yes
Ferret ( <i>Mustela furo</i> )	Yes	Yes
Goat ( <i>Capra hircus</i> )	Yes (Low susceptibility)	Not specified
Mice - BALB/c and C57BL/6 *	Yes	Yes (mouse adapted)
Mice - Transgenic hACE2*	Yes	Not specified
Mink ( <i>Neovison vison</i> )	Yes	Yes
Pig ( <i>Sus scrofa domestica</i> )	Yes (Low susceptibility)	No
Rabbit ( <i>Oryctolagus cuniculus</i> )	Yes	Not specified
Raccoon dogs ( <i>Nyctereutes procyonoides</i> )	Yes	Yes
Rat - Sprague Dawley*	Yes	Not specified
Red Fox ( <i>Vulpes vulpes</i> )	Yes	Not specified
Rhesus macaques ( <i>Macaca mulatta</i> )	Yes	Not specified
Roborovski hamster ( <i>Phodopus roborovskii</i> )	Yes	Not specified
Sheep ( <i>Ovis aries</i> )	Yes (Low susceptibility)	No
Striped skunks ( <i>Mephitis mephitis</i> )	Yes	Not specified
Syrian hamster ( <i>Mesocricetus auratus</i> )	Yes	yes
Crab-eating macaque ( <i>Macaca fascicularis</i> )	Yes	Not specified
Tree shrews ( <i>Tupaia belangeri chinensis</i> )	Yes	Not specified
White-tailed deer ( <i>Odocoileus virginianus</i> )	Yes	Yes
Winter white dwarf hamster ( <i>Phodopus sungorus</i> )	Yes	Not specified
Zebra fish ( <i>Danio rerio</i> )	Yes	Not specified
Zebra mussel ( <i>Dreissena polymorpha</i> )	Yes	Not specified

\*\*Not specified means not having proof of transmission.

Source: <https://cdn.who.int/media/docs/default-source/scientific-advisory-group-on-the-origins-of-novel-pathogens/sago-report-09062022.pdf>

## ii. Animals Susceptible to SARS-CoV-2 Through Natural Infections

As the China-WHO Joint Report noted, a consequence of SARS-CoV-2's broad tropism in mammals is that there are many potential intermediate host species:

SARS-CoV-2 infection and intraspecies spread (including further transmission to humans) has been documented in an increasing number of animal species, particularly mustelids and felids. SARS-CoV-2 adapts relatively rapidly in susceptible animals (such

as mink). The increasing number of animals shown to be susceptible to SARS-CoV-2 includes animals that are farmed in sufficient density to allow for enzootic circulation.<sup>775</sup>

Animal infectious disease surveillance has discovered SARS-CoV-2 infections in a wide range of animals including: otters, lynx, mink, domestic cats, domestic dogs, ferrets, hamsters, lions, pumas, snow leopards, hyenas, tigers, gorillas, and deer.<sup>776</sup> These animals have been infected in a variety of settings ranging from industrial animal farms to zoos and the wild.<sup>777</sup>

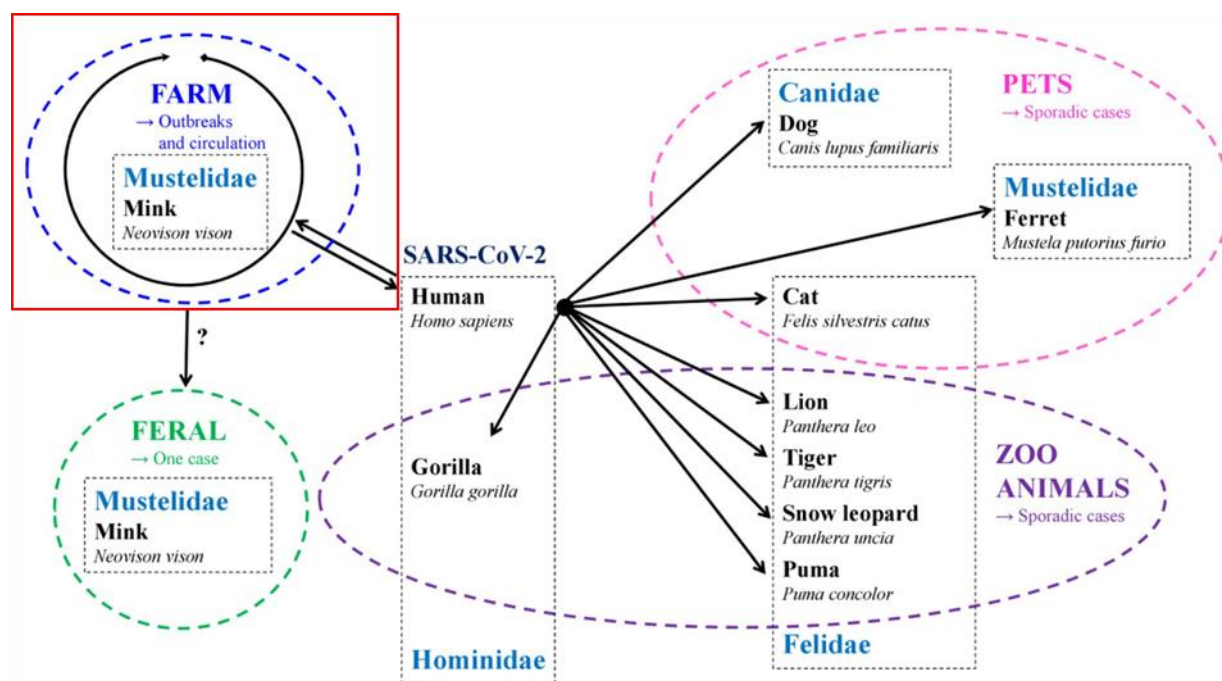

Figure 41. Figure adapted from Fenollar F, Mediannikov O, Maurin M, Devaux C, Colson P, Lvasseur A, Fournier P-E and Raoult D (April 1, 2021) Mink, SARS-CoV-2, and the Human Animal Interface. *Front. Microbiol.* 12:663815 <https://doi.org/10.3389/fmicb.2021.663815>.

As expected, given the results of experimental infections, susceptible animals are all mammals with most being cats (*felids*), mink or small rodents (*mustelid*), or non-human primates (*simians*).

## 6. Analysis of Mink, Raccoon Dogs, and Foxes as Candidate Intermediate Hosts for SARS-CoV-2 Outbreaks

The most important evidence for live animal sales at the Huanan Seafood Market is the Xiao survey of Wuhan area markets establishing that the Huanan Seafood Market and others “traded many thousands of live wild animals including high-risk species” in the months prior to the COVID-19 outbreak.<sup>778</sup> Mammals susceptible to SARS-CoV-2 that were recorded at Wuhan area wet markets from May 2017 to November 2019 include: mink, weasels, raccoon dogs, masked palm civets, Chinese munt and badgers.<sup>779</sup> Of the mammal species in Xiao survey, mink, foxes, and raccoon dogs represent the most likely intermediate hosts of SARS-CoV-2.<sup>780,781</sup>

### a. Natural Infections of SARS-CoV-2 in Farmed Mink

The first COVID-19 outbreaks in mink was detected in mid-April, 2020 at two mink farms in the Netherlands, located approximately 8.5 miles apart.<sup>782</sup> A majority of infected animals only displayed mild symptoms, but the two farms did report a notable rise in animal deaths from the 0.6% to 1.2% and 2.4% respectively.<sup>783</sup> The outbreak investigation found “no connection of workers, vehicles or animal transports, between these two farms.”<sup>784</sup> Viral sequences collected from mink samples were consistent with human to mink transmission of the virus.<sup>785</sup> Individuals working at the farms also reported COVID-19 like symptoms before the illness was reported in minks and environmental sampling show that SARS-CoV-2 was present in dust from the mink’s bedding.<sup>786</sup> As result of these findings, it was concluded that the outbreaks were most likely the result of separate introductions from farm workers.<sup>787</sup>

As these first outbreaks were being investigated, industrial mink farms in Europe and North America began experiencing explosive COVID-19 outbreaks.<sup>788</sup> In the Netherlands outbreak occurred at over 60 mink farms with the Dutch government culling infected mink beginning in June, 2020.<sup>789</sup> When culling infected mink failed to contain the outbreak, the Dutch government ordered the culling of all farmed mink in November, 2020 and instituted a ban on mink farming.<sup>790</sup> COVID-19 outbreaks among farmed mink have been reported in over 15 countries, including, the United States, Denmark, Poland, France, Sweden, Spain, and Italy.<sup>791</sup>

Once SARS-CoV-2 enters a mink farm’s animal population, it spreads rapidly, and it is not uncommon for all samples collected at a given farm to test positive for SARS-CoV-2.<sup>792</sup> One study found that only 12% of farms experiencing a COVID-19 outbreak had less than 50% of their samples test positive.<sup>793</sup> Rapid, widespread transmission of SARS-CoV-2 among farmed mink populations has resulted in the virus mutating, leading to the emergence of mink specific SARS-CoV-2 variants.<sup>794</sup> In addition, studies have shown that mink can be re-infected with SARS-CoV-2 approximately every six months, which sustains transmission of the virus within an impacted farm and presents more opportunities for the virus to mutate.<sup>795</sup>

As of September 25, 2022, farmed mink are the only animal with confirmed instances of animal to human transmission of SARS-CoV-2. A Dutch study of a COVID-19 outbreak across 16 mink farms found that the virus was initially introduced into the farms by humans several weeks before the outbreaks were detected.<sup>796</sup> The resulting widespread circulation of SARS-CoV-2 among mink on the farms caused the virus to quickly evolve so as to adapt to the mink.<sup>797</sup> Sixty eight percent of mink farm residents, employees and close contacts had evidence of SARS-CoV-2 infection.<sup>798</sup>

Sequencing of available whole virus genomes from infected humans showed that the individuals had been “infected with strains with an animal sequence signature, providing evidence of animal-to-human transmission of SARS-CoV-2 within mink farms.”<sup>799</sup> By November 2020, Denmark had reported 214 human COVID-19 infections caused by mink variants of SARS-CoV-2.<sup>800</sup> In April 2021, European scientists discovered a mink variant of SARS-CoV-2 that had undergone significant mutations in its spike protein, allowing the variant to evade COVID-19 therapeutics and natural immunity. These findings prompted the Danish government to cull its entire population of 17 million farmed mink in an effort to prevent mink variants from crossing over into humans.<sup>801</sup>

## b. Animal and Fur Farming in the PRC

The PRC is home to world's largest fur farming industry, including the world's largest stock of farmed mink at just over 20 million animals, representing 53% of global production.<sup>802</sup> Beyond mink, the PRC is by far the world's largest producer of raccoon dogs and foxes, producing 14 and 13 million pelts respectively per year.<sup>803</sup> The PRC's fur industry employs around 7 million people and, in 2017, the PRC's fur industry accounted for \$17 billion in global fur retail sales out of \$30 billion in annual sales.<sup>804</sup>

The expansion of the PRC's fur farming industry from 2010 through 2017 has resulted in a glut of furs on the global market that has reduced profits, forced farmers to implement cost cutting measures, and pushed some smaller farms out of business.<sup>805,806</sup> Geographically, mink farming is concentrated in Shandong Province with fox and raccoon dog production concentrated in Hebei Province. Fur processing and wholesale market are geographically concentrated in the PRC's coastal provinces and Hong Kong.<sup>807</sup> Hubei province is not considered a major fur farming province.



Figure 42. Major fur farming, processing and wholesale areas in China.

Source: ActAsia (2019) *China's fur trade and its position in the global fur industry* <https://www.actasia.org/wp-content/uploads/2019/10/China-Fur-Report-7.5.pdf>

Unlike fur farming in North America and Europe which is concentrated in large farms, fur farming in the PRC is predominately carried out by small household farms that typically produce between 300 and 1,000 fur bearing animals per year.<sup>808</sup> Even with increasing consolidation and professionalization, 46% of China's mink farms are small household farms.<sup>809</sup> While China's fur industry has begun adopting some fur farming standards and other practices from Europe, "China lacks mandatory regulations, common in other farming countries. Without penalties, animal welfare, environmental standards, and human health remain compromised."<sup>810</sup>

Animal welfare and working conditions in PRC's fur farming industry are poor and, thus conducive to the spread of infectious diseases.<sup>811</sup> Farmed fur bearing animals are held in smaller cages than those found at equivalent European fur farms.<sup>812</sup> Other poor welfare conditions are commonplace:

Stereotypical captive behaviour has been witnessed at every fur farm investigated in China. This includes self-mutilation, infanticide, and repetitive pacing, witnessed across the board of all farms investigated in China. Cub mortality is high. ... [A]nimals are commonly found in isolation, unable to make physical contact with others.... Food is given as a processed paste. Wire bases to cages lead to injuries from limbs becoming caught, especially with young animals.... Cages in Chinese fur farms have been found to be barren, exposed to the elements whether the climate is cold or hot, and severely inadequate in providing shelter or comfort, serving only to keep captives alive for long enough to grow a pelt of acceptable size.<sup>813</sup>

Inbreeding is a widespread practice as it quickly increases the number of animals but makes populations susceptible to disease and reduces fur quality, further driving down prices for farmers and pushing farmers to increase production.<sup>814</sup>

A 2010 USDA reports found that “under the pressure of increase feed costs” mink and other fur bearing animals are feed a poor diet.<sup>815</sup> More recent reporting suggests that fur farmers in China regularly feed the remains of skinned animals to the next generation of animals.<sup>816</sup> Skinned by-product of minks, raccoon dogs, and foxes are also sold to meat traders or consumed by the farm owner and farm workers.<sup>817</sup>

Most farmed mink, raccoon dogs, and foxes in China are skinned alive by hand usually after being bludgeoned in the head in an attempt to render the animal unconscious.<sup>818</sup> Live-skinning is used because it is cheaper for small household fur farms to hire labor than to invest in equipment required for more humane killing methods.<sup>819</sup> As a result, China has a large number of migratory workers in the fur farming industry. During skinning season, which runs from October to December, these “mobile skinners” move from farm to farm, slaughtering and skinning animals as fast as they can.”<sup>820</sup>





Figure 43. Photos of mink farming in China. Source: ActAsia (2019) China's fur trade and its position in the global fur industry <https://www.actasia.org/wp-content/uploads/2019/10/China-Fur-Report-7.5.pdf>

The Xiao survey found that the Huanan Market and other Wuhan area markets sold raccoon dogs, minks, weasels and foxes makes them strong candidate intermediate hosts given the condition prevalent at Chinese fur farms. Widespread COVID-19 outbreaks at mink farms in North America and Europe, as well as documented cases of interspecies transmission between mink and humans, make mink the leading candidate intermediate host species.

However, PRC government officials have denied that any Chinese animal farms have experienced COVID-19 outbreaks. In presentations given to the WHO-China Joint Team, PRC animal health officials reported, that on December 7, 2019, a “scientific research team”<sup>17</sup> collected samples from 69 kinds of farmed wild animals in Hubei Province with a total of 2,328 samples collected.<sup>821</sup> All samples were negative for SARS-CoV-2 according to the presentation. Similar sampling expeditions targeting wild animals in Hubei Province also reported no samples were positive for SARS-CoV-2.<sup>822</sup> Nationwide animal sampling surveys conducted in China have not reported a single SARS-CoV-2 infected farmed animal, including among species known to be susceptible to SARS-CoV-2.<sup>823</sup> However, the underlying data from those surveys has not been made public.

<sup>17</sup> The presentation to the WHO-China Joint Team does not identify the pre-COVID-19 purpose of this sample collection, which predates the PRC's announcement of the COVID-19 outbreak by nearly a month. By contrast, other presentations to the Joint Team, specify that samples collected prior to the identification of the COVID-19 note that the samples were collected as part of routine disease surveillance or for some other research purpose.

## Chapter 6: Evidence of a Natural Zoonotic Origin for SARS-CoV-2 & Outstanding Questions

### Introduction

This chapter examines the available public evidence in support of the zoonotic origin's hypothesis for SARS-CoV-2. It is organized into two sections. The first section outlines the hypothetical routes for the zoonotic spillover of SARS-CoV-2 from its viral reservoir in horseshoe bats in Southern China and Southeast Asia to Wuhan. The second section identifies the critical evidentiary gaps that prevent this investigation from concluding that the COVID-19 pandemic is the result of the natural zoonotic spillover of SARS-CoV-2. The third section details outstanding questions that, if answered, would increase confidence in the possibility of a zoonotic origin for the pandemic.

#### 1. Hypothetical Zoonotic Spillover of SARS-CoV-2

If the COVID-19 pandemic is the result of the zoonotic spillover of SARS-CoV-2 then somewhere SARS-CoV-2 or a progenitor virus spilled over from its unidentified reservoir bat species either directly into humans or into an unidentified intermediate host species who then transmitted the virus to humans. SARS-CoV-2 is descended from bat coronaviruses.<sup>824</sup> Its progenitor virus naturally circulates in horseshoe bats, in Southern China or Southeast Asia.<sup>825</sup> Bat populations native to Hubei Province are not known to carry viruses closely related to SARS-CoV-2 making it unlikely that the spillover from a bat to an intermediate host occurred there.<sup>826</sup>

Based on precedent and genomics, the scenario for a zoonotic origin of the COVID-19 pandemic is that SARS-CoV-2 crossed over the species barrier from an intermediate host to humans.<sup>827</sup> However, the available evidence is also consistent, perhaps more so, with a direct bat to human spillover. Both scenarios remain plausible and, in the absence of additional information, should be considered equally valid hypotheses.<sup>828</sup>

##### a. Transmission from Intermediate Host to Human Hypothesis

Under this sub-hypothesis, in late-2019 one or more unidentified animals infected with SARS-CoV-2 or a progenitor virus encountered humans. Between mid-October and early to mid-November 2019, SARS-CoV-2 successfully spilled over from the yet-unidentified intermediate host into humans, with the virus becoming established in humans within weeks of the spillover. Based on precedent and the animals most susceptible to SARS-CoV-2 infections, this intermediate host is one or more species of mammals common in the live wildlife trade or fur farming in China.<sup>829</sup> However, where the spillover from intermediate host to human occurred and what the intermediate host species was are unknown.<sup>830</sup>

There are two plausible scenarios involving an intermediate host. The first is that this unidentified infected animal, acting as an intermediate host, carried SARS-CoV-2 into Wuhan or the surrounding area and from there it spilled over into humans.<sup>831</sup> This is what occurred during SARS where palm civets infected with the virus were distributed to multiple wet markets across southern China which then

experienced near simultaneous outbreaks.<sup>832</sup> The second scenario is that the intermediate host to human spillover occurred closer to SARS-CoV-2's likely viral reservoir in southern China or Southeast Asia and that an infected human (the index case) then traveled to Wuhan shortly after being infected. This hypothesis imitates how SARS-CoV-2 spread by human-to-human transmission from China to the rest of the world in early 2020.<sup>833</sup>

Regardless of the specific route of transmission through an intermediate host, the process of adapting to an intermediate host species can spur mutation and recombination events that can increase the chances of the virus infecting other species related to the intermediate host.<sup>834</sup> Passage through a mammal could explain how SARS-CoV-2 became so efficient at infecting a wide range of mammalian species, including humans.<sup>835</sup> SARS-CoV-2 could have acquired its unique furin cleavage site during circulation in an intermediate host.<sup>836</sup> Adaptation in an intermediate host may also explain the evolutionary distance between SARS-CoV-2 and other closely related viruses.<sup>837</sup>

Epidemiological modeling and reports of early COVID-19 cases converge on mid-October to mid-November 2019 as the timeframe for the spillover of SARS-CoV-2. Based on the publicly available evidence, Wuhan is the only location where SARS-CoV-2 spilled over into humans. This creates two possibilities. That the spillover that precipitated the COVID-19 pandemic occurred exclusively in Wuhan or the surrounding area. Alternatively, that the spillover occurred somewhere other than Wuhan, but Wuhan is the only known location where successful human-to-human transmission occurred. The low genetic diversity of earliest SARS-CoV-2 samples, coupled with lineage A being more closely related to bat coronaviruses, suggests that COVID-19 pandemic is most likely the result of a single successful introduction of SARS-CoV-2.<sup>838</sup>

Although, the possibility of two independent introductions cannot be ruled out. The available epidemiology from the early outbreak in Wuhan suggests the introduction of SARS-CoV-2 into humans was likely from a continuous common source.<sup>839</sup> This means that over a period a single infection source (whether one or more members of an intermediate host species or a human) infected multiple people in Wuhan. These early Wuhan cases then seeded the virus throughout Wuhan. This continuous common source could be a specific population of animals found in the supply chain of Wuhan area markets. The continuous common source could also be an infected individual who then traveled to Wuhan.

#### **i. SARS-CoV-2 Arrives in Wuhan in an Intermediate Host**

Hubei Province is not a major fur producing province, but it is a major transit hub and is located immediately adjacent to several major fur producing provinces.<sup>840</sup> Hubei is also home to animal farms that produce raccoon dogs, ferrets, badgers, civets and other mammals susceptible to SARS-CoV-2, though the scope and scale of animal farming in Hubei is unclear.<sup>841</sup> There have been media reports of mass culling of farmed animals in western-Hubei Province, but no official PRC government reports of such actions.<sup>842</sup> The unclassified intelligence assessment on the origins of SARS-CoV-2 also mentions that “[w]ider Hubei Province has extensive farming and breeding of animals that are susceptible to SARS-CoV-2, including minks and raccoon dogs.”<sup>843</sup>

The precedent of SARS, SADS, and avian influenza suggests the spillover is likely to have occurred in the live animal supply chain for Wuhan area animal markets, in one or more markets, warehouses or farms.<sup>844</sup> Many but not all of the earliest cases were associated with Huanan Seafood Market, which also contained a number of positive environmental samples.<sup>845</sup> At least one other market and an unknown number of warehouses that supplied the market also had positive environmental samples.<sup>846</sup> There were reportedly no positive “animal-related” samples recovered from the Huanan Seafood Market.<sup>847</sup> **Despite evidence of live animal sales of species susceptible to COVID-19, PRC authorities have denied live animal sales involving small mammals occurred at the Huanan Seafood Market.**<sup>848</sup>

**In actuality, it appears that there were live animal sales at Huanan Seafood Market, albeit in relatively small numbers.**<sup>849</sup> **Therefore, animals present at the market when it was closed were either not tested or their test results have not been made public.**<sup>850</sup> **None of the animals tested from the Huanan Seafood Market’s supply chain, or in China’s animal farming industry were infected with SARS-CoV-2 according to presentations by PRC government officials and scientists made to the WHO.**<sup>851</sup> **While precedent makes the involvement of an intermediate host animal the most likely scenario, there is little direct evidence suggesting the involvement of an intermediate species in SARS-CoV-2’s emergence, including no evidence of animals in Hubei province being infected with SARS-CoV-2 prior to the first human cases.**<sup>852</sup>

Unlike SARS or avian influenza outbreaks, after the continuous common source stopped transmitting SARS-CoV-2, there have been no other independent introductions of pre-human animal variants of SARS-CoV-2.<sup>853</sup> Precedent suggests that spillovers of SARS-CoV-2 from an intermediate host species into humans should have continued where the index case was infected.<sup>854</sup> These human infections and continued spread of the disease in the intermediate host population should have resulted in additional variants and caused outbreaks in other locations.<sup>855</sup> Even if these other variants were ultimately outcompeted by lineage A and B, there should be at least some evidence that they existed. This was the pattern seen in SARS, SADS, and H7N9. This is not the pattern seen with SARS-CoV-2.

**Based on the available evidence Wuhan is the only location where SARS-CoV-2 spilled over into people and the virus had only one or two successful introductions.**<sup>856</sup> **After these two introductions the unidentified source stopped transmitting SARS-CoV-2 and left no evidence of it having been infected.**<sup>857</sup> If the COVID-19 pandemic is the result of the zoonotic spillover of SARS-CoV-2 in Wuhan from an intermediate host species, there should be evidence in the market supply chain or farms of SARS-CoV-2 circulating in animals before it spilled over into humans. Instead, there is no evidence of an animal infected with SARS-CoV-2 prior to the first human cases.<sup>858</sup>

## **ii. SARS-CoV-2 Arrives in Wuhan via an Infected Human**

An alternative hypothesis involving an intermediate host is that a person was infected with SARS-CoV-2 (the “index case”) from an unidentified intermediate host species outside of Wuhan before then traveling to Wuhan and propagating the virus there. This hypothesis imitates how SARS-CoV-2 spread by human-to-human transmission from China to the rest of the world in early 2020.<sup>859</sup> Such an event would also explain the failure to find any evidence of SARS-CoV-2 infections in animals tested

from Wuhan and Hubei Province.<sup>860</sup> Under this scenario, the continuous common source leading the COVID-19 outbreak in Wuhan is an infected individual who transmitted the virus only as long as they are contagious, but may have spread the virus to multiple locations around Wuhan during their period of infectivity.

This scenario is consistent with the early epidemiology showing rapid spread of the virus in multiple areas of Wuhan.<sup>861</sup> Moreover, the Huanan Seafood Market is located in central Wuhan, approximately half a mile from Wuhan's main train station which is a major high speed rail hub for China.<sup>862</sup> If the hypothetical index case arrived in Wuhan via train or took the subway from the airport, it is possible that some of the first people he or she infected would have worked, lived, or passed through the area around the train station and Huanan Seafood Market. If this scenario were true, the large number of early COVID-19 cases with links to the Huanan Seafood Market would represent a human super spreader event caused by an infected person, consistent with the genetic evidence showing that the SARS-CoV-2 samples collected from the Huanan Market were lineage B virus.<sup>863</sup>

This theory would also explain the low genetic diversity of the earliest known SARS-CoV-2 human infections in Wuhan because the index case is the only source of the virus in Wuhan.<sup>864</sup> This scenario explains the failure to find an intermediate animal host species in Wuhan or the surrounding Hubei Province. What it cannot fully account for is the failure to find any evidence of an intermediate host or any animal infected with SARS-CoV-2 prior to humans as the index case would have had to encounter an infected animal somewhere. Given SARS-CoV-2's ability to infect and transmit within multiple species of animals, it is unlikely that the virus could ever be eradicated, without a major intervention like mass culling, once it began spreading in one or more susceptible intermediate host populations.<sup>865</sup>

It may be more difficult to locate the intermediate host if it is located in southern China, near SARS-CoV-2's likely viral reservoir, than if it was near Wuhan where the outbreak occurred. However, this hypothetical does not provide a satisfactory answer for the failure to find any evidence of any animal in China or Southeast Asia infected prior to the first human COVID-19 cases. Similarly, SARS-CoV-2 would be expected to continue to circulate in the infected intermediate host population creating the potential of additional independent introductions into humans and other animals.<sup>866</sup> This is what occurred during SARS, where infected palm civets transmitted the virus to humans and to raccoon dogs.<sup>867</sup> SARS was only brought under control due to a combination of public health measures slowing its spread in humans and mass culling of infected and susceptible animals.<sup>868</sup> If the COVID-19 pandemic is the result of a zoonotic spill over from an intermediate host of SARS-CoV-2, it appears that SARS-CoV-2 stopped circulating in that unidentified host after successfully spilling over into people without leaving any evidence in animals of past circulation.

#### **b. Direct Bat to Human Transmission Hypothesis**

Alternatively, SARS-CoV-2 may have spilled directly from bats into humans. The prevailing scientific view is that SARS-related coronaviruses need the adaptation phase offered by an intermediate host in order to spur mutations or allow for recombination events that increase the virus' chances of being able to infect and replicate in humans. Adaptation during circulation in an intermediate host is believed to

have played a critical role in the emergence of SARS and MERS, as well as other bat viruses such as hendra and Nipah virus.<sup>869</sup> While direct bat to human spillover of coronaviruses has never been confirmed to cause a human outbreak, it is theoretically possible and there is circumstantial evidence suggesting it may occur under certain circumstances.<sup>870</sup>

Serological surveys of residents of rural areas of Yunnan province, conducted by the WIV and EcoHealth Alliance, in October 2015 found that 6 of 218 (2.75%) individuals screened tested positive for coronavirus antibodies.<sup>871</sup> The individuals tested lived within 6 km of two caves that the WIV had identified as being “inhabited by large numbers of bats” including the Chinese horseshoe bat, which is a “major reservoir” of SARS-related coronaviruses.<sup>872</sup> Notably, the control blood samples came from Wuhan, “[a]s a control, we also collected 240 serum samples from random blood donors in 2015 in Wuhan, Hubei Province is more than 1,000 km away from Jinning and where inhabitants have a much lower likelihood of contact with bats due to its urban setting.”<sup>873</sup>

The positive antibody samples did not neutralize the two SARS-related viruses they were exposed to, WIV1 and WIV16.<sup>874</sup> This suggested either weak immune response or that the SARS-related virus that infected these six people was sufficiently different from WIV1 and WIV16 that those viruses evaded antibody response. None of the six people with positive samples reported any symptoms consistent with SARS in the previous 12 months. In conclusion the researchers observed:

The 2.7% seropositivity for the high-risk group of residents living near bat colonies suggests that spillover is a relatively rare event, however this depends on how long antibodies persist in people, since other individuals may have been exposed and antibodies waned.... However, considering that these individuals have a high chance of direct exposure to bat secretion in their villages, this study further supports the notion that some bat SARS-related viruses can directly infect humans without intermediate hosts, as suggested by receptor entry and animal infection studies.<sup>875</sup>

SARS-CoV-2's high binding affinity for human ACE2 receptors suggests that it is possible for SARS-CoV-2 to directly infect humans without needing a period of adaption in an intermediate host.<sup>876</sup> SARS-related virus BANAL-236 has a spike protein that is 96.9% similar to that of SARS-CoV-2 and has been found to infect human cells under experimental conditions.<sup>877</sup> BANAL-236 has also been shown to infect and replicate in humanized mice and macaques during experiments and infection offers some protection against SARS-CoV-2.<sup>878</sup> In both humanized mice and macaques, BANAL-236 is an enteric virus, however, infecting and replicating in the stomach and shedding virus through feces.<sup>879</sup>

By contrast SARS-CoV-2 is a respiratory virus that infects and replicates efficiently in the lungs and upper respiratory tract.<sup>880</sup> BANAL-236 does not have a furin cleavage site like SARS-CoV-2, which may explain its failure to effectively replicate in lungs and the respiratory system. Efforts by scientists to see if BANAL-236 would naturally introduce a furin cleavage site have been unsuccessful. After several serial passages through humanized mice, BANAL-236 did not produce a furin cleavage site.<sup>881</sup>

These results suggest that early strains of SARS-CoV-2 may have circulated undetected as an enteric virus in humans until it acquired the furin cleavage site, likely through mutation, allowing it more

efficiently transmit as a respiratory virus.<sup>882</sup> However, the fact that six serial passages in humanized mice failed to cause BANAL-236 to generate a furin cleavage site is some evidence that SARS-CoV-2 would be unlikely to have acquired its furin cleavage site while circulating in humans and that circulation in an intermediate host occurred.<sup>883</sup>

Of note, the research team that discovered the BANAL series viruses also conducted serological studies of humans living in close contact with bats infected with SARS-related coronaviruses and found no evidence of direct bat to human spillover. “We did not find evidence of human infection in contact with bat, in contrast with previous observations that used less specific [antibody tests], which supports the hypothesis that BANAL viruses are highly transmissible neither from bats to humans nor between humans.”<sup>884</sup> These findings indicate that the results of the WIV and EcoHealth’s 2015 serological survey from Yunnan province may be a false positive and is further evidence that direct bat to human spillover is an extremely rare event if it happens at all.

Nevertheless, if direct bat to human spillover is possible, once the infected person reached Wuhan, the subsequent outbreak would be like the scenario outlined above where the index case is infected by an intermediate host and then travels to Wuhan. Direct spillover from a bat better explains the epidemiological evidence, most importantly the failure to find an intermediate host anywhere.<sup>885</sup> It also explains the failure to find any animal infections pre-dating human COVID-19 cases as, under this hypothetical humans are the intermediate host passing the virus to other animals. Finally, direct bat to human spillover explains the lack of genomic signatures in the early COVID-19 human cases indicating the involvement of other animal species in the emergence of SARS-CoV-2, including why SARS-CoV-2 had the highest affinity for binding to human ACE2 receptors.<sup>886</sup>

Challenging this possibility are the facts that bats were not sold in Huanan Market. Significantly, bats are not customarily eaten by residents of Wuhan. Finally, the risk of bat exposure leading to SARS-related illness was considered remote by WIV researchers; so much so, that Wuhan residents were used as negative controls for serological analysis in human SARS antibody prevalence studies.

It is unlikely that the bat to human spillover would have occurred in Wuhan or Hubei Province as the bat populations there do not appear to harbor viruses like SARS-CoV-2.<sup>887</sup> It is more likely that an individual in Southern China or Southeast Asia was infected and then traveled to Wuhan. As observed previously, Wuhan is a major travel hub. One of the six individuals who tested positive for SARS-related virus antibodies in the WIV’s 2015 serological survey reported that, in the 12 months prior to the sample being taken, she had traveled to Shenzhen, located approximately 1,400 kms from her village.<sup>888</sup>

It is not impossible to imagine a scenario where the SARS-CoV-2 index case was infected directly by a bat in rural Yunnan province then travels to Wuhan during their period of infectivity and seeded the virus throughout the city. This is exactly how individuals infected in Wuhan later spread the virus to the rest of China and then globally. If the individual remained asymptomatic or mildly symptomatic, which is the case for around 80% of COVID-19 cases, the person may not have realized that they were sick with anything more than the common cold.<sup>889</sup>

## 2. Outstanding Questions in the Zoonotic Origins Hypothesis

### a. Where is SARS-CoV-2's Viral Reservoir?

SARS-CoV-2's ancestor is a bat coronavirus residing in horseshoe bat colonies located in Southern China and Southeast Asia. The coronaviruses discovered to date that are most closely related to SARS-CoV-2 are all bat coronaviruses discovered in species of horseshoe bats in southern China and Southeast Asia, including Yunnan Province, Laos, Thailand and Cambodia.<sup>890</sup> Moreover, bat surveys from Hubei Province indicate that the horseshoe bat population in Hubei are not infected with coronaviruses closely related to SARS-CoV-2.<sup>891</sup>

The failure to locate the viral reservoir for SARS-CoV-2 is not unexpected. It took almost 12 years for scientists to find the cave containing the progenitor viruses for SARS.<sup>892</sup> Other zoonotic viruses with origins in remote, sparsely populated and developed parts of the world have taken decades to trace back to their location of their viral reservoirs.<sup>893</sup> The exact location of the viral reservoirs for most zoonotic viruses, including viruses like Ebola and HIV, remain unknown.<sup>894</sup> The sheer size of the geographic area where SARS-related viruses have been found coupled and the remote location of the most likely colonies means that finding the exact cave or caves where SARS-CoV-2 originated may take years to uncover, if ever.

### b. What was the role of the Huanan Seafood Market?

The Huanan Seafood Market COVID-19 cases and environmental samples were most likely the result of an early human-to-human super spreading event. According to the CCDC on January 19, 2020, only 43 (22%) of the 198 confirmed cases in its outbreak investigation had been exposed to the Huanan seafood wholesale market.<sup>895</sup> Most of the earliest known COVID-19 cases have no link to the Huanan Market. The earliest symptom onset date for Huanan market associated COVID-19 cases is December 10, 2019, which is several weeks after the period when the pandemic began. The case definitions used by PRC public health officials during the early outbreak in January and February 2020, would have missed over 90% of COVID-19 cases. If accurately described retrospective case searches by PRC public health officials also failed to consider asymptomatic and mildly symptomatic cases, thus again missing around 90% of COVID-19 cases.

The apparent failure to either test animals found at the market or, if tested, to share test results is a major failure of transparency.<sup>896</sup> COVID-19 cases among market vendors and commercial buyers were concentrated among seafood and vegetable vendors, not animal vendors.<sup>897</sup> While live animal sales occurred at the Huanan Market, it appears to be a relatively small portion of the market's business with at most only 15 of 678 market stalls selling live animals and animal-related products.<sup>898</sup> The number of animals sold also appears to be low.<sup>899</sup> By contrast the market was a hive of human activity with an estimated 10,000 people shopping their daily.<sup>900</sup> Its crowded, densely packed and low ceiled stalls present the ideal congregate setting for a COVID-19 super spreading event.<sup>901</sup>

The positive environmental samples, including those taken on January 1 and 12, 2020, cluster in the southwest corner of the market, where animal vendors are believed to be located. This association is inconclusive, but the strongest available evidence links areas where SARS-CoV-2 virus was found with



the presence of animals. Unfortunately, no widespread serological surveys of Huanan Market workers have been published so it is unknown if animal vendors have SARS-CoV-2 antibodies or other indications of occupational exposure risk. In addition, very little to no information is available on whether SARS-CoV-2 was found in other Wuhan markets or the markets' supply chain.<sup>902</sup>

A recently published preprint study identified DNA from multiple susceptible intermediate host animals at the Huanan market. Genetic sequence data from environmental samples collected by the CDC between January 1 and February 2020 and published on the GISAID SARS-CoV-2 sequence repository on March 9, 2023 were analyzed.<sup>903,904</sup> Researchers identified near-complete mitochondrial-DNA sequences for 5 SARS coronavirus susceptible intermediate species including raccoon dogs, Malayan porcupines, Amur hedgehogs, masked palm civets and bamboo rats. In one particular SARS-CoV-2 positive environmental sample, the abundance of raccoon dog DNA exceeded that of human DNA.<sup>905</sup> This finding does not confirm whether the raccoon dog or any other animals themselves were infected with the virus. But establishing that the animals were at the market suggests that the pandemic could have had an animal origin.<sup>906</sup>

Based on this information and when the environmental samples were collected, the positive samples are unlikely to be evidence of the spillover occurring at the Huanan Market. The Huanan Market was closed on December 31, 2019, and sanitized.<sup>907</sup> Only 515 samples were collected on January 1, 2020.<sup>908</sup> It is unclear whether the market had already been sanitized when the January 1, 2020, sampling took place. For samples collected from January 12 to March 30, 2020, to be evidence of a spillover, the viruses would have had to survive on surfaces for 2 to 4 months and multiple rounds of disinfection. Based on experiments testing how long SARS-CoV-2 survives on surfaces, this is unlikely.<sup>909</sup> Moreover, all but one positive environmental sample were lineage B variants, a more human adapted strain of SARS-CoV-2 than lineage A.<sup>910</sup>

Evidence that the early outbreak was centered on the Huanan Market is mixed. The earliest requests for medical assistance on Weibo were concentrated approximately 6.5 miles from the Huanan Market on the opposite side of the Yangtze River in the Wuchang District.<sup>911</sup> Later requests for help track closely with population density and age.<sup>912</sup> By contrast, the spatial analysis in the Worobey study shows the Huanan Market was at the center of the early outbreak, but several scientists have questioned the authors' methods and conclusions.<sup>913</sup> In any event, the retrospective case identification investigation conducted by the PRC likely missed somewhere between 80% to 95% of all COVID-19 cases. Believing the early-December 2019 cases associated with the Huanan Seafood Market are among the first COVID-19 cases ignores the multiple reports of cases in November, 2019 as well as confirmed cases in early-December with no link to the market. Taken together, this suggests that the early to mid-December 2019 COVID-19 cases associated with the Huanan Market are not the earliest COVID-19 cases.

The PRC's presentations to the WHO reported several positive environmental samples from warehouses that supplied the Huanan Market and one positive environmental sample from one other Wuhan area market.<sup>914</sup> Though the specific market where the positive sample was collected from was not disclosed, the two markets identified are 6.5 and 38 miles away from the Huanan Market.<sup>915</sup> This suggests that early cases may have been more widespread and distributed across multiple markets. Without information on results of COVID-19 testing on animals taken from the Huanan Market and a more

complete picture of early COVID-19 cases it is unlikely that scientists can definitively resolve whether the market was the “epicenter”, or a “victim” of the COVID-19 outbreak. However, the available evidence indicates it was more likely an early super spreader location.

**c. Is evidence that China began a COVID-19 vaccine development program no later than mid-November 2019 consistent with a zoonotic origin?**

This investigation found evidence that China began SARS-CoV-2 virus vaccine development no later than November 2019. To begin building a vaccine construct, developers had to have the full genomic sequence of SARS-CoV-2. The full genomic sequence of SARS-CoV-2 was not publicly released until January 11, 2020. Normally, a sample from an infected patient is used to generate the sequence. Alternatively, a sample from an infected animal could be used. Therefore, to begin vaccine development, the PRC had to have found a human or animal infected with SARS-CoV-2 prior to mid-November, 2019 in order to have time to decide to initiate a vaccine development program.

Given that the COVID-19 pandemic appears to have begun sometime between mid-October and early to mid-November, 2019, it is possible that China’s COVID-19 vaccine development program was launched in response to the natural zoonotic spillover of SARS-CoV-2. However, a number of assumptions have to be made for the vaccine development program to be consistent with zoonotic spillover.

First, this hypothetical assumes that the vaccine development program was started in November 2019 and not earlier. This assumption requires the vaccines to be developed along a timeline similar to, if not faster than, Operation Warp Speed rather than a traditional development process. It also assumes that vaccines under development did not encounter any delays or failures prior to entering pre-clinical trials or clinical trials in early 2020. Given that none of the four vaccines identified went into mass production that may not be appropriate assumption.

Second, this hypothetical assumes that the PRC’s infectious disease surveillance system successfully detected early SARS-CoV-2 circulation and that local officials in Wuhan quickly alerted national leadership. The PRC’s post-SARS reforms appear to have dramatically improved infectious disease surveillance. PRC public health authorities have the skill, experience, and resources to conduct timely and accurate outbreak investigations. The PRC’s National NIDRIS surveillance system is designed so that a single suspected case of a SARS-related illness results in an alert to local and national CDC. Thus, in theory China’s infectious disease surveillance system was well positioned to detect an outbreak of SARS-CoV-2.

As detailed in Chapter 3, the PRC’s response to SARS-CoV-2 had a number of early missteps and shortcomings. In many instances the shortcomings appear to be the result of the PRC government officials censoring and withholding critical information. It is unclear how much information about the early outbreak was censored or withheld between different levels of government. However, there is some evidence suggesting that local Wuhan officials tried to downplay the scope of the outbreak to PRC’s national leadership. A small number of Wuhan and Hubei officials were dismissed for failing to follow PRC central leadership directives regarding the pandemic.

Officially, the PRC's central leadership became aware of the SARS-CoV-2 outbreak around December 29, 2019 and dispatched a team of public health experts to Wuhan on December 30. For the PRC's COVID-19 vaccine development program to be in response to a natural zoonotic spillover, PRC central leadership had to know about the COVID-19 outbreak no later than early-November 2019. The timing of their potential awareness is contrary with the ODNI assessment indicating that "China's officials probably did not have foreknowledge that SARS-CoV-2 existed before WIV researchers isolated it after public recognition of the virus in the general population."<sup>916</sup>

During SARS, local government officials in southern China initially concealed the scope of the disease outbreak from central leadership. The PRC central government, once it became engaged on the response to SARS, in turn publicly downplayed the outbreak's severity and scale while taking some public health actions to contain the virus. Partial transparency with the international community only came approximately six months after the first known SARS case when continued transmission, including internationally, forced the government to implement lockdowns of major cities and other measures that made hiding the scale of the outbreak impossible.

A similar series of events may have happened with SARS-CoV-2's emergence. If SARS-CoV-2 spilled over into humans in mid-October to early-November 2019 the PRC's central government could have first become aware of COVID-19 cases by mid-November, 2019 when the number of cases, although small, became too great for the local authorities in Wuhan to conceal. China's infectious disease reporting system may have limited local officials' ability to conceal cases with SARS-related symptoms. The realization that they were facing a virus many times more transmissible than SARS may have spurred them to immediately launch a vaccine development program. The damage that SARS inflicted on China's economy, social stability, and international standing, coupled with an inclination for secrecy and control, would make it unlikely that the PRC government would publicly announce the COVID-19 outbreak until forced to by the continued spread of the virus, which occurred in late-December 2019.

**d. Are the internal WIV reports referencing previous accidents involving a "highly pathogenic microorganisms" and other biosafety problems consistent with a zoonotic origin?**

The internal reports, patents, academic articles, and procurements from 2019 indicate that the WIV had problems with biosecurity and biosafety. Particularly concerning is the November 12, 2019, report from the BSL-4 laboratory's communist party branch that states "highly pathogenic microorganisms" had previously escaped. However, many of the internal reports only generally reference biosafety or biosecurity problems without specifying a particular concern. For instance, an internal report of a July 8, 2019, meeting states that WIV management were told to "personally strengthen their awareness of unexpected risks, to prevent and control the risks of [the spread of infectious disease at all times."<sup>917</sup> There is no mention of SARS-related coronaviruses in this report. In fact, none of the WIV's reports, academic articles, or other documents identified during this investigation expressly mention the WIV's coronavirus research.

Importantly, several of the patents and procurements are not necessarily specific to a potential biocontainment failure involving a respiratory virus, like SARS-CoV-2. For example, the July 31, 2019, procurement notice seeking repairs to the WIV's wastewater system is unlikely to represent repairs taken

in response to the possible escape of SARS-CoV-2.<sup>918</sup> Other procurements have few details and could represent the routine replacement of equipment, such as the March 1, 2019 procurement seeking positive pressure air suits.<sup>919</sup>

While the WIV was interested in SARS-related coronaviruses that share many of the same traits as SARS-CoV-2, there is no direct evidence the WIV had SARS-CoV-2 or a close progenitor virus in its possession before the pandemic.<sup>920</sup> The WIV's removal of its viral database from the internet and continuing refusal to allow independent review of its library of virus samples is certainly suspicious, but is not dispositive evidence that they had SARS-CoV-2 or a close progenitor. The WIV's interest in SARS-related coronaviruses that use human ACE2 receptors for cellular entry was far from unique among coronavirus researchers as the discovery of the BANAL series of SARS-related viruses by non-WIV researchers shows.

Accidents at high-containment laboratories happen. One 2013 survey of scientists revealed 46% of the approximately 2,400 respondents reported sustaining an injury during laboratory work.<sup>921</sup> The most common injuries were a "laceration/cut/bite" and needle pricks.<sup>922</sup> Chemical inhalation was another common injury.<sup>923</sup> Despite the frequency of laboratory accidents, precedent suggests that it is exceedingly rare for a research-related incident to lead to a global pandemic. Other than the 1977 H1N1 influenza pandemic, which is believed to be the result of either a laboratory accident or a vaccine challenge trial, no research-related incident involving a potential pandemic pathogen has led to a pandemic.<sup>924</sup> Research-related incidents, including several involving SARS, have resulted in transient human-to-human transmission of the released pathogen, but not the kind of sustained human-to-human transmission that started the COVID-19 pandemic. In short, to date "no epidemic has been caused by the escape of a novel virus".<sup>925</sup>

## Part II.

### Overview

Part II of this reference document will examine the available evidence that SARS-CoV-2 emerged as the result of research-related incident at the Wuhan Institute of Virology or one of the several other research institutes conducting coronavirus research located in Wuhan. Part II consists of four chapters.

### Chapter 7: Precedent: Research-related Incidents & Laboratory-acquired infections

#### Introduction:

There are a large number and diverse ways research-related incidents can occur.<sup>926</sup> The central concern of such incidents is the risk of infection of researchers or others. Incidents that result in infections are classified as laboratory-acquired infections (LAI). Laboratory-acquired infections are a reality of infectious disease research. They are difficult to investigate and data on their occurrence is limited. Studies of research-related incidents show that it is virtually "impossible to gain an accurate count of the true number of exposures and resulting infections."<sup>927</sup> According to published research, the cause of over

80% of laboratory-acquired infections is never determined.<sup>928</sup> When it can be determined, only 18% of the infections were due to known accidents caused by carelessness or human error.<sup>929</sup>

There are activities that are riskier than others. Higher concentrations of infectious agents are found in research rather than in clinical laboratories in hospitals for example.<sup>930</sup> Research on highly infectious agents, such as the research the WIV and other Wuhan-based research institutes were conducting, increases the chance that an exposure results in an infection than clinical labs performing diagnostic tests. The risk of exposure to infectious agents, the possibility of laboratory-acquired infections, or other accidents that threaten researchers or the broader community is a function of safety training, safe work practices, properly functioning safety equipment and laboratory design. The common routes of exposure are ingestion, sharps injuries (needle-sticks, cuts, animal bites) and inhalation.<sup>931</sup> Because infectious aerosols are difficult to see or detect, infections caused by inhalation represent the most insidious risk.

The Biosafety in Microbiological and Biomedical Laboratories manual published by the U.S. Centers for Disease Control and Prevention (U.S. CDC) and National Institutes of Health (NIH) outlines these problems.<sup>932</sup>

Less obvious exposures such as the inhalation of infectious aerosols or direct contact of broken skin or mucous membranes with droplets containing an infectious microorganism or surfaces contaminated by droplets may explain the incident responsible for a number of L[aboratory]-A[cquired]-I[nfection]s. Manipulations of liquid suspensions of microorganisms may produce aerosols and droplets. Small-particle aerosols have respirable size particles that may contain one or several microorganisms. These small particles stay airborne and easily disperse throughout the laboratory. When inhaled, the human lung will retain these particles. Larger particle droplets rapidly fall out of the air, contaminating gloves, the immediate work area, and the mucous membranes of unprotected workers. A procedure's potential to release microorganisms into the air as aerosols and droplets is the most important operational risk factor that supports the need for containment equipment and facility safeguards.<sup>933</sup>

There are several factors that complicate obtaining this data. While there are mandatory reporting requirements for laboratory accidents with specific agents in the U.S., not all researchers report all accidents with the full range of agents in either the U.S. or globally. Many LAI are dismissed as coincidental, mild, or constitutional abnormalities making accurate assessments difficult.<sup>934</sup> The absence of active worker health surveillance may also lead to under-recognition. Fear of reprisal, embarrassment and the stigma also impact self-reporting.<sup>935</sup>

Due to the lack of information on the actual numbers of infections and the population at risk, it is difficult to determine the true number of LAI. Experience suggests, however, that the recognition and isolation of a new infectious agent is often followed by a report of a laboratory acquired infection caused by the new isolate.<sup>936</sup> Younger workers, those with less technical training and men experience more accidents than older workers, those with more training or women.<sup>937</sup> Exposure to an infectious aerosol is such a well understood mechanism that it is considered a reasonable assumption as the cause of

laboratory-acquired infections of unknown origin. As such, aerosols are considered “ubiquitous” in laboratory settings.<sup>938</sup> Increases in the number of reported infections is thought to be associated with improved worker health surveillance, lack of appropriate biosafety equipment, or researchers in early stages of identifying new or unknown pathogens who may not be using appropriate biosafety protection.<sup>939</sup>

## **1. Overview of High-Containment Laboratories and Biological Safety Standards**

### **a. History of High-Containment Laboratories**

The origins of modern high-containment laboratories and biosafety standards date to World War II and the U.S. Army’s Biological Warfare Laboratories’ efforts to better protect its researchers. At the time, biosafety conditions varied widely among laboratories and were based largely on the professional judgment and experience of an institute’s leadership. One study of laboratory-acquired infections identified over 4,000 LAI including 168 fatalities, between 1930 and 1970.<sup>940</sup> What became the Biosafety Level (BSL) rating system in the United States was the result of a series of informal conferences to share best practices between experts in the military and later civilian federal agencies who were then working in biological, chemical, and nuclear laboratories in the 1950s and 1960s. From the 1970s through 1980s, the NIH and CDC began a concerted effort to set guidelines and disseminate best practices for high-containment laboratories at public health agencies, universities, and other research institutes.

In 1976, the NIH issued the “Federal Guidelines for Recombinant DNA Research” which established four levels of physical containment for recombinant DNA experiments based on the relative risk of the experiment and the biological agent involved. In 1984, the CDC released the first edition of its *Biosafety in Microbiological and Biomedical Laboratories (BMBL)*, which provides information on “best practices for the safe conduct of work in biomedical and clinical laboratories from a biosafety perspective.”<sup>941</sup> Similar initiatives to standardize biosafety practices in high-containment laboratories also occurred during this time frame in the United Kingdom, Canada, Australia, Japan, and France. The WHO published the first edition of its *Laboratory Biosafety Manual* in 1983.

The 1980s to 1990s saw a global expansion in the number of high-containment laboratories, particularly BSL-3 facilities. For example, China’s first BSL-3 laboratory was built in the early 1980s. This expansion accelerated in the 2000s as the result of a renewed focus on combating outbreaks of infectious diseases such as SARS, Ebola, avian influenza, and West Nile Virus. In the U.S. there was also a renewed emphasis on countering the risk of biological terrorism following the attacks on September 11, 2001.

### **b. Primary and Secondary Biosafety Barriers**

Biosafety measures used in laboratories are designed to protect employees from exposure to infectious agents and to protect the public. Biosafety measures are divided into two categories: primary barriers and secondary barriers. Primary barriers are defined as physical containment measure(s) placed directly at the level of the hazard.<sup>942</sup> They range from personal protective equipment (PPE) such as disposable gloves, over-garments and respiratory protection to biological safety cabinets (BSC) and other

specialized containment equipment.<sup>943</sup> Secondary barriers are features of laboratory design and construction such as specialized ventilation, handwashing sinks, waste treatment and management, and personnel access and control.

### **i. Personal Protective Equipment**

Personal protective equipment (PPE) protects the researcher from injury from a variety of sources (e.g., physical, electrical, heat, noise, chemical) or potential exposure to biological and aerosol hazards. PPE includes gloves, coats, gowns, sealed protective suits, shoe covers, respirators, face shields, safety glasses or goggles. PPE is used in combination with other biosafety controls such as BSCs that protect the researcher from hazardous biological agents and toxins, animals, or materials being handled. In situations where a BSC cannot be used, PPE may become the primary barrier between personnel and the hazardous biological agents and toxins. Examples include fieldwork, resource-limited settings, certain animal studies, animal necropsy, and activities relating to operations, maintenance, service, or support of the laboratory facility.

Appropriate PPE is determined on the risks identified for each respective laboratory.

### **ii. Biological Safety Cabinets**

According to the CDC's *Biosafety in Microbiological and Biomedical Laboratories* biological safety cabinets "are the primary means of containment developed for working safely with infectious microorganisms."<sup>944</sup> Biological safety cabinets, primarily built from stainless steel, are ventilated enclosures that allow scientists in high-containment laboratories to work safely with pathogens. Biological safety cabinets "are designed to provide personnel protection (for you and those around you), product protection (for your samples or specimens), and environmental protection."<sup>945</sup> Protection is accomplished primarily through controlling air flow through the cabinet so that air potentially contaminated during work on a pathogen is circulated away from laboratory personnel and contained within the cabinet until it is purified using a high efficiency particulate air (HEPA) filter.

Biological safety cabinets are organized into three classes based on the level of containment required, which is itself based on the pathogen being researched and the nature of experiments. BSC Class I and II cabinets have open fronts. Class I BSCs only use HEPA filters on air exhausted from the cabinet, whereas Class II BSCs run both recycled and exhaust air through a HEPA filter. Class I BSCs are appropriate for BSL I and BSL II laboratories. Class II BSCs are appropriate for BSL-2 through BSL-4 laboratories when paired with the correct level of PPE and located within the containment zone of a laboratory.

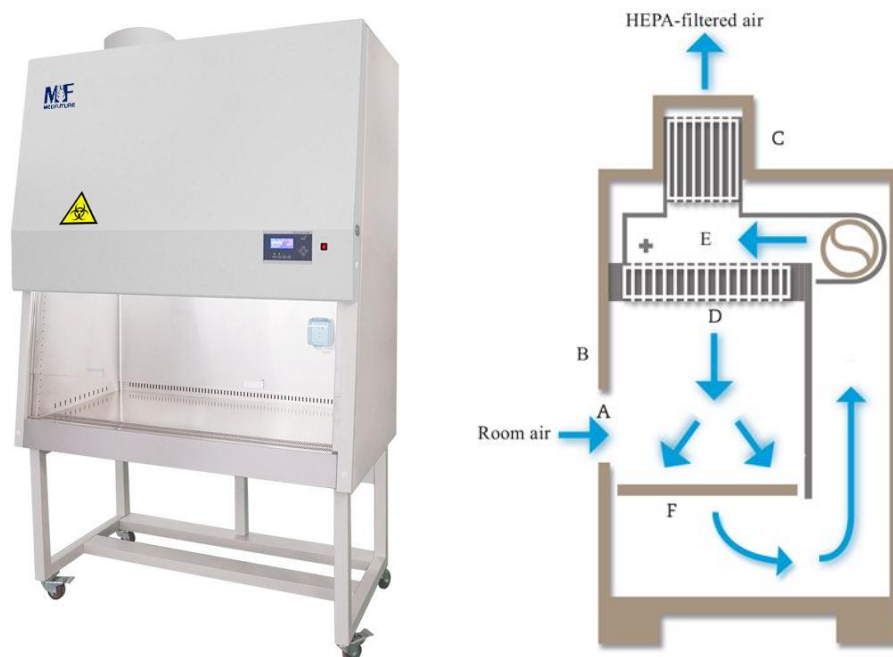

Figure 47. Graphic depiction Biosafety Cabinet and negative airflow with high-efficiency particulate (HEPA) filter  
Source: Biosafety Cabinets. <https://ehs.umass.edu/sites/default/files/Biosafety%20Cabinets.pdf>

Class I and II BSCs are only partial barrier systems and have work benches that are open to the laboratory. These BSCs rely on maintaining directional airflow for containment. Laboratory personnel using Class I and II BSCs must be properly trained to avoid inadvertently disrupting the direction of air flow which could cause a breach in containment. For example, activities that generate aerosols, such as centrifugation, should be conducted towards the back of the BSC away from the partially open front. Experimental work in a BSC should also be designed to go from clean to “dirty”.

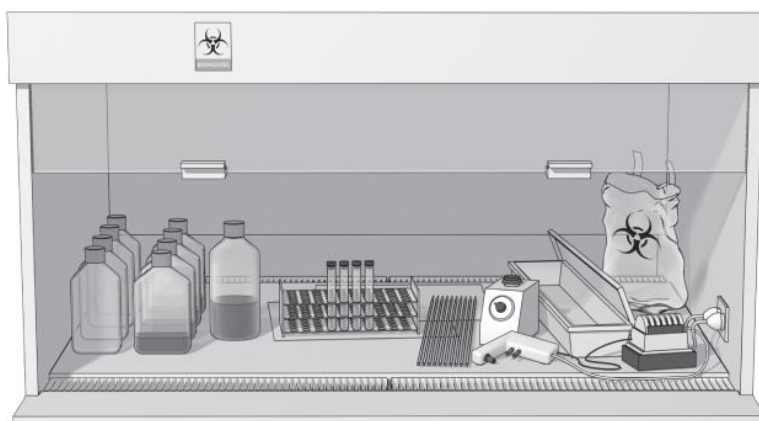

Figure 48. Graphic depiction of typical experimental biosafety cabinet with representative equipment including culture bottles, test tubes, bench top pipette, test tube mixer and hazardous waste disposal bag. Source: Biological Safety Cabinet Considerations. <https://labsafety.gwu.edu/biological-safety-cabinet-safety-considerations>

### iii. Secondary Barriers



Secondary barriers are features incorporated into the design and construction of the laboratory. Secondary barriers involve specialized ventilation, waste treatment management and personnel access control. The laboratory design is dependent on the type of agent and hazards anticipated. Therefore, a safety program is the result of a risk assessment based on an understanding of the pathogenicity of the agent, the susceptibility of the host, and, most importantly, the method of transmission of the infectious agent.<sup>946</sup> Once the risk is determined, the design, construction and biosafety equipment and practices address the cultivation, storage, and disposal of biohazardous materials; the facility operation; employee education; and medical surveillance of laboratory workers.<sup>947</sup> Risks are minimized through a variety of programs associated with the handling and disposal of infectious agents.

### **3. Overview of Biosafety Levels for High-Containment Laboratories**

The four biosafety levels (BSL) are BSL-1, BSL-2, BSL-3, and BSL-4, with BSL-4 being the highest (maximum) level of containment.<sup>948</sup> The four levels consist of combinations of safety equipment (PPE) and facility design features (primary and secondary barriers), facility practices and procedures. The appropriate combinations to safely conduct research are determined by a comprehensive facility-specific biosafety risk assessment that evaluates the properties of the biological agents and toxins to be studied, potential host characteristics, potential routes of infection, and the laboratory work practices and procedures conducted or anticipated to be used in the future.<sup>949</sup> While the WHO offers biosafety level guidance, no globally mandated standard exists. Biosafety levels generally differ depending on the risk of infection posed by a pathogen and the availability of preventive measures and effective treatments.<sup>950</sup>

#### **a. Biosafety Level 1 (BSL-1)**

Biosafety Level 1 (BSL-1) standard practices, safety equipment, and facility specifications are generally appropriate for undergraduate and secondary educational training and teaching laboratories and for other laboratories that work with biological agents not known to consistently cause disease in healthy adult humans.

#### **b. BSL-2**

Biosafety Level 2 (BSL-2) standard practices, safety equipment, and facility specifications are applicable to laboratories in which work is performed using a broad-spectrum of biological agents and toxins that are “moderate-risk agents,” associated with causing disease in humans of varying severity. Workers in BSL-2 laboratories should have “specific training in handling pathogenic agents and are supervised by scientists competent in handling infectious agents and associated procedures.”<sup>951</sup> With good practices and procedures, these agents and toxins can generally be handled safely without employing a biosafety cabinet (BSC) provided the potential for producing splashes and aerosols is low.<sup>952</sup>

Biological agents and toxins routinely handled at BSL-2 should not be transmissible by the aerosol route. Procedures performed in BSL-2 settings that could result in aerosol or high splash potential are conducted within primary containment equipment, such as a BSC or safety centrifuge cups. The use of primary containment equipment such as BSC and PPE is also recommended when high-risk infectious

agents are suspected to be present in any human, animal, or plant-derived specimens.<sup>953</sup> BSL-2 laboratories are generally not required to maintain a negative pressure gradient relative to areas outside of the laboratory. However, the laboratory should be designed so that potentially contaminated air flows do not recirculate to areas outside of the laboratory and BSCs should be placed away from doors to limit the risk of a disruption in airflow.

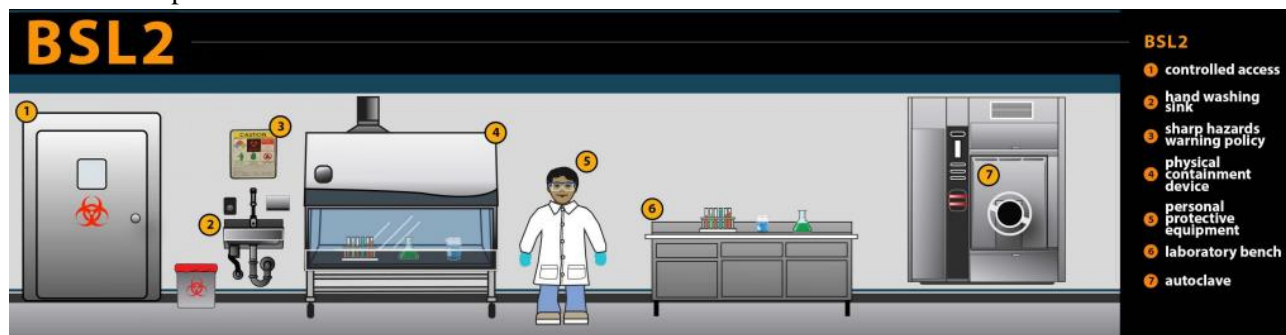

Figure 49. Biosafety Level 2 (BSL-2) Infographic. Source: Centers for Disease Control and Prevention. [4 Biosafety Levels \(cdc.gov\)](#)

### c. BSL-3 and ABSL-3:

Biosafety Level 3 (BSL-3) standard practices, safety equipment, and facility specifications are applicable to laboratories in which work is performed on biological agents “that may cause serious or potentially lethal disease through the inhalation route”.<sup>954</sup> Thus, one of the key differences from BSL-2 and BSL-3 work is the risk of exposure via respiratory transmission and the risk that the pathogen may cause serious and potentially lethal infection.

The use of animals in such settings introduces further risks that must be anticipated and mitigated. Animals infected with a zoonotic agent may generate aerosols, may bite and scratch. The application of the Animal Biosafety Levels (ABSL) is determined by protocol-driven risk assessments to determine the required biosafety level and practices.

SARS-related viruses, tuberculosis, and bacteria with known aerosol hazards such as *Coxiella burnetii* are examples of the biological agents that should be handled in BSL-3 because they can be transmitted by aerosols and cause serious illness. The primary routes of exposure to personnel working with these types of biological agents and toxins relate to accidental exposure via inhalation of potentially infectious aerosols as well as through percutaneous or mucosal routes.

At BSL-3, more emphasis is placed on primary and secondary biosafety barriers to protect personnel, the surrounding community, and the environment from exposure to potentially infectious aerosols. All procedures involving the manipulation of infectious materials are conducted within a BSC. Secondary barriers for BSL-3 laboratories include enhanced ventilation systems, negative pressure airflow and exhaust HEPA filtration. Laboratory access is controlled limit access to only laboratory approved personnel, and may contain additional design features such as anterooms, airlocks, exit showers.

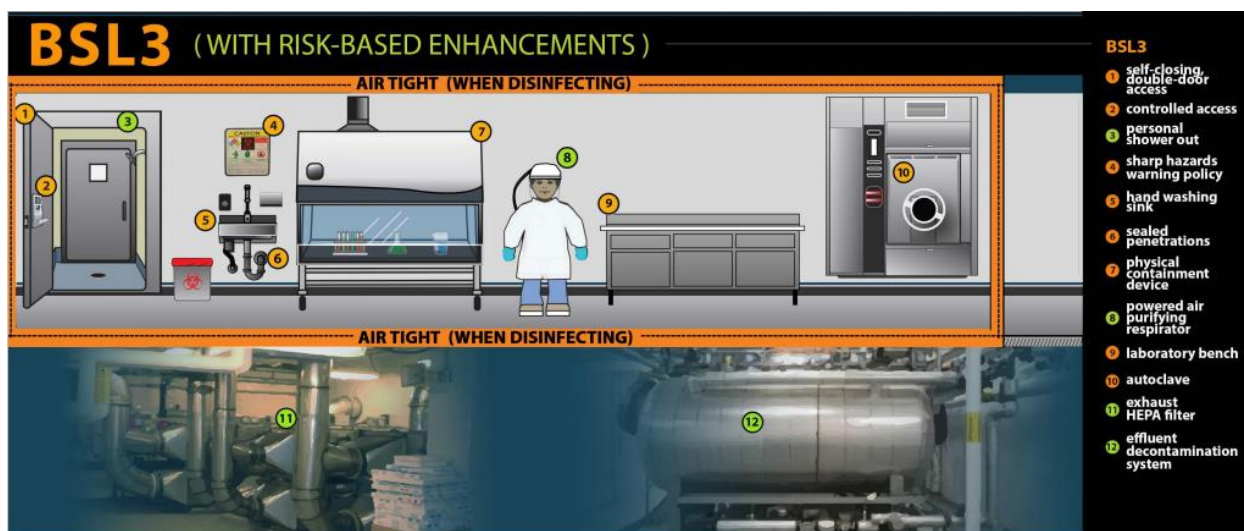

Figure 50. Biosafety Level 3 (BSL-3) Infographic. Source: Centers for Disease Control and Prevention. [4 Biosafety Levels \(cdc.gov\)](#)

#### d. BSL-4

Biological agents that pose a high individual risk of life-threatening disease by infectious aerosols and for which no treatment is available are limited to the highest containment facilities that meet Biosafety Level 4 (BSL-4) standards. Ebola virus, Marburg virus and Congo-Crimean hemorrhagic fever virus are examples of the infectious agents that meet these criteria.

The laboratory worker's complete isolation from aerosolized infectious materials is accomplished primarily by working in a Class III BSC or in a Class II BSC with a full-body, air-supplied positive-pressure personnel suit.

Unlike BSL-3 or lower laboratories, BSL-4 laboratories require more complex safeguards that require significant expertise to design and operate. BSL-4 laboratories are hermetically sealed and subject to constant directional negative air flow that filters exhaust gases through at least two serial HEPA filters before release into the atmosphere.

Aerosol studies using simulants evaluated the risk of LAIs considering the need to perform experimental studies with SARS-CoV-2. As described, "[a] BSL-3 laboratory is mandatory for testing pathogenic bioaerosols and for vaccine development, such as for COVID-19, that display high infectivity. However, such biosafety laboratories could become a source of LAIs if they are inappropriately designed and operated."<sup>955</sup> Researchers demonstrated that walls and equipment in BSL-3 laboratories conducting aerosol generating experiments could be a source of contamination and require careful disinfection. Bioaerosols suspended in such laboratories may last several minutes requiring delays in performing experimental steps to permit removal of such infectious aerosols by exhaust ventilation.

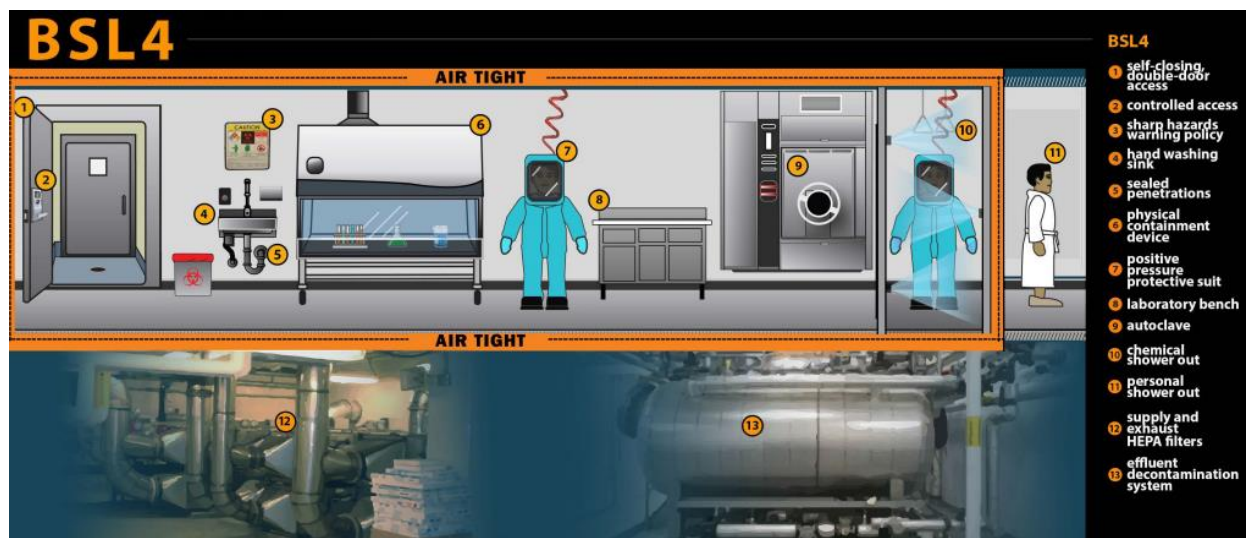

Figure 51. Biosafety Level 4 (BSL-4) Infographic. Source: Centers for Disease Control and Prevention. [4 Biosafety Levels \(cdc.gov\)](https://www.cdc.gov/4biosafety/)

Scientists and government officials in China are well aware of the many dangers associated with highly infectious pathogens like bat-related coronaviruses. As recognized by researchers from the People's Liberation Army Academy of Military Medical Sciences in February 2020, infection through aerosols is the most common avenue of infection for researchers. Further, they also recognized research-related activities like sample collection as a risky part of the experimental process. The authors wrote:

The experimental activities in the biosafety laboratory mainly involve sample collection, transportation, receiving, processing, experimental operation and preservation, waste disposal, etc. For each activity, there is a risk that if control methods are improper, pathogens can infect the experimental staff or spread outside the laboratory to infect people in society. The reasons for biosafety laboratory infections mainly include cuts, punctures, direct exposure of skin, mucosa, and eyes directly exposed to infectious microorganisms, animal bites, inhalation of infectious aerosols, etc. Among them, aerosol infection is the most common, because aerosols are ubiquitous during experiments and are difficult to detect...<sup>956</sup>

Studies have shown that there are risks of aerosol exposure in variety of experimental operations, including high concentration of suction and mixing, ultrasonic lysis, accidental dropping of high-concentration culture bottles, rupture of centrifuge tubes, accidental spillage of freeze-dried powder, accidental squirting [spraying] when injecting an animal, and animal dissection, etc. Of these, the accidental squirting [spraying] of the challenged animal produces the highest aerosol concentration.<sup>957</sup>

#### 4. Challenges Associated with Proliferation of High-Containment Laboratories in Middle Income and Developing Countries

Biosafety experts have identified a number of challenges associated with operating high-containment laboratories in developing and middle-income countries. Many of the countries building new BSL-3 and, to a lesser extent, BSL-4 laboratories do not have decades of institutional experience in managing such facilities. Biosecurity efforts have identified a number of concerns regarding the safe operation of these laboratories, such as a lack funds to sustain operations and maintain biosafety equipment or ensuring that laboratory employees and scientists have adequate training in proper techniques.

The National Academies of Sciences has held at least two large international workshops on the issue, one in 2011 and one more recently in 2018. The 2011 workshop “examined biosafety and biosecurity issues related to the design, construction, maintenance, and operation” of BSL-3 and BSL-4 laboratories. One of the workshops’ presenters from Southeast Asia summarized the challenges for high-containment laboratories in the region compared to those in countries with more experience operating such facilities:

[D]eveloped countries had a head start on biosafety and biosecurity and have led with regulations, standards, and guidelines that call for complex, technology intensive facilities. Hallmarks of high-containment facility designs in developed countries include double door entries, directional airflow, negative pressure gradients, single pass air, many air changes per hour, autoclaves, 24/7 operation, and multiple safety redundancies....

[M]any developing countries [need] . . . a greater focus on the fundamentals of biosafety because many of their facilities for handling infectious agents were built more than 10 or 20 years ago and incorporate limited biosafety measures. A recent survey ... of BSL-2 and BSL-3 labs in seven countries in the Asia-Pacific region, for example, indicated that many labs are below an acceptable level of functionality for their BSL level. The survey noted that often HEPA filters lack the dampers necessary for maintenance, biological safety cabinets are uncertified and usually powered off, and unreliable electrical power is not backed up with generators. Overall, about 30% of the Class II [biological safety cabinets] tested were poorly designed or dysfunctional and failed, and many BSL-3 facilities were either designed incorrectly or operated incorrectly.<sup>958</sup>

The workshop also noted that consistent, adequate funding for laboratory operations was a problem for facilities located in middle income and developing countries and should be considered when planning laboratory operations:

[T]he best solutions typically understand and account for cost pressures, the lack of local technical equipment and replacement parts, unreliable utilities, and local inexperience in constructing and operating complex BSL-3 facilities... BSL-3 containment space is very expensive to build, operate, and maintain, and working at the BSL-3 level is less efficient (e.g., protective clothing, entry/exit procedures, and medical surveillance) than working at lower containment levels . . . overdesign and unnecessary use of BSL-3 labs should be avoided.<sup>959</sup>

With respect to Southeast Asia, one presenting expert, Dr. Stuart Blacksell of the Mahidol Oxford Tropical Medicine Research Unit (MORU), summarized efforts to ensure safe operations of BSL-3 laboratories through engagement, training, and support arrangements:

Dr. Blacksell started by noting that the world's population is concentrated in Southeast Asia and that newly emerging diseases (e.g., severe acute respiratory syndrome [SARS] and f), agents of increased virulence (e.g., avian influenza and tuberculosis), and endemic diseases caused by risk group 3 agents drive the region's diagnostic and research needs. While Southeast Asia has at least 45 BSL-3 labs, Dr. Blacksell explained that running a facility responsibly requires a huge investment of time, people, facilities, and money, and questions exist about standards, management, training, and security for most labs in the region....

Historically, the area has lacked a safety culture, so MORU requires a robust induction procedure and documents all training and the resulting competencies of its employees. For its training, MORU utilizes consultants, the United States Department of State Biosecurity Engagement Program (BEP), Sandia National Laboratories, the World Health Organization (WHO), and the Australian Government Overseas Aid Program (AusAID). Training includes dual-use awareness, and labs hold regular refresher training...

Other challenges include mismanagement, finding local services and resources, and limited budgets, particularly for maintenance and training....

Given the complexity of running BSL-3 labs in the area, Dr. Blacksell encouraged people considering new labs to accurately assess their initial expenses, anticipated operational and maintenance costs, and the associated biosafety and biosecurity risks to determine if a BSL-3 is truly needed or if a BSL-2 with BSL-3 practices might be sufficient to meet their needs.<sup>960</sup>

The 2018 workshop echoed many of the same concerns lodged during the 2011 conference. Specifically, the need for funding entities (NGOs, governments of developed countries, and international agencies) and host countries to carefully plan both the construction and operation of high-containment laboratories so that work can be sustained and conducted safely. Of potential relevance to this investigation, the consensus views of workshop participants noted that:

- Biological containment laboratories pose some safety and security risks. Context matters when assessing risk. Participants suggested several contextual factors: the lab's purpose (routine clinical diagnostics, disease surveillance, maintenance of reference samples, research, outbreak response); the degree of hazard of the pathogens being handled; whether those pathogens are endemic (containment requirements may differ if the pathogen is already present in the local environment); lab personnel adherence to safety and security protocols; the regularity and effectiveness of inspections; and the adequacy and reliability of funding, electricity, water, waste treatment, transportation, supply chains, and internet and

telecommunications. For a partnership to be successful, the stakeholders must work together before the project starts to align the purpose of the planned laboratory with the needs and capabilities of the host or recipient.

- A capable workforce and a strong training program are essential to the proper functioning of a biological laboratory. Many participants suggested that funders should address knowledge gaps in regions with inadequate educational systems and should arrange for provision of training by local sources (preferable, if possible), third parties (professional societies, biosafety organizations, and private companies), or their own personnel (if a technical organization). They also stressed the importance of leadership skills, career planning, and promotion opportunities to retain workers. Funders could also engage with local or foreign universities to provide the appropriate education and training.
- Biosecurity has not received proper attention in low-resource countries. It is, nevertheless, just as crucial an element in the operation and maintenance of biological labs as is biosafety. Funders should ensure that recipients recognize the importance of biosecurity and biosafety and have plans to adopt and implement all required measures.<sup>961</sup>

## 2. Precedent of Outbreaks Likely Caused by Lab Accidents

The prevalence of laboratory accidents and laboratory-acquired infections is an area of active debate. Competing academic articles have come to vastly different assessments and tend to reflect their authors' views on the relative risk benefit of conducting gain of function research on potential pandemic pathogens. One group of prominent researchers, when arguing for a moratorium on gain of function experiments involving potential pandemic pathogens, calculated that “work with a novel, transmissible form of influenza virus carries a risk of between 0.01% and 0.1% per laboratory-year of creating a pandemic.”<sup>962</sup> They cautioned that these calculations may understate the risk because, amongst other variables, “the rate of accidents is calculated for U.S. labs, while gain of function (GOF) experiments are performed in many countries; if this work expands to some of the many countries with less stringent standards than those in the [U.S.], risks could be higher.”<sup>963</sup>

In response, an article by Dr. Ron Fouchier, a proponent of GOF experiments involving potential pandemic pathogens, concluded that the risk of a laboratory accident causing a pandemic is much lower, “the risk of [laboratory-acquired infections] associated with work on viral pathogens [is] estimated as less than 1 per 2,044 laboratory-year.”<sup>964</sup> In support of this conclusion, the article draws heavily from the safety precautions taken by Fouchier and his team when conducting an experiment that successfully transmitted the 1918 pandemic influenza virus via respiratory droplets or aerosols between ferrets:

In ordinary BSL-3 laboratories, including diagnostic laboratories, work is performed in open-front class 2 biosafety cabinets with directional airflow, aimed at protecting the environment from release of pathogens and protecting laboratory workers from exposure. Contrary to ordinary BSL-3 conditions for work with viruses, all *in vivo* and *in*

*vitro* experimental work on influenza virus transmission in the Erasmus MC facility is carried out in class 3 isolators or class 3 biosafety cabinets, which are airtight boxes with negative pressure ( $<-200$  Pa), to ensure inward flow in case of leakage. Handling is done through airtight gloves fitted to the front of these cabinets. Air released from the class 3 units is filtered by high efficiency particulate air (HEPA) filters and then leaves directly via the facility ventilation system, again via HEPA filters. Only authorized and experienced personnel that have received extensive training can access the facility. For animal handling, personnel always work in pairs to reduce the chance of human error. Although the laboratory is considered “clean” because all experiments are conducted in closed class 3 cabinets and isolators, special personal protective equipment, including laboratory suits, gloves, and FFP3 (class 3 filtering face piece) facemasks, are used, and all personnel are vaccinated with the homologous A/H5N1 vaccine. All equipment in the facilities is monitored electronically, and alarm systems are employed to ensure that workers do not enter the facilities if equipment is malfunctioning. All personnel have been instructed and trained how to act in case of incidents, which are handled upon consultation between a senior staff member, a clinical microbiologist, the institutional biosafety officers, and the facility management. Antiviral drugs (oseltamivir or zanamivir) are used immediately if an incident should occur. Every incident in the laboratory is followed up by actions to prevent such incidents from happening again. The facilities, personnel, and procedures are inspected by the U.S. CDC every 3 years, in agreement with the U.S. select agent regulations for overseas laboratories and by the Dutch government (Inspectie Leefomgeving en Transport [ILT] inspection)

The biosafety conditions in the Erasmus MC facility thus extend well beyond “normal” BSL-3 conditions for working with viruses, and a number of these biosafety measures should be considered when the probability of LAIs is inferred from the U.S. CDC report. Unfortunately, an exact number for the effectiveness of individual biosafety measures is not available. However, it is reasonable to assume that the effectiveness of the physical separation of personnel from the viruses they work with through the use of class 3 isolator units and class 3 biosafety cabinets, the use of personnel protective equipment, the extensive training program, the use of experienced personnel only, and the application of a two-person rule to reduce human error during animal experiments would yield a decrease in the probability of LAIs.<sup>965</sup>

Undertaking such extensive biosafety precautions does likely increase the margin of safety for an experiment such as the one Fouchier performed.<sup>966</sup> However, as Fouchier noted, the biosafety conditions were “well beyond ‘normal’ BSL-3 conditions.”<sup>967</sup>

Canadian biosafety researchers reviewed data on laboratory incidents involving biological agents that were reported to Public Health Canada from January 1 to December 31, 2016.<sup>968</sup> The review found an overall incidence rate of 3.4% with 46 “exposure incidents” reported by 835 licensed entities. “A total of 100 people were exposed, with no reports of secondary exposure. Four incidents led to suspected or confirmed cases of laboratory-acquired infections.”<sup>969</sup> Over 91% of accidents occurred in BSL-2 facilities.



Such comprehensive reporting is rare. Available documentation of historical lab accidents is incomplete, but what is available suggests that a number of infectious disease outbreaks caused by laboratory accidents have occurred in the last fifty years. Available evidence, including documentation from the Federal Select Agent Program (FSAP), also suggests that a large number of laboratories acquired infections (LAI), including subclinical infection, and hundreds of “possible release” events have occurred in the U.S. and elsewhere.

Biosafety experts have identified several factors that determine the risk that pathogen exposure may lead to infection:

- The amount of infectious dose required for transmission;
- Whether the pathogen has low or high communicability;
- Whether the pathogen is aerosolized or transmissible via airborne spread;
- History of past laboratory infections involving the pathogen; and
- Whether humans or experimental animals are susceptible to the pathogen.

Likewise, specific laboratory procedures and experiments present an increased risk of exposure:

- Producing and using large volumes and high titers of a pathogen;
- Following procedures that might generate aerosols;
- Infecting animals;
- Using sharps (needles, etc.);
- Necropsy of infected animals; and
- Experiments that increase virulence of a pathogen.

The 2018 National Academies conference presenters noted that high-containment laboratories are “only as good as its least-trained worker, and human factors are generally the cause of laboratory-acquired infections rather than malfunction of engineering controls.”<sup>970</sup> The available evidence on laboratory accidents suggests that the “least-trained workers” are often graduate students or post-doctorate students working in BSL-2 and BSL-3 facilities.

Laboratory accidents that resulted in exposure to a pathogen, but no known infections, “near misses”, provide an additional body of evidence as to the kind of accidents that can occur in high-containment laboratories. In many instances, it appears that only random chance or good luck prevented an accidental exposure from resulting in an infection. Thus, even infections that did not lead to subsequent spread can inform an assessment of the likelihood and scenarios of a lab origin through human error for COVID-19 and future pandemics. Thus, the historical record serves as context in the discussion of the origins of SARS-CoV-2 resulting from research acquired infection.

#### **a. Near-Misses, Laboratory Accidents Not Resulting in Infections**

##### **i. Graduate Student Accidents**

Behavioral factors figure prominently in the incidence of documented laboratory accidents. An estimated 65 to 80% of documented laboratory accidents are due to human error.<sup>971</sup> In published laboratory safety studies, research students were involved more frequently than any other single group. It was noted that students performing research in infectious laboratories are, as a group, less familiar with laboratory techniques and procedures than experienced scientists and technicians. Students were more often performing new or untried techniques, and often worked longer hours than other laboratory personnel.<sup>972</sup>

In September 2016, a Washington University graduate student working by herself in a BSL-3 laboratory on a weekend inoculated mice with Chikungunya virus. Despite wearing two sets of gloves and appropriate PPE, she accidentally pricked herself with a needle she was using to inject infected mice. The student appropriately disinfected the wound but did not inform anyone. Four days later she became ill and presented herself at the University's emergency room where she tested positive for Chikungunya. Only after she became ill did she inform her supervisor.<sup>973</sup>

Her illness did not result in the infection of anyone else. Because of her accident, the laboratory instituted remedial training about the risk of accidental needle-sticks. In the following 14 months, however, Washington University reported two additional incidents involving needle-sticks with the Chikungunya virus. As characterized by Dr. Richard Ebright, a Rutgers University molecular biologist: "People have it in their minds that lab accidents are very, very rare, and if they happen, they happen only in the least well-run overseas labs. That simply isn't true."<sup>974</sup>

In 2020, a graduate student at Tufts University spilled a test tube containing H3N2 flu virus, a mild seasonal flu virus. However, due to the COVID-19 pandemic, neither the graduate student nor other laboratory personnel who assisted with the clean-up were wearing respirators or masks. Tufts had been unable to purchase PPE due to pandemic demand, despite express policies requiring laboratory personnel to wear them during experiments. Fortunately, none of the exposed were infected.

## **ii. Escape of Infected Lab Animals**

Laboratory animals used in experiments present a distinct category of laboratory accidents. Live animals are frequently used, sometimes in large numbers, and can escape enclosures within labs, as well as escape entire facilities. Because some of these animals are often infected with a pathogen under research, the escape of a lab animal can mean the escape of a pathogen.

In December 2006 at Texas A&M University, in College Station, TX, a laboratory mouse infected with *Coxiella burnetii* (Q Fever) went missing. The mouse was never found.<sup>975</sup> Similarly, between April 2013 and September 2014, eight mice, some of which may have been infected with SARS-CoV-1 or H1N1 influenza virus, escaped from a laboratory at the University of North Carolina at Chapel Hill.<sup>976</sup> No humans were effected and no viral transmission has been documented from either case.

## **iii. Mechanical Failures**

An essential element of high-containment laboratory biosafety is the effectiveness of secondary barriers. Maintaining negative pressure, HEPA filtration and effective disposal of infectious waste protects not only researchers but others working in the facility and the public. The effectiveness of these barriers is dependent on maintaining the proper functioning of the associated mechanical equipment. Failure of anyone of these components could result in unintended risks and exposures.

In 2010, an autoclave used to decontaminate laboratory waste in a BSL-3 laboratory at the University of California, Irvine malfunctioned. An autoclave creates high temperature and pressure to inactivate infectious materials. While decontaminating waste from SARS virus experiments, the autoclave leaked steam and water, potentially exposing eight people. Fortunately, the autoclave reached a high enough temperature to kill the SARS virus before malfunctioning.<sup>977</sup> As described, the “[r]eleased materials were contained in our BSL-3 laboratory. Exposed lab workers were wearing proper personal protective gear. No transmission of the virus was detected.”<sup>978</sup>

Laboratory accidents and associated infections are often the result of an unfortunate chain of events. As described by biosafety consultant Dr. Rocco Casagrande, they often result from “cascading errors.” “Some physical mistake happens that then takes advantage of vulnerabilities introduced by someone’s carelessness or mental mistake or happenstance. Someone spilled something when the backup fan happens to be knocked out by a power outage, or someone spilled something on the day that their lab coat was at the cleaner.”<sup>979</sup>

## **b. Laboratory Accidents Resulting in Infections**

### **i. SARS-CoV-2 Laboratory Accidents**

This investigation has identified three laboratory accidents involving SARS-CoV-2 since the pandemic began. There have been other laboratory accidents that have gone unnoticed (because normal community spread of SARS-CoV-2 has been high) or they have not been reported. The investigation was only able to find substantial information about one of the three incidents. None of the following laboratory incidents involving SARS-CoV-2 appears to have led to secondary cases of COVID-19.

There is at least one documented laboratory escape of SARS-CoV-2 in China. In February 2020, early in the pandemic, the director at the National Institute for Viral Disease Control and Prevention (NIVDC) was infected with SARS-CoV-2 in the laboratory. The accident only came to light when a former NIVDC researcher, Shan-Lu Liu, a virologist now affiliated with the Ohio State University and the editor of the Chinese journal *Emerging Microbes & Infections* described it. In a February 14, 2020 email exchange among colleagues obtained through an Ohio Public Records Act request, Liu shared that his former NIVDC director “has now been infected with SARS-CoV-2.”<sup>980</sup> He later clarified that the former director was in fact “infected in the lab”, and that “I am actually very concerned for the possibility of SARS-2 [sic] infection by lab people. It is much more contagious than SARS-1.”<sup>981</sup> Chinese state media has denied that an infection occurred.<sup>982</sup> The Beijing NIVDC is the same laboratory where a researcher became infected with SARS in the laboratory in 2004 – one of four such known cases in China and six in the world.

In December 2021, a researcher in Taipei at Academia Sinica Genomics Research Center, a laboratory of Taiwan's national academy, was exposed to SARS-CoV-2 during research using infected mice in a BSL-3 facility. The researcher became ill and tested positive for a Delta variant of SARS-CoV-2, with PCR Ct values of 15 and 23, indicating a recent infection.<sup>983</sup> As a laboratory acquired infection confirmed by Taiwanese authorities, the case and the identified breaches in safety inform an understanding about the general propensity of SARS-CoV-2 to escape laboratory settings.

The genomic sequence recovered from the researcher did not match any that of any domestic cases in Taiwan collected during the relevant period. This, and the lack of any overseas travel or contact by the researcher with confirmed cases, led the CECC to conclude she did not become infected by local community spread. This case was the first domestic case of COVID-19 in Taipei in 35 days.<sup>984</sup>

The same researcher was bitten by a laboratory mouse on October 15, 2021, but later tested negative for SARS-CoV-2. The researcher was again bitten by a mouse on November 19, 2021, but did not get tested. An investigation into the incident suggested the researcher was infected by other improper doffing of her PPE and decontamination upon leaving the laboratory rather than from the mouse bite. The results of the investigation were published.<sup>985,986</sup>

## **ii. Brucella Accident in Lanzhou, China**

In late 2019, an accidental release of *Brucella* from a lab in Lanzhou, China, infected between 6,000 and 10,000 people.<sup>987</sup> Brucellosis cases were individuals who were present at the Lanzhou Veterinary Institute, which is downwind from the Zhongmu Lanzhou biological pharmaceutical factory. The factory had been growing *brucella* as part of work to create animal brucellosis vaccines for livestock. Routine cleaning at the facility was inadequate – using expired disinfectants – which allowed live brucella bacteria to become aerosolized in waste gas emitted in the facility's exhaust ventilation system.<sup>988,989</sup> This was the second brucella breach of facility containment in China in 3 years. A review of Chinese medical databases conducted in early 2020 reveals additional laboratory acquired cases of brucellosis in 2006, 2007, 2011, 2012, 2013, 2016, and 2017.<sup>990</sup>

## **iii. Foot and Mouth Disease Virus**

In the United Kingdom (UK), an outbreak of foot and mouth disease in 2007 was the result of the escape of live foot and mouth disease virus (FMDV) from the Pirbright Institute, a United Kingdom government laboratory researching animal pathogens in Surrey. A manufacturer co-located at the site was producing substantial quantities of FMDV for use in the production of FMDV vaccine and was using the Pirbright Institute's drainage system. Failures in decontamination of effluents from the facility, combined with apparent leakage from a drainage pipe damaged by tree roots, allowed live FMDV to escape the facility. Use of construction equipment in the surrounding areas exacerbated the spread of contaminated soil, leading eventually to the infection of nearby cattle.<sup>991</sup>

The outbreak of FMDV was contained through quarantine of an affected area and the culling of all susceptible species within a set vicinity of the Institute. The 2007 outbreak involved eight farms and

the culling of over 2,000 head of livestock, costing the government of the UK GB£47 million and industry GB£100 million, or about US\$300 million.<sup>992</sup>

#### iv. SARS

The Severe Acute Respiratory Syndrome Coronavirus (SARS-CoV-1 or SARS) first emerged in China in 2002, eventually leading to at least 8,000 infections and 774 deaths. Since the end of the SARS pandemic in 2003, SARS has not naturally recurred. It has, however, re-entered the human population no less than 6 times because of laboratory accidents. These accidents took place once at the Environmental Health Institute of Singapore<sup>993</sup>, once at the National Defense University in Taipei, Taiwan, and four times at the National Institute of Virology (NIV) in Beijing.<sup>994</sup>

The first laboratory escape of SARS-CoV-1 was in Singapore, in August 2003. It involved a 27-year-old doctoral student working with both SARS-CoV-1 and West Nile virus (WNV). Due to renovations of the normal BSL-2 lab at this facility, BSL-2 and BSL-3 activities were being conducted in the same BSL-3 lab, leading to the laboratory accident. SARS-CoV-1 virus was present in the lab two days prior to the infection of the graduate student, who contracted SARS because the Vero E6 cells he was using to passage WNV were previously contaminated with live SARS-CoV-1.<sup>995</sup> The student was hospitalized on September 3, 2003 and recovered after a period of moderately severe disease, and did not infect anyone else.

In Taiwan, on December 6, 2003, a researcher working on SARS-CoV-1 was cleaning up leaked waste fluid from an experiment, but was infected by SARS-CoV-1, which had escaped the primary biocontainment area and was present on a bottle of cleaning spray and a light switch. The patient then attended a SARS summit in Singapore on December 7, 2003 fell ill on December 10, 2003, was hospitalized on December 16, and ultimately recovered without causing secondary infections.<sup>996</sup>

At China's National Institute of Virology (NIV) in Beijing, there were two separate laboratory-acquired infections of SARS-CoV-1 in February and April 2004, each involving a different researcher. A subsequent investigation looking for specific antibodies among other NIV lab staff found 2 additional SARS-CoV-1 cases, bringing the total of separately infected NIV staff to 4. There was a month between the date of infection of the index case and the (public) identification of the index case. Of the first 2 identified cases, one led to the death of the worker's mother, and six other individuals were infected by the workers but did not die.<sup>997</sup>

Laboratory accidents are not always reported in a timely manner. Even when infections are clearly laboratory acquired, and when the laboratory where an infection was acquired is identified, the exact accident that caused the infection cannot always be identified. In the known laboratory acquired cases of SARS-CoV-1 in 2003 and 2004, infected individuals traveled, waited days to report symptoms even after becoming sick shortly after conducting SARS experiments, and in some cases infected others.

When the Taiwanese researcher was infected in December 2003, he did not seek medical attention for fear of bringing "shame to his lab and the country".<sup>998</sup> It was only when his father threatened

to kill himself if the researcher did not seek medical attention that he called an ambulance and reported his case, which had become a clear and severe case of SARS.

The accidental laboratory release of a highly contagious respiratory pathogen like SARS-CoV-1, released six times by laboratories, further demonstrates the possibility of laboratory escape of pathogens. SARS-CoV-1, notably, is not as contagious as SARS-CoV-2.

#### **v. 1977 H1N1 Influenza Pandemic**

Influenza A viruses are the only influenza viruses known to cause pandemics in humans, although influenza B viruses also infect humans and seals. Influenza viruses are classified based on two proteins on the surface of the virus capsid (the outer layer of proteins of the virus): hemagglutinin (H) and neuraminidase (N). There are 18 different hemagglutinin subtypes and 11 different neuraminidase subtypes: H1 through H18 and N1 through N11, respectively.

The emergence of any new virus or new strains of a virus is often accompanied by the disappearance of preexisting seasonal virus strains. To illustrate, a variant of influenza known as H1N1, which first emerged with the 1918 influenza pandemic, was the dominant circulating strain of influenza in the world for 39 years from 1918 to 1957, at which point it was replaced by an H2N2 virus. This H2N2 virus was the dominant strain of influenza circulating globally for 11 years, when it was replaced in 1968 by an H3N2 virus. From 1957 to 1977, no H1N1 influenza virus was isolated from new cases. In 1977, an H1N1 virus resembling the 1950 H1N1 strain reemerged and, instead of replacing the H3N2 virus, co-circulated with H3N2 influenza until 2009. In 2009, a novel H1N1 virus first detected in Mexico spread globally (the 2009 H1N1 swine flu pandemic) and became the dominant H1N1 strain in circulation.<sup>999</sup>

The H1N1 strain causing the 1977 pandemic was nearly identical to a strain that had circulated in 1948-1950, based on comparison of hemagglutinin (H). These strains are 98.4% identical containing only four differences among the 566 amino acids that make up the protein. This indicated the derivation of the 1977 H1N1 strain from the 1950s H1N1 virus, because an H1N1 virus would not have retained 98.4% similarity in over 20 years of evolution.<sup>1000</sup>

A laboratory origin of this 1977 H1N1 virus is supported by the “molecular clock” of evolution of the 1977 H1N1 virus, the temperature sensitivity of the virus, and the apparent level of preexisting immunity among people exposed to the same strain in the 1950s.

Such a virus could have escaped from a laboratory during vaccine research, which includes a process of deliberate attenuation of influenza viruses. The process involves serial passage of a virus through chicken eggs. A side effect of this process on the virus often leads to viruses that exhibit a markedly reduced ability to replicate at higher temperatures relative to an ambient laboratory temperature (e.g., the human body), when compared to related viruses. This makes temperature sensitivity in influenza viruses an identifiable marker of likely manipulation in laboratory settings.<sup>1001</sup> The 1977 H1N1 influenza virus exhibited this temperature sensitivity when it first appeared. Relatedly, there was global interest in vaccine research for H1N1 influenza in 1977 after a swine flu outbreak at Fort Dix, NJ, in 1976. Because

H1N1 had been largely outcompeted by H2N2 influenza strains starting in 1957, researchers may have relied on stored H1N1 strains instead of “wild” samples, potentially using H1N1 strains from the 1950s.

Yet another indicator that the 1977 H1N1 virus was the reappearance of an older, unevolved H1N1 virus from about 1950 can be found in the age of the hardest-hit victims. The pandemic was restricted largely to people of 21 years of age or less. Most people older than 21 had been exposed to pre-1957 H1N1 influenza, indicating they carried substantial immunity to the reemerging strain.

Beyond the instances discussed above, the available record contains numerous instances of pathogen mishandling and mislabeling, which exposed individuals and, in some cases, infected them with dangerous pathogens in the laboratory.

#### **vi. 1978 UK Smallpox Laboratory Leak**

The last known natural case of smallpox occurred in Somalia in 1977. In August 1978, a medical photographer working at the Birmingham University Medical School became infected with smallpox and died. The source of the infection appeared to be the smallpox laboratory at the medical school that was one floor below the photographic studies where the patient worked. An exhaustive investigation considered several possible alternative scenarios that ranged from an accidental breach in safety procedures to a deliberate release of the virus.

A similar smallpox outbreak occurred at Birmingham University 12 years earlier. The index case then was a medical photographer who worked in the same studio and darkroom as the 1978 patient. While the physical layout of the laboratory changed and the safety procedures in the laboratory were enhanced in the intervening 12 years, the mode of the earlier infection was never determined.

The patient associated with the 1978 infection was a frequent user of a telephone room directly above the smallpox laboratory. Aerosol tracer studies conducted as part of the investigation showed air leakage from the laboratory particularly when personnel transited between the laboratory and an adjacent room. The opening and closing of the laboratory door resulted in the escape of the aerosol tracer material to demonstrate that an adjacent seminar room on the same floor and the telephone room one floor above became contaminated. The patient who died typically frequented the telephone room several times a day and became exposed and infected that way. This finding was made almost two years after the incident occurred.

#### **vii. Discovery of Marburg Virus**

In August 1967, laboratory workers in three European cities, Marburg and Germany, and Belgrade, Yugoslavia (Serbia) were infected with a then unknown pathogen. Thirty-one people developed severe disease with seven dying. “The source of infection was traced back to African green monkeys (*Chlorocebus aethiops*) that had been imported from Uganda and were shipped to all three locations. The primary infections ironically occurred when the monkeys were necropsied” in laboratories during polio vaccine research for the purpose of obtaining kidney cells to culture vaccine strains.<sup>1002</sup>

The monkeys served as intermediate host species as the Marburg virus' natural reservoir is believed to be African fruit bats.<sup>1003</sup> The novel virus was called Marburg virus, after the German town where the first cases were identified, despite it originating in central Africa. Marburg virus is a *filovirus*, the family to which Ebola belongs.<sup>1004</sup> Since the 1967 LAI, all other known human infections with Marburg have occurred in Africa as the result of natural zoonotic spillover. The discovery of Marburg virus is an example of the outbreak of a novel disease due to a research-related incident.



## Chapter 8: Biosafety in China's High-Containment Laboratories

### Introduction

In January 2019, Zhou et al. characterized “Biosafety is a major emerging aspect of global security... and is an integral part of national security.”<sup>1005</sup> The risks that China perceived centered on emerging infectious diseases, biological weapons and bioterrorism, misuse of biotechnology, alien invasive [agricultural] species, biological accidents, and super-resistant bacteria. Several specific concerns were mentioned. The potential for re-emergence of SARS or a highly pathogenic avian influenza, the importation of Ebola or MERS virus or some other virus such as Nipah or Hendra for example. The misapplication of synthetic biology and reverse genetics and other new biotechnologies could result in “gain of function mutations” that may have direct or indirect effects. The occurrence of laboratory infections that could endanger researchers or the public at large in the event of accidental leakage. They also described the possibility of “unexpected disasters” that could occur in “the event of a bio-accident leak, especially from a high-level biosafety laboratory.”<sup>1006</sup>

#### 1. Biosecurity in China before 2019 Reforms

In article entitled “History of and suggestions for China's biosafety legislation” submitted in June 2019 and published in August 2019, the authors described the existing national biosafety laws enacted after the 2003 SARS outbreak. By their description these laws were “no longer suitable for the current biosafety situation and require amendment and correction.”<sup>1007</sup> China implemented a series of biosecurity and biosafety legislative and regulatory reforms beginning in 2019 to 2020. These actions suggest PRC central leadership were aware of deficiencies in China's biosafety and biosecurity.

The authors cited the China's lack of a national bio-risk assessment standard. There was no professional agency to guide the establishment and operation of a bio-risk assessment system. They also noted an incomplete early-warning and forecasting system that had no standard for post-event warning to address emergent biosafety issues. They recommended accelerating legislative efforts, creating a bio-risk agency, system and establishing a biosafety monitoring and early warning system.<sup>1008</sup>

As described by PLA researchers, China's research and development of biosecurity related equipment did not start in earnest till the late 1980's and lagged “far behind the developed countries.”<sup>1009</sup> By their judgement, since 2005 following the SARS outbreak, China's National Science and Technology Program “achieved remarkable success.”<sup>1010</sup> Even with progress in developing regulations, standards and biosafety equipment; substantial challenges remained into 2018 and 2019.

Emblematic of these challenges are the conclusions of a November 2018 briefing by the Guangzhou Municipal Health Inspection Bureau. The report cited a wide range of problems found during provincial biosafety inspections of BSL-1, 2 and 3 laboratories, of which China has several thousand. Among the “common problems” identified were:

- [Biosafety] Level 1 and 2 laboratories that have not been registered in accordance with regulations;

- [Laboratories were] [n]ot proficient with activating and implementing emergency response plans when sudden accidents occur;
- Incomplete registration information such as the source of storage of and experimental projects involving various bacterial [viral] samples;
- Lack of ‘dual personnel, dual lock’ system for refrigerated storage of bacterial [viral] samples, drop area does not meet theft prevention requirements;
- Biosafety cabinets, autoclave machines, and other equipment have not been inspected according to regulations;
- Use of disinfectant products violates regulations: ultraviolet ray disinfectant lamp, disinfectant agents, concentration test card for disinfectant agents, etc...;
- Failure to disinfect the area prior to taking care of the disposal of highly dangerous waste such as cultures, samples and preservation fluid for bacterial and viral strains;
- Sub-standard management of the placement of samples after experiments are complete, especially positive samples;
- The transfer of medical waste not done promptly, especially harmful waste materials;
- Laboratory wastewater is directly released into a medical institution’s sewage management systems;
- Substandard monitoring of laboratory air and material surface disinfectants; and
- Laboratory personnel do not carry out personal protection measures according to regulations.<sup>1011</sup>

In the Spring of 2019, China’s top public health official, George Fu Gao, the Director-General of the CCDC, published an online editorial on March 25, 2019 in the *Journal of Biosafety and Health*.<sup>1012</sup> George Fu Gao warned about potential natural, accidental and deliberate biological threats. He specifically identified laboratory risks:

Man-made biological threats exist in many countries. **A potential major risk stems from stocks of concentrated infectious pathogens stored in laboratories and the absence of adequate biosecurity measures. Non-compliance of approved biocontainment and biosafety protocols could result in accidental or deliberate release of pathogens into the environment...** Advances in biomedical technologies, such as genome editing and synthetic biotechnology, have the potential to provide new avenues for biological intervention in human diseases... However, the proliferation of such technologies [genome editing and synthetic biotechnology] means they will also be available to the ambitious, careless, inept, and outright malcontents, who may misuse them in ways that endanger our safety.

For example, while CRISPR-related techniques provide revolutionary solutions for targeted cellular genome editing, it can also lead to unexpected off-target mutations within genomes or the possibility of gene drive initiation in humans, animals, insects, and plants. **Similarly, genetic modification of pathogens, which may expand host range as well as increase transmission and virulence, may result in new risks for epidemics...synthetic bat-origin SARS-like coronaviruses acquired an increased capability to infect human cells. Thus, modifying the genomes of animals (including humans), plants, and microbes (including pathogens) must be highly regulated.**<sup>1013</sup>

On May 15, 2019, Yuan Zhiming, the General Secretary of the CCP Committee within the Wuhan Branch of Chinese Academy of Sciences (CAS) and director of the WIV National Biosafety Laboratory (BSL-4), submitted an editorial for publication in the *Journal of Biosafety and Biosecurity*, for which he serves as one of two editors-in-chief. The paper was entitled “Current Status and Future Challenges of High-Level Biosafety Laboratories in China.”<sup>1014</sup>

Zhiming wrote about concerns with China’s biocontainment labs, including the WIV. He described uncertain funding for laboratory construction, operation and maintenance. These concerns ranged from neglected maintenance and insufficient operational funds to a lack of specialized managers and engineers to operate the BSL-3 labs.<sup>1015</sup> He pointed out that regulatory enforcement pertaining to pathogen waste, and laboratory animal management “still needs to be strengthened.”<sup>1016</sup> He specifically warned that such uneven implementation “puts biosafety at risk.” He also urged authorities to “promptly revise the existing regulations, guidelines, norms, and standards of biosafety and biosecurity.”<sup>1017</sup> He submitted a revised version of the paper on September 10, 2019. It was published online on October 24, 2019.

Yuan Zhiming’s concerns were echoed by others. Guizhen Wu, the CCDC biosecurity expert, submitted an article entitled “Laboratory biosafety in China: past, present and future” on August 20, 2019 that was published on October 31, 2019.<sup>1018</sup> Her perspectives were dated “as of May 2019.” She wrote of many “great [biosecurity] achievements.” She noted specifically, however, “[m]anipulation of highly pathogenic microorganisms should be performed in high-level biosafety laboratories namely BSL-3 or BSL-4.” She identified several challenges confronting China laboratory safety system:

[T]he number of high-level (BSL-4) laboratories in China is not sufficient.... **The management of laboratory biosafety in China needs improvement... the legal and regulatory standards is lacking for BSL-2 laboratories in China... [There are] not enough well-trained and experienced laboratory biosafety specialists...**[China’s] innovation capacity is relatively weak... research and development of laboratory biosafety techniques and equipment fell behind some western countries. The design and reliability of our laboratory biosafety system also lacks acute evaluation criteria and schemes.

Guizhen Wu provided additional perspectives noting that:

Administrative staff at all levels of management and laboratory technical personnel must raise their awareness and enhance the sense of responsibility. In view of national strategies, we must reexamine and adjust all aspects of biosafety, including management structures, human resources and technical systems.

She also noted that additional “biosafety laws are urgently needed.”<sup>1019</sup> These statements and concerns suggest that China’s progress in biosafety advanced slower than its aspirations for and efforts in research of highly pathogenic microorganisms.

## **2. The Launch of Legislative and Regulatory Reforms in 2018 and 2019**

The 13<sup>th</sup> National People’s Congress (NPC) Standing Committee Legislative plan released on September 7, 2018, listed biosecurity legislation as a subject requiring continuing research and discussion (Category III).<sup>1020</sup> This category is third behind topics for which draft laws are mature ready for deliberation (Category I) or those that should be rushed (Category II).<sup>1021</sup>

While the bill was initially a Category III priority, the NPC convened on March 26-27, 2019, to discuss its legislative agenda for the coming year and designated a biosecurity bill a top priority. The change priority appears to be in response to a speech given by Xi Jinping, the General Secretary of the Chinese Communist Party (CCP) on January 21, 2019.

In this speech, Xi specifically called for vigilance for ‘black swan’ incidents and guarding against ‘gray rhino’ incidents.<sup>18,1022</sup> His comments expressed concern about unexpected risks related to politics, ideology, the economy, science and technology, society, the external environment, and party building. Xi believed these seven areas could potentially give rise to “black swan” and “grey rhino” incidents. The January speech was not the first time Xi referred to “black swan” and “grey rhino” incidents.<sup>1023</sup> It does, however, appear to be the first time that he had used these two terms to describe potential security problems pertaining to science and technology.

The People’s Daily, the CCP’s official mouthpiece, summarized Xi’s remarks on science and technology as follows:

Xi Jinping emphasized that security in the field of science and technology is an important component of national security. It is necessary to strengthen system building and capacity building, improve the national innovation system, solve prominent problems such as the duplication of resource allocation, the fragmentation of scientific

---

<sup>18</sup>According to a study manual for CCP cadres, a “‘black swan’ incident refers to a major incident that is very rare, unpredictable, but as soon as it occurs, the impact trumps any and all prior experiences,” while a “‘grey rhino’ incident refers to an incident in which the problem is great, and there were early signs, but it was not given sufficient attention, and led to severe consequences as a result.”<sup>1187</sup>

research capabilities, and the unclear orientation [in terms of] the purpose and lines of innovation, and raise the overall effectiveness of the innovation system. It is necessary to speed up [the process] of addressing these shortcomings and establishing the advantages of independent innovation systems and mechanisms. It is necessary to strengthen strategic research and assessment and forward-looking deployment in major innovation areas, **paying special attention to the strategic positioning of state laboratories, reorganizing the state system of key laboratories**, building major innovation bases and innovation platforms, and improving collaborative innovation mechanisms between industry, academia, and research institutions. It is necessary to strengthen the overall planning and organization of major scientific and technological duties related to national security and economic and social development and strengthen efforts to build national strategic scientific and technological capabilities. **It is necessary to speed up the establishment of an early warning and monitoring system for scientific and technological safety and accelerate relevant legislative work** in areas such as artificial intelligence, **gene editing, medical diagnosis**, autonomous driving, drones, and service robots.<sup>1024</sup>

Several months after Xi's speech in July 2019, Xiao Gengfu, the WIV's CCP Secretary, held a WIV study session that stressed the importance of being vigilant about "black swan" and "grey rhino" incidents.<sup>1025</sup>

On July 10, 2019, Li Zhanshu, the third highest ranking member of the CCP Politburo Standing Committee and the Chairman of the National People's Congress (NPC) Standing Committee, chaired a symposium to discuss drafting a biosecurity law. This initiative came on the heels of passing the vaccine safety law a month earlier.<sup>1026,1027,1028,1029,1030</sup> Significantly, he framed the initiative as a response to Xi Jinping's instruction. The symposium seems unrelated to any known domestic infectious disease outbreak at the time and occurred seven days before the WHO declared a Public Health Emergency of International Concern (PHEIC) for the Ebolavirus outbreak in the Democratic Republic of Congo.<sup>1031</sup> During the gathering, Li stated:

[We must] **deeply carry out the instructions and requirements of General Secretary Xi Jinping, insist on the necessity and urgency of the biosecurity law** based on an full awareness of the holistic view of national security, use legislation to establish a basic system and principles for the realm of biosecurity, **give prominence to risk prevention**, [and] **use the law as a weapon to defend the biosecurity** of the state and guarantee healthy lives for the people.<sup>1032</sup>

Li's comments also suggested a concern about the misuse of biotechnology. Specifically, he stated:

[We must] use legislation to guide and standardize the research and application of human biotechnology to walk the correct path, spur the

healthy and speedy development of biotechnology, [and] prevent and reduce the dangers and losses that could occur.<sup>1033</sup>

Drafted in July, the draft law was passed out of committee on September 19, 2019.<sup>1034</sup> Zhanshu, chairing the National People's Congress Standing Committee, reviewed it on October 21, 2019. Preventing and prohibiting the use of biological agents and biotechnology to harm state security was described by the NPC leadership as the "main point" of the legislation.<sup>1035</sup> It was ultimately passed into law a year later October 17, 2020.

During the first reading of the bill in October 2019, Gao Hucheng, the chairman of the NPC Environmental Protection and Resources Conservation Committee, delivered the official explanatory report articulating the purpose of the legislation and summarizing its key points. Gao cited the leak of biological agents from laboratories as a threat to state security that warranted the passage of the law.<sup>1036</sup>

Gao Hucheng's comments were striking in their urgency, and suggested awareness of problems that were not public knowledge:

At the same time that biotechnology has brought progress and benefits to humanity, it has also brought new biosecurity problems and threats. **Currently the biosecurity situation in our country is grim.** Bio-warfare and traditional biological threats from major emerging and sudden outbreaks of infectious diseases represented by SARS, Ebola, and African Swine Fever, as well as animal and plant epidemics, are occurring as frequently as ever before. Non-traditional biological threats, [such as] bioterrorist attacks, **the erroneous use and deliberate misuse of biotechnology, and laboratories that leak biological agents, are clear and obvious.**<sup>1037</sup>

Gao Hucheng's characterization of the state of China's life sciences was critical:

**Currently our country's research and development of biotechnology and construction of [research] infrastructure are relatively backward. Large disparities exist in technology, products, and standards.** There are few original biosafety technologies [that were invented in China] and few outstanding [research] achievements.<sup>1038</sup>

In response to this poor state of affairs, Gao Hucheng's advocated for the PRC to:

[I]ncorporate the building up of the state's biosecurity capabilities into the law, fix industrial policies and science and technology policies that encourage independent innovation in the form of the law, firmly grasp the critical and core biotechnologies, [and] **protect and promote the development of our nation's biotechnology and enhance our ability to prevent dangers and threats.**<sup>1039</sup>

The timing of his remarks precludes the likelihood that the impetus for this legislation was the brucella vaccine incident in Lanzhou. An accidental aerosol leakage of brucella occurred at a veterinary vaccine plant. The incident was detected in November 2019 and infected between 6,000 to 10,000 individuals.

### **3. The Biosecurity Law of the People's Republic of China: October 2020**

The law's preamble emphasizes the principles of biosecurity and biosafety for all levels of government. It specified the law was drafted:

for the purpose of maintaining national security, preventing and responding to biosecurity risks, safeguarding people's lives and health, and protecting biological resources and the ecological environment.<sup>1040</sup>

Of the six major provisions in the law, four are noteworthy: 1) Biosecurity Risk Prevention and Control, 2) Prevention and Control of Major Emerging Infectious Diseases, 3) Biotechnology Research, Development and Safety, and 4) Biosafety of Pathogen Microbiology Laboratory. The other two provisions are devoted to Human Genetic Resources and Biological Resource Security and Prevention of Bioterrorism and Bioweapon Threats.

The Biosecurity Prevention and Control provision establishes a national biosecurity monitoring and early warning system. This activity is coupled with biosafety risk assessments, biosafety investigations and a related information sharing system. Information concerning biosafety including the overall biosafety situation and warnings of major incidents are intended to inform a national level coordination mechanism. This system would also monitor and, as necessary, investigate incidents or outbreaks.

The Biosafety of Pathogen Microbiology Laboratory provision outlines actions to strengthen the management of laboratories involved in pathogen research and improve adherence to national standards and requirements for biosafety. It specifies that:

[L]ow-level pathogenic microorganism laboratories shall not engage in pathogenic microorganism experiments that should be conducted in high-level pathogenic microorganism laboratories...High-level pathogenic microorganism laboratories engaging in experimental activities of highly pathogenic or suspected highly pathogenic microorganisms shall be approved by the health or agriculture and rural authorities at or above the provincial level. For pathogenic microorganisms that have not been discovered [found in nature] or have been eliminated...relevant experimental activities shall not be carried out without approval.<sup>1041</sup>

It also outlines measures to strengthen management of experimental animals. It explicitly mentions taking steps to prevent the escape of laboratory animals and expressly forbids putting "used

laboratory animals into the market.” Finally, it outlines improvements of security measures to “ensure the safety of the laboratory and its pathogenic microorganisms.” It specifically requires that high-level pathogenic microbiology laboratories to

[A]ccept the supervision and guidance of public security organs and other departments on laboratory safety and security and strictly prevent the leakage, loss, theft and robbery of highly pathogenic microorganisms.<sup>1042</sup>

The state of China’s biosafety and biosecurity in 2019 was a matter of broad concern by leaders in the national government, public health and at scientific research institutions such as the WIV. Published statements and written essays highlighted the need to update biosafety and biosecurity policies and laws that were drafted following the 2002-2003 SARS outbreak. Specific concern was directed at recombinant research that involved potential pandemic pathogens specifically bat coronaviruses. Concerns also identified the lack of consistent enforcement of existing biosafety and biosecurity regulations; inadequate number of high-containment (BSL-3 and BSL-4) laboratories; and insufficient funding for biosafety training, staffing, biocontainment operations and maintenance.

China’s national government responded to these concerns by drafting a comprehensive biosafety and biosecurity law in the Summer of 2019. Ironically, this draft legislation passed out of the National People’s Congress Standing Committee just prior to the pandemic’s outbreak in October 2019. The political action taken in response to what appears to be broad challenges to China’s biosafety and biosecurity particularly at high biocontainment laboratories appeared appropriate but unfortunately may not have been timely.



## Chapter 9: The Wuhan Institute of Virology & Other Wuhan Institutes with High-Containment Laboratories

### Introduction:

The “Chinese Academy of Sciences Wuhan Institute of Virology” (WIV)<sup>1043</sup> was founded in 1956 and is among the oldest national research institutions having been established shortly after the creation of the People’s Republic of China.<sup>1044</sup> The WIV adopted its current form in June 1978 when it was placed under the control of the Chinese Academy of Science (CAS).<sup>1045</sup> The WIV answers directly to the Wuhan branch office of CAS and the CAS headquarters in Beijing. It does not report to the Wuhan municipal authorities. CAS, in turn, answers directly to the State Council, the PRC’s equivalent of the cabinet. Since the 2002 SARS outbreak, the WIV has “extended its research areas from agriculture and environment-related fields to medicine-related disciplines in order to meet the national strategic demand of public health, national security, and sustainable agriculture development.”<sup>1046</sup>

### 1. Background and Early History of the Wuhan Institute of Virology

The U.S. State Department estimates that the WIV employees approximately 1,500 staff.<sup>1047</sup> In applications to U.S. grant making agencies, the WIV is reported as having “14 professors, 36 associate professors, and 47 assistant professors conducting research on virology.”<sup>1048</sup> As of 2018, the WIV is organized into three research departments and one center: the Department of Molecular Virology, the Department of Bio-control, the Department of Analytical Biochemistry, and Biotechnology, and the Virus Resource and Bioinformation Center of China, which contained approximately 800 viral strains as of 2018 making it the largest virus bank in Asia.<sup>1049</sup>

The WIV also has a number of other projects and offices, including the Key Laboratory of Molecular Virology of the Chinese Academy of Sciences, the Joint-Laboratory of Invertebrate Virology, HIV Pre-screening Lab and Hubei Engineering and Technology Research, Center for Viral Diseases.<sup>1050</sup> The institute has 14 research groups, including the Emerging Viruses Group, run by Dr. Shi Zhengli. Additional offices within the WIV are the Analytical Equipment Center, an Experimental Animal Center, and the Editorial Office of “*Virologica Sinica*”.<sup>1051</sup>

WIV’s new Zhengdian campus is located on the southwest outskirts of Wuhan approximately 15 miles from the original WIV campus. Its construction took 11 years starting in 2004 and was completed on January 31, 2015. The total cost was \$44 million USD. The BSL-4 lab was accredited by the China National Accreditation Service in February 2017.<sup>1052</sup> A two-year accreditation process is not unusual for such high-containment facilities. Its construction reflects the government’s prioritization of SARS-related and other emerging highly infectious disease research.

Publicly available budget information from the WIV shows that the WIV’s total operating budget in 2020 of \$48 million USD. Notably, approximately 40% of the WIV’s revenue comes from “business income” which is defined as “professional business activities and auxiliary activities carried out by public institutions.” The WIV’s budget for “laboratories and related facilities” is approximately \$1.3 million USD. It is unclear if this total includes the budget for operating the BSL-4 laboratory or just the BSL-2,

BSL-3, and ABSL-3 laboratory suites. However, it appears that the budget for the BSL-4 laboratory, and perhaps the entire new Zhengdian campus, is \$9.88 million USD, as stated it is unclear if this figure includes ongoing construction costs and laboratory maintenance.

While accredited in 2017, the BSL-4 laboratory only began operations in January 2018 after receiving permission by China's National Health and Family Planning Commission (NHFPC) to initiate research on three specific highly contagious viruses: Ebola, Nipah, and a variant of Crimean-Cong hemorrhagic (Xinjiang) fever.<sup>1053</sup> As noted by the U.S. State Department, the WIV BSL-4 was initially denied permission to work on human adapted SARS virus by the NHFPC though the rationale for that denial is not clear.<sup>1054</sup> Dr. Shi Zhengli was a western trained BSL-4 researcher studying SARS and MERS. As noted in the 2018 U.S. State Department cable, “[i]t is interesting that WIV scientists are allowed to study SARS-related coronaviruses isolated from bats while they are precluded from studying human-disease causing SARS coronavirus in their new BSL-4 lab.”<sup>1055</sup> This investigation could not determine when or if the NHPC granted WIV permission to study human-causing SARS coronaviruses.

In January 2018, it was also noted that the facility had a serious shortage of appropriately trained technicians and researchers need to “safely operate this high-containment laboratory.”<sup>1056</sup> The University of Texas Medical Branch in Galveston Texas funded by NIAID trained WIV researchers and technicians in high-containment biosafety procedures. According to the U.S. State Department, this collaboration “may help alleviate this talent gap over time.”<sup>1057</sup>

All CAS research institutes have been subjected to political pressure to produce scientific breakthroughs and advance indigenous innovation. The WIV may have been subjected to greater pressure because it was China's first BSL-4 laboratory. As early as 2014, Xi Jinping highlighted the importance of the WIV's new lab, noting that “*the construction of the P4 [BSL-4] laboratory is of vital importance to Chinese public health.*”<sup>1058</sup> Until 2018, the WIV was home to the only BSL-4 laboratory in China.<sup>1059</sup> CCP leaders and state-run media repeatedly touted the Wuhan National Biosafety Laboratory as a national milestone for China that would lead to major advances in science and public health. In addition to hosting the WIV also hosts the “Center for Biosafety Mega-Science,” one of only three large, multidisciplinary “mega-science” research centers nationwide, which were established to promote collaboration across various specialties to promote innovation.<sup>1060</sup>



Figure 52: Wuhan institutes conducting coronavirus related research. Wuhan Institute of Virology campuses circled. *Source:* BSL Laboratories in Wuhan and their roles in coronaviruses research. <https://gillesdemaneuf.medium.com/overview-of-biological-laboratories-in-wuhan-with-their-roles-in-coronavirus-research-bca6c1cd1f74>

## 2. Chinese Academy of Science (CAS), WIV's Parent Agency

The CAS is the PRC's premier organization for science and technology (S&T) research and development. While it may bear a superficial resemblance to academic institutions in the West, CAS is distinct in important ways.<sup>1061</sup> As one expert cautions: “[t]he portrayal of the Chinese Academy of Sciences is a difficult task because traditions and the conditions for scientific research in China differ from those in the Western world in almost every respect.”<sup>1062</sup> CAS is massive, boasting 61,000 personnel spread across 104 research institutes, 12 branch academies, and two universities.<sup>1063,1064</sup> Looking at its relative size, the CAS dwarfs similar academic institutions in the West. More than 85 percent of China's large-scale science facilities belong to CAS.<sup>1065</sup> It operates on a budget of approximately RMB 42 billion (US\$6.7 billion) with most of its funds coming from the PRC government.<sup>1066</sup> This investigation examined CAS because the Wuhan Institute of Virology is a CAS research institute.<sup>1067</sup>

Moreover, CAS is not only state-funded, but also state-run. It is the primary research and development arm of the PRC government in natural and applied sciences.<sup>1068</sup> Although many research institutions outside of China likewise rely heavily on state support, they generally enjoy considerable autonomy to pursue research as they see fit. By contrast, CAS and other state-run research institutions exist, first and foremost, to serve the party-state and its top-down approach to research and innovation.<sup>1069</sup> The CCP does not regard them as independent entities.<sup>1070</sup>

The CAS founding charter describes its mission as: “[u]nder the leadership of the Central Committee of the Chinese Communist Party and the State Council... [CAS] takes part in the development of science and technology and contributes to the building up of a modern, socialist, and strong state.”<sup>1071</sup> CAS is one of 18 government and party entities whose personnel matters are overseen by the Talent Work Coordination Small Group of the CCP Central Committee’s Organization Department.<sup>1072</sup>

Finally, CAS is not a purely civilian institution. It is civilian insofar as it is subordinate to the State Council, the highest executive organ of state power and roughly the equivalent of the cabinet, rather than to the Central Military Commission.<sup>1073</sup> The civilian structure of CAS does not, however, preclude the PLA from having a role at CAS, nor does it exempt CAS from the political imperative to advance the PLA’s research agenda. To the contrary, much of the work done at CAS contributes to products for military use.<sup>1074</sup> CAS researchers work for and with the PLA in various ways.

The CAS has had “an extensive history of involvement in the development of the country’s most advanced civilian and military technologies since its inception,” according to one expert on China’s defense industry.<sup>1075</sup> Dual-use research collaboration between CAS and the PLA is ongoing, formalized and has expanded since 2015 as a result of Military-Civil-Fusion (MCF).<sup>19,1076</sup> Classified studies are conducted at the CAS on a routine basis.<sup>1077,1078</sup> The CAS research agenda is largely dictated to it by the party-state, and the pursuit of explicitly dual-use goals and applications is common.<sup>1079</sup> CAS researchers regularly collaborate with PLA counterparts,<sup>1080</sup> host them as visiting researchers at CAS facilities,<sup>1081</sup> participate in joint trainings,<sup>1082</sup> and engage in professional exchanges.<sup>1083</sup> The WIV is no exception this practice.

### 3. WIV Collaborations with PLA-AMMS

The People’s Liberation Army (PLA), the armed wing of the CCP, has played an outsized role in the development of the life sciences since the founding of the PRC in 1949. Biological research conducted by the PLA takes place primarily under the auspices of the Academy of Military Medical Sciences (AMMS), which was founded in 1951.<sup>1084</sup> The AMMS has historically spearheaded the construction of biocontainment labs in China, having built the PRC’s first modern BSL-3 laboratory in 1987.<sup>1085</sup> AMMS has 11 subordinate research institutes, the most important of which for the purposes of this investigation is the Institute of Microbiology and Epidemiology in Beijing, which studies the pathogenesis of microorganisms, conducts epidemiological studies, and carries out basic and applied research in virology, parasitology, and bacteriology.<sup>20</sup>

---

<sup>19</sup> Dual-use refers to technology and research that can be used for both peaceful and military purposes.

<sup>20</sup> As recently as 2021, the United States expressed BWC compliance concerns with respect to toxin research and development being conducted at military medical institutions in China because of the dual-use applications and their potential as a biological threat. In December 2021, the US Department of Commerce added the AMMS to its export blacklist over concerns about its misuse of emerging biotechnologies, including gene editing, human performance enhancement, brain machine interfaces, and biological materials. Ellen Nakashima and Aaron Schaffer, “Biden Administration Places Top Chinese Military Institute on Export Blacklist over its Use of Surveillance, ‘Brain-Control’ Technology,” *The Washington Post* (Online), 16 December 2021.

The AMMS also engages in the development of pharmaceuticals and medical countermeasures, including vaccines, antibodies, antimicrobial and antiviral drugs, and diagnostic testing.<sup>1086</sup> The existence and level of collaboration between the WIV and the People's Liberation Army has been a source of controversy. WIV coronavirus expert Shi Zhengli has denied that the WIV conducts classified research or collaborates with PLA scientists. By contrast, the U.S. State Department and a former Director of National Intelligence assert the opposite.

This investigation has concluded that the PLA has a permanent presence at the WIV, that WIV researchers collaborate on a range of research with PLA scientists, and that the WIV conducts classified research. A review of academic publications demonstrates that the WIV collaborates with the PLA's Academy of Military Medical Science (AMMS) on a regular basis. For example, a paper titled "Molecular Mechanism for Antibody-Dependent Enhancement of Coronavirus Entry," submitted for publication in November 2019, featured WIV coronavirus expert Shi Zhengli and one of her team members partnering with PLA AMMS scientists Zhou Yusen, Sun Shihui, He Lei, and Chen Yuehong.<sup>1087</sup> Earlier in 2019, another WIV research group partnered with a PLA AMMS research group to study the role of calcium channel blockers in reducing fever in patients suffering from thrombocytopenia syndrome virus.<sup>1088</sup> A total of 10 PLA researchers participated, eight of whom worked for AMMS.<sup>1089</sup>

A 2015 book written PLA researchers and published by the PLA entitled *The Unnatural Origin of SARS and New Species of Artificial Humanized Viruses as Genetic Weapons* suggests, despite other published peer-reviewed literature, the 2003-2004 SARS outbreak was likely the result of deliberate laboratory development rather than natural zoonotic event.<sup>1090</sup> The book was submitted to the journal *The Lancet* for formal peer review in 2012 but was not accepted for review or publication. Sixteen of the 18 contributing authors of the book were from the AMMS. There were no authors or contributors, however, from the WIV.

In 2017, Shi Zhengli and 10 other WIV researchers worked with 13 PLA AMMS researchers to conduct a study funded in part by the U.S. National Institutes of Health (NIH) and U.S. Agency for International Development (USAID) that found a bat coronavirus to be the cause of a fatal diarrhea syndrome among swine.<sup>1091</sup> In 2015, WIV researcher Wang Hanzhong won an award from the PLA General Logistics Department for his "close cooperation" with the PLA AMMS and the PLA No. 302 Hospital on a study of emerging pathogens that infect the respiratory channel and intestinal track.<sup>1092</sup> These examples of WIV-AMMS collaboration were drawn from the public domain and are illustrative and not exhaustive. The WIV has engaged in classified and military-affiliated research, including laboratory animal experiments, with the PLA since at least 2017.<sup>1093</sup>

Personnel employed by the PLA AMMS appear to maintain a working presence at the WIV, and in some cases, serve in institutional roles. An example of the latter is Colonel Cao Wuchun, the Executive Director of PLA AMMS Institute of Microbiology and Epidemiology, who sits on the scientific advisory committee for the WIV Center for Emerging Infectious Diseases led by Shi Zhengli.<sup>1094</sup> Two other PLA scientists also serve on that advisory committee.<sup>1095</sup>

AMMS Professor Zhou Yusen, Shi Zhengli's collaborator in the 2019 project, worked with the WIV, and likely at the WIV, at least episodically, for several years.<sup>1096</sup> A WIV report from 2016

identified Zhou and one of his doctoral advisees as key partners in a study that sought to develop a vaccine for MERS-CoV.<sup>1097</sup> Zhou may have been working at the WIV in the Fall of 2019 when the research was being conducted for the paper that he coauthored with Shi Zhengli and Chen Jing on antibody-dependent enhancement of coronavirus entry.<sup>1098</sup> There is to believe Zhou was engaged in coronavirus animal vaccine research with the WIV in the Summer and Fall of 2019. The Intelligence Community might be able to better explore this possibility.

Another example of the PLA AMMS operating at the WIV appeared in connection to China's epidemic response. On January 30, 2020, the PLA acknowledged that it had dispatched a team of AMMS experts, led by epidemiologist and virologist Major General Chen Wei, to guide the emergency response in Wuhan.<sup>1099</sup> Chen reportedly arrived in "mid-January" to lead the epidemic response team. She also appears to have taken control of directing the operations of the WIV for some period of time.<sup>1100,1101</sup>

#### **4. Other High-Containment Laboratories in Wuhan**

Wuhan, the capital of Hubei province and the largest city in central China, is a major center for basic research in the life sciences and biopharmaceutical production. In April 2019, the General Office of the Wuhan Municipal People's Government issued a detailed 25-page development plan aimed at building a comprehensive health industry by 2035 with the BSL-4 lab at the Wuhan Institute of Virology as a key driver for the development of the city's broader health industry.<sup>1102</sup>

As of August 2022, Georgetown University's Center for Security and Emerging Technology (CSET) reports that China has 69 research institutions with BSL-3 laboratories, making the country home to the second largest number of BSL-3 laboratories in the world after the United States.<sup>1103</sup> As of 2019, Wuhan was home to nine institutions with BSL-3 or ABSL-3 laboratories:

- Wuhan Institute of Virology
- Wuhan University Institute of Animal Models
- Huazhong Agricultural University
- Hubei Animal Disease Prevention and Control Center
- Hubei Center for Disease Prevention and Control

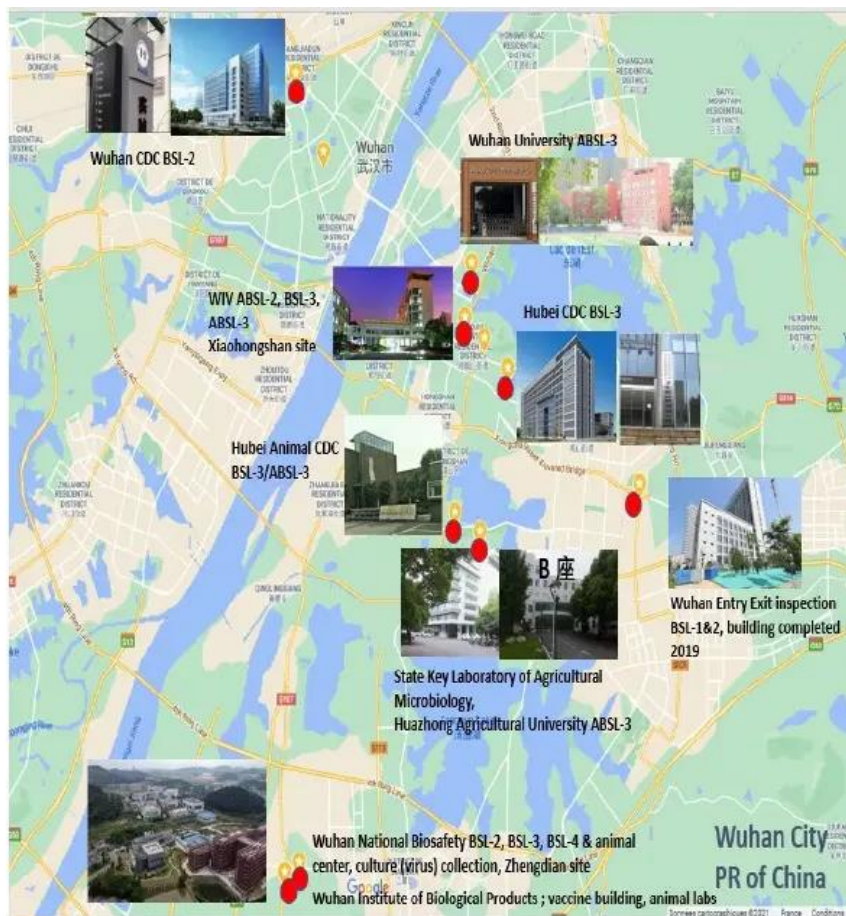

Figure 53. Graphic location of High-containment Laboratories in Wuhan. Source: BSL Laboratories in Wuhan and their roles in coronavirus research. [Biological Laboratories in Wuhan and their roles in coronavirus research](#) | by Gilles Demaneuf | Apr. 2022 | Medium | Medium

Of the several Wuhan institutes with high-containment laboratories, the Wuhan University's

Institute of Animal Models played a historic and contemporary role in researching coronaviruses and evaluating SARS vaccines. Noted recently for its basic and translational research in cardiometabolic disease, Wuhan University was a significant epicenter of early SARS-related research after the 2002-2003 outbreak.<sup>1104</sup> Researchers from the University published studies on the first inactivated viral SARS vaccine tested in non-human primates in collaboration with the WIV.<sup>1105, 1106</sup> In 2018, researchers published a study evaluating the risk of antibody dependent enhancement from an inactivated SARS vaccine.<sup>1107</sup>

A 2016 European Heart Journal article that featured the Institute and its Director Professor Li Hongliang. The Institute was described as “well-equipped” to perform gene modification, micromanipulation, and animal management. It has considerable experience in genome editing techniques. It boasted over 1000 genetically engineered animals that included mice, rats, rabbits and non-human primates. The Institute’s research team consists of over 100 personnel including professors, scientific staff, post-doctorates, graduate students, and technicians. They were described as having extensive research experience in the fields of microbiology, medical virology, immunology, pathology, cell biology, molecular biology, pharmacology, clinical laboratory medicine, radiology, veterinary, and laboratory animal medicine.<sup>1108</sup>

## **5. Biosafety Conditions and Practices at the WIV**

### **a. Background**

There is no reason to believe the WIV is an exception from the shortcomings and problems in China’s biosafety field detailed in Chapter 8. In fact, publicly available information suggests that the WIV suffered from many of the same biosafety shortcomings as other laboratories in China. As early as 2015, some western scientists called into question whether the potential benefits to be gained from the WIV’s research involving the artificial manipulation and creation of chimeric coronaviruses was worth the considerable risks to public health inherent to this line of research.<sup>1109</sup> In 2017, other scientists warned of the potential dual-use applications of such research, and worried about “pathogens escaping” in light of China’s history of laboratory leaks, particularly several laboratory-acquired infections involving SARS.<sup>1110</sup> In a November 2019 internal description of their work situation, WIV BSL-4 researchers had to overcome “the three no’s” in the initial construction and operation of their laboratory: “no equipment and technology standards, no design and construction teams, and no experience operating or maintaining” a high-containment laboratory.<sup>1111</sup> They further described successfully overcoming these challenges though it stands as evidence of initial shortcomings.

### **i. BSL-2, BSL-3, and ABSL-3 Laboratories**

The WIV’s original Xiahongshan campus BSL-3 and ABSL-3 laboratories were certified by the Chinese National Academy of Sciences in 2008 with pathogen work beginning in 2009-2010 after receiving approval from the National Health Commission. Prior to the BSL-3 going into operation, the WIV only had BSL-2 and ABSL-2 facilities. This investigation was unable to determine the number of BSL-3 and ABSL-3 laboratory suites at the Xiahongshan campus.

### **ii. BSL-4 Laboratory**



The WIV's BSL-4 laboratory complex, formally known as the Wuhan National Biosafety Laboratory, was China's first biocontainment lab built to study the world's most dangerous pathogens,<sup>1112</sup> and is part of a system of national laboratories, many of which are CAS facilities, under development for the express purpose of combining work in both civilian and defense-related fields as well as encouraging multidisciplinary research.<sup>1113</sup> It was promoted by the Vice-resident of CAS, Zhang Tao as "improving China's capabilities in strengthening the national biosafety, as well as in constructing the response system to public health emergency."<sup>1114</sup>

China collaborated with the Jean Merieux BSL-4 laboratory in Lyon, France which assisted with construction of the 3000 m<sup>2</sup> BSL-4 Zhengdian laboratory.<sup>1115</sup> Construction of the Zhengdian campus physical facilities were completed in 2015.<sup>1116</sup> In addition to the BSL-4 laboratory, BSL-2 and BSL-3 laboratories are located there. The BSL-4 laboratories were as certified as meeting the standards and criteria of BSL-4 by the China National Accreditation Service for Conformity Assessment in January, 2017<sup>1117</sup> with the National Health Commission approving them in November, 2018. The campus also has experimental animal BSL-3 facilities.<sup>1118</sup> As of the start of the COVID-19 pandemic in late-2019, several buildings on the campus appear to be still under construction.

BSL-4 laboratory construction began in 2005 and took 10 years and the physical structure was completed in January 2015. During this prolonged construction period, the joint venture between the French and Chinese to build the laboratory began to break down. The initial development plan called for a French engineering company to oversee and certify the laboratory's construction, but the company withdrew from the project in 2007.<sup>1119</sup> Instead, it appears that French companies were limited to drafting the laboratory's design while Chinese companies, with no experience in building high-containment laboratories, managed the construction.

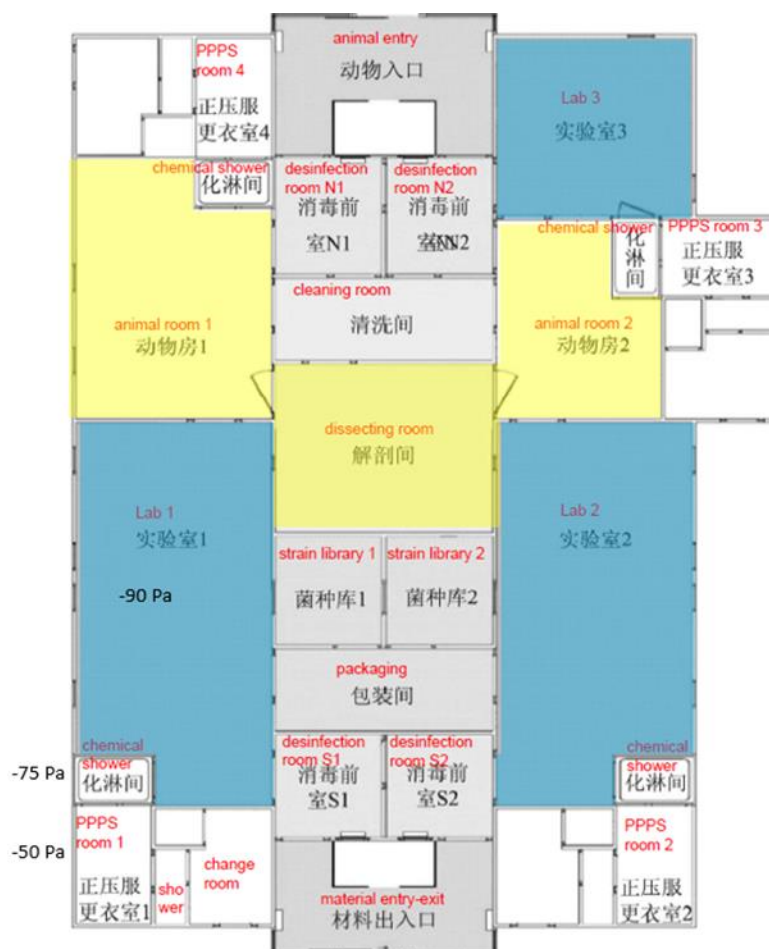

Figure 54. Graphic layout of Wuhan Institute of Virology Biosafety Level Four (BSL-4) Laboratory. Source: Wuhan BSL-4: Engineering Review <https://gillesdemaneuf.medium.com/wuhan-bsl-4-engineering-review-aec66a18f858>

During construction, WIV made a number of changes to the French design. The WIV also added an additional laboratory to the “hot zone” which required making changes to the design that increased the number of doors in one of the two disinfection rooms at the entrance and exit of the “hot zone.” Among the most radical was changing the structure of the “hot zone’s” (the interior laboratory space where experiments with pathogens take place) outer wall from steel faced urethane panels approximately 5" thick, joined with silicon sealant and cam action locks to two 3mm thick sets of stainless-steel panels laser welded together with a small air gap between the two sets of panels. The welded stainless-steel panel system was developed by the WIV to meet the high-level containment needs posed by experiments on living animals that could result in the spread of infectious aerosols:

[T]he biosafety facility will be filled with high-dose and highly pathogenic biological agents from infected animals....To prevent the spread of pathogenic microorganisms to the outside, dynamic containment measures (a differential pressure gradient in laboratory rooms) are typically implemented to ensure a strict and controlled differential [negative] pressure gradient in functional areas.<sup>1120</sup>

According to the WIV design team, the stainless-steel welded construction offered several advantages: a short construction period, low cost, easy maintenance and “suitability for cell-level and small- and medium-sized animal infections studies.”<sup>1121</sup> The authors maintained that the lab, likely at China’s non-operational BSL-4 test facility in Tianjin, remained airtight for over 10 years after “numerous gaseous fumigation and sterilization experiments with formaldehyde, vaporized hydrogen peroxide and chlorine dioxide.”<sup>1122</sup> The study, however, did not comment on evaluating the potential corrosive effects of liquid topical disinfectants.

### iii. Overcoming the “Stranglehold Problem”

With relatively few exceptions, Chinese enterprises remain dependent on foreign sources for core technologies.<sup>1123</sup> This dependency is referred to as the “stranglehold problem.” It remains a recurring theme of concern at the CAS and other state-run research institutions charged with meeting the science and technology goals set by Beijing, including the WIV. It refers to the “direct [deleterious] effects created by cutting off the supply of foreign critical and core technologies” to China.<sup>1124</sup> There are technologies that China “must import because it is unable to produce them domestically in sufficient quality or quantity.”<sup>1125</sup> A primary goal of China’s economic plan for 2021-2025 is for officials to “target industrial weak links, implement projects to tackle key problems with key and core technologies, and solve a series of ‘stranglehold’ problems as soon as possible.”<sup>1126</sup>

Beyond simply reducing China’s reliance on foreign technologies, the CCP leadership speak of an “urgency for China to transform its economic development model from one that is labor, investment, energy, and resource-intensive into one that is increasingly dependent on technology and innovation.”<sup>1127</sup> CAS is critical to that economic transformation. As China reaps fewer and fewer dividends from the resource and labor-intensive model that drove its growth from the 1980s until the early 2000s, greater demands were placed on the S&T research system, and CAS in particular.<sup>1128</sup> CAS itself also felt the weight of justifying whether it deserved the resources it consumed. Reports indicate that skepticism existed within China about the wisdom of maintaining such a massive research organization, much larger than any other comparable organization elsewhere in the world, and one that is entirely dependent on the government funding.<sup>1129</sup>

The amount of investment in general research and development (R&D) China has made compared to the U.S. has increased from 5% in 1991 to 44% in 2010. China’s growth in R&D expenditure is at 20% per year. This increase is the result of the growth in China’s gross domestic product (GDP) and the increased percentage of the GDP spent on R&D.<sup>1130</sup> The modernization, reform and large investment reflects the CCPC’s leadership vision of building China into a modern S&T power.<sup>1131</sup>

### b. Evidence of WIV Biosafety Shortcomings Prior to 2019

Early reports from the WIV suggest breaches in lab safety standards dating back years. In January 2011, an inspection of WIV laboratories working with pathogens “discovered that some research groups and support departments did not meet the standards in certain areas and had hidden safety dangers with the storage of bacterial and viral samples and aspects of their experimental activities.”<sup>1132</sup>

On January 19, 2018, U.S. diplomats conveyed concerns about the training of personnel and biosafety conditions after visiting the newly constructed BSL-4 laboratory complex located on the WIV's Zhengdian Research Industrial Park campus in the Jiangxia District of Wuhan<sup>1133</sup> in a State Department cable.<sup>1134</sup> According to an April 2020 Washington Post article, the January 19 cable stated that, “during interactions with scientists at the WIV laboratory, they noted the new lab has a serious shortage of appropriately trained technicians and investigators needed to safely operate this high-containment laboratory.” The cable further cautioned that the WIV's work with bat coronaviruses potentially posed a risk of a SARS-related pandemic.<sup>1135</sup>

Concerns about biosafety at the WIV continued to be mentioned periodically throughout internal reports obtained by this investigation. For example, a report about biosafety inspections at the WIV conducted in 2018 “raised security management requirements to target problems that were found during comprehensive security inspections,”<sup>1136</sup> and “used recent cases of specific safety procedural [breaches] during research and development and production drawn from around the country as a warning.”<sup>1137</sup>

On September 10 and 14, 2018, the WIV held meetings where a number of its strategic goals and challenges were discussed.<sup>1138</sup> The reports suggest that WIV leadership was aware of biosafety and biosecurity problems – problems that would be discussed with greater frequency and urgency in 2019. During the meetings, Chen Xinwen, director of the WIV from 2008 to late 2018, brought attention to unspecified “shortcomings and inadequacies in the current work at CAS.”<sup>1139</sup>

Chen Xinwen also, “highlighted the imperative to tightly grasp the critical [technological] fields and the ‘stranglehold’ problem that affects the overall situation of the nation and its long-term development.”<sup>1140</sup> Further, Chen Xinwen stressed that the WIV should, “push forward with the establishment of the Center for Biosafety Mega-Science... complete the work of setting up a system to manage secrets at the institute.”<sup>1141</sup> Xiao Gengfu, Secretary General of the CCP Committee at the WIV, added the following comments:

The current situation for science and technology in our nation is pressing, the challenges are pressing, [and] the mission is pressing. We must... solve our shortcomings and the ‘stranglehold’ problem and make contributions to the great rejuvenation of the Chinese race, the nation, and the people.<sup>1142</sup>

On December 24, 2018, the WIV's parent organization, the Wuhan Branch of the Chinese Academy of Sciences (CAS) held an end-of-the-year political work meeting in which the work of 2018 was recapped and general goals for 2019 were discussed. Echoing the September 10 and 14 reports from the WIV, a senior CCP leader at the Wuhan Branch of CAS told its management to “...focus on the major science and technology tasks to meet the current urgent needs of the nation and the strategic needs for its long-term development, [and] focus on the ‘stranglehold problem’ of key and core technologies...”<sup>1143</sup>

## 6. Chronology of WIV Biosafety Concerns in 2019

Internal WIV reports, patents, and academic writings suggest that the WIV continued to battle the “stranglehold problem” as it attempted to achieve the technological and research targets set for it by the country’s leadership. Based on the information reviewed by this investigation, it appears that efforts to innovate around the stranglehold problem and the lack of access to western technology met with mixed results. Limitations in developing domestic biosafety technologies are reflected in a short suspense, single source procurement request for French-made positive air-pressure suits in March 2019 and a series of patents filed by WIV researchers. The WIV also began a series of repairs and renovations to its laboratory facilities at its Zhengdian campus in the Summer and Fall 2019.

As in 2018, biosafety and biosecurity deficiencies remained a concern with WIV leadership extolling employees to be aware of “hidden dangers” associated with their work in high-containment laboratories, including during a state secret training session. Lastly, this investigation found the earliest potential preparatory action by a PRC government agency when, in May multiple PRC government agencies based in Hubei, including the provisional CDC and a PLA managed hospital began to increase purchases of PCR equipment used to diagnose viral infections, including coronaviruses and influenza.<sup>1144</sup>

**a. March to April 2019: WIV’s BSL-4 Renovations, Annual Safety Training, and Biosafety Patents Filed**

**i. Series of WIV Repairs and Renovations Begin**

The WIV submitted several procurement requests for major renovation and maintenance projects involving their relatively new BSL-3 and BSL-4 laboratory facilities at the Zhengdian campus during 2019. The first two of which were filed in March, according to research by the minority staff of the U.S. House of Representatives Foreign Affairs Committee, citing the original Chinese language documents from PRC government procurement website.<sup>1145</sup>

On **March 1**, 2019, the WIV issued a procurement notice on a PRC government website seeking contractors to bid on a maintenance project at a BSL-3 laboratory and laboratory animal center at the new Zhengdian Park campus, with a reported budget of US \$401,284.<sup>1146</sup> The nature of this project is not known.

On **March 21**, 2019, the WIV issued a short notice, single source procurement notice seeking to purchase 20 sets of French positive pressure protective suits and allotted a budget of US\$177,161 (150,000 Euros).<sup>1147</sup> The purchasing agent was Hong Kong Yi’an Huawei Co., Ltd. These suits are an integral part of the personal protection equipment used in BSL-4 laboratories; however, the requested location was the WIV Xiaohongshan location rather than the Zhengdian where the BSL-4 laboratory is located suggesting enhanced BSL-3 level research. Of note, the French Dual-Use Commission reportedly declined a similar WIV request to purchase additional containment suits in 2016 because the volume was “well above the needs of the Wuhan [lab],” and fueled French concerns that the WIV was engaged in military research.<sup>1148</sup>

**ii. WIV Holds Annual Biosecurity Meeting**

On **April 3**, 2019, the Wuhan Institute of Virology (WIV) held its annual work conference on lab security and safety.<sup>1149</sup> Comments from the WIV leadership focused on ensuring sound biosafety practices in advance of key political anniversaries in 2019. The Deputy Secretary of the Party Committee, Secretary of Commission for Discipline Inspection He Changcai

**emphasized the strict implementation of the requirements of the safety management responsibility system** to ‘be responsible to the party and government, a single post has dual responsibilities [to the party and government], joint control and shared management [between the party and government], [and] holding those accountable for dereliction of duties’, **and insist on the ‘imperative to manage safety while managing professional work, and the imperative to manage safety while managing production,’** it is imperative that both aspects of the work advance side by side.<sup>1150</sup>

He Changcai further called for WIV managers to:

strictly abide by the system of various national laws as well as the rules and regulations of the CAS and the WIV on safety management, strengthen day-to-day safety management, and at unscheduled times, **launch self-inspections of safety [conditions] and rectification of hidden dangers...**<sup>1151</sup>

Wang Yanyi, the director of the WIV, also delivered remarks, opening with the assertion that “the safety work of the institute is the precondition and guarantee for succeeding at all of the other work at the institute.”<sup>1152</sup> He continued with the theme of holding researchers accountable for safety incidents, demanding that, “all operations inside the laboratory must be carried out in strict adherence to professional standards and procedures with no tolerance for any kind of wishful thinking and that steps must be taken, to strengthen safety management for students.”<sup>1153</sup> Wang closed by admonishing: “[s]afety work is no trivial matter...[w]hen you discover problems, promptly rectify them in a satisfactory manner.”<sup>1154</sup>

### iii. WIV Submits 13 Biosafety Patents in One Month

In 2019, the WIV submitted 17 patents related to biosafety. Thirteen of these 17 patents would be submitted between **April 22 and 25**, 2019. They covered a range of improvements for physical containment (hermetically sealed doors), wastewater treatment, decontamination (autoclaves and chemical showers), and maintaining negative air pressure in the high-containment laboratories (exhaust air management). These patents are noteworthy because they reflect ongoing efforts to maintain and improve the WIV’s biosafety posture, particularly of the new campus that had been in operation for a little over two years.

One patent filed on April 22, 2019 addressed the problem of maintaining airtight seals on gas-tight doors and cites the potential problem of an existing door assembly that developed slow leaks over

time. The patent did not specify whether the problem of potential leaks resulted in any escape of pathogenic microorganisms. A second related patent submitted the same day in April is entitled “automatic air-compensating type airtight door” and describes:

[t]he sealing strip on the back of the door closed by the airtight door is inflated and expanded to be in a closed state for a long time, the air path can slowly release air in actual use, the pressure in the sealing strip of the door is insufficient, the expansion sealing performance is reduced and the adjacent rooms are in “communicat[ion].

The requirement for airtight construction is only applicable to BSL-4 laboratories, as well as the equivalent level animal BSL-4 laboratories. It is not a strict requirement for BSL-3 laboratories. Containment in BSL-3 laboratories “is predicated on maintaining a negative air pressure gradient between the uncontrolled outer areas and the inner laboratories, with those areas of highest hazard having the most negative air pressure.”<sup>1155</sup>

On April 24, 2019, WIV researchers submitted a patent entitled: “Biological safety laboratory exhaust systems.”<sup>1156</sup> As described, the patent is for a manually operated auxiliary exhaust fan to maintain negative pressure and improve disinfection of biosecurity laboratories HEPA filters. The manually operated exhaust fan specifically addressed the “phenomenon of positive environmental pressure [that] is very easy to occur in the process of fan failure and backup switching.”<sup>1157</sup> According to the patent, the manually operated exhaust fan also improved sterilization of the WIV’s ventilation shafts and improved disinfectant penetration of HEPA filter units.<sup>1158</sup>

A third example demonstrates the WIV trying to address issues associated with biosafety autoclave sterilizers. The patent titled “Biosafety autoclave and sterilization method,” was also submitted on April 22, 2019. It indicated WIV researchers encountered problems with autoclaves being used in their high-containment laboratories. They cited problems such as not being able to achieve required sterilization temperatures; potential leaks around the autoclave doors and excessive condensation and moisture of autoclaved infectious materials. The patent highlighted several design and process related improvements. These included additional internal temperature sensors, improved autoclave door seals, and maintaining the exhaust gas port open to vent excess steam and humidity during the sterilization process.<sup>1159</sup>

#### iv. WIV holds Annual State Secrets Training,

Xiao Gengfu, the CCP Party Secretary at the WIV, required all of its professional research personnel, postdoc researchers, and graduate students to attend a training session on **May 10, 2019**. The session was devoted to the protection of state secrets. All attendees were required to sign pledges to protect classified information pertaining to research at the WIV.<sup>1160,1161</sup> Tang Kaihong, a local official from China’s National Administration for the Protection of State Secrets, discussed the national security risks involved with the institute’s research and warned of infiltration efforts by foreign spies, according to an account published by the WIV’s parent organization, the CAS.<sup>1162</sup> The WIV also published its own

report<sup>21</sup> on the training dated May 13, 2019.<sup>1163</sup> The importance of protecting state secrets also featured as a key subject of the basic training that the new class of graduate students at the WIV received on September 3, 2019.<sup>1164</sup>

#### v. Director of WIV BSL-4 Lab Drafts Paper on Biosafety Challenges

On **May 15, 2019** five days after the state secrets training, Yuan Zhiming, the WIV director of the Wuhan National Biosafety Laboratory (BSL-4) and Wuhan CAS branch director thus making him a senior political WIV leader, submitted an article for publication in the English language *Journal of Biosafety and Biosecurity* where he serves as one of two editors-in-chief.<sup>1165</sup> The paper was titled “Current Status and Future Challenges of High-Level Biosafety Laboratories in China.”<sup>1166</sup> Published in the September 2019 edition of *the Journal of Biosafety and Biosecurity*, Zhiming described the biosafety challenges confronting China and the WIV.<sup>1167</sup> He detailed deficiencies in training, funding, and proper maintenance and upkeep of high-containment laboratory equipment and facilities, particularly BSL-3 laboratories:

[W]e have encountered some challenges; there are insufficient laboratories in industry and in clinical units, an unbalanced distribution of regions and associations, a lack of proper national coordination and resource sharing management, as well as an uncertainty about the financial support for laboratory construction, operation, and maintenance. These bottlenecks hamper the capacity of well-established laboratories to quickly respond to public health emergencies....

...[E]nforcement [of regulations] still needs to be strengthened. Furthermore, due to different investment sources, affiliations, and management systems, the implementation of these laboratories faces difficulties converging objectives and cooperation workflows. This scenario puts laboratory biosafety at risk since the implementation efficiency and timely operations are relatively compromised....

...[M]aintenance cost is generally neglected; several high-level BSLs have insufficient operational funds for routine yet vital processes. Due to the limited resources, **some BSL-3 laboratories run on extremely minimal operational costs or in some cases none at all**....

...Currently, **most laboratories lack specialized biosafety managers and engineers**. In such facilities, some of the skilled staff are composed of part-time researchers. This makes it difficult to identify and mitigate potential safety hazards in facility and equipment operation early enough. Nonetheless, biosafety awareness, professional knowledge, and

---

<sup>21</sup> While the WIV report was dated May 13, the webpage URL and the time stamp from Google search results both indicated that the report was not posted until November 11, 2019, which as the report documents later, was concurrent with when the WIV was dealing with the fallout from a major security incident.



operational skill training still need to be improved among laboratory personnel.<sup>1168</sup>

#### **b. Biosafety Concerns June to August 2019**

During the summer of 2019, the tone and content of internal WIV reports shifts. Previously internal reports pressed WIV researchers to increase the pace of scientific advancement and domestic innovation while reminding them of the importance of biosafety and biosecurity. From June to August 2019 these internal reports show a similar level of focus on solving the “stranglehold” problem and achieving scientific breakthroughs as past reports. However, the internal reports prepared during this time period express much more concrete “foundational problems” and “shortcomings” regarding biosafety and biosecurity lapses at the WIV.

As one report during this time period noted, WIV researchers must “personally strengthen their awareness of unexpected risks, to prevent and control the risks of [the spread of infectious disease] at all times.” Multiple reports stress the need to mitigate risk through better supervision with middle management at the WIV coming under criticism for unidentified shortcomings related to biosafety. During this period, WIV researchers also continued to draft academic articles related to biosafety and biosecurity and the importance of training. Lastly, the WIV issues procurement notices including for the air disinfection system at its new BSL-4 laboratory suggesting that the WIV was still working to get the facility operating smoothly.

#### **i. Communist Party Leaders Urge “Leapfrog Development” and Focus on “Stranglehold” Challenges**

On **June 10**, 2019, Xiang Shuilun, a CCP official from Hubei province, was sent to the WIV to examine its efforts to expand the party’s presence within the institute.<sup>1169</sup> This may be routine but it is consistent with proposed legislation placing the party at the forefront of high-containment laboratory operations and security. He also praised the WIV for its efforts:

[t]o address the ‘stranglehold’ problem of importing key and core equipment, [your team] organized a specialized working group to carry out technological [efforts] to tackle the problem, and to procure and develop domestically produced substitutes.<sup>1170</sup>

On **June 20**, 2019 the WIV held the first of three study sessions on Xi Jinping’s admonition to CCP members to “*stay true to our original aspiration and keep firmly in mind our mission.*”<sup>1171</sup> Xiao Gengfu, the Secretary of the WIV’s CCP Committee, urged WIV personnel to:

Focus on the ‘stranglehold’ problem within the realm of biosafety, put forward plans to resolve the problem, and by tackling this thorny problem, overcoming the challenges, and earnestly pushing forward the construction and development of the Center for Biosafety Mega-Science,

[we can] help the development of science and technology for the nation.<sup>1172</sup>

On **June 24**, 2019, the WIV held the second study session.<sup>1173</sup> A senior CCP official warned about the precariousness of the WIV's development:

Currently, the work of planning and establishing the Center for Biosafety Mega-Science [at the WIV] is at a critical stage, this not only requires the vast majority of management personnel to continuously raise their outlook, quality, and capabilities to complete the work of shouldering responsibility, leading the troops well, and implementation, but also requires full coordination between each department, [and] from this [we can] do a better job of escorting the convoy of science and technology innovation work.<sup>1174</sup>

On **June 27**, 2019, the Communist Party Branch of the WIV's new Zhengdian Campus, where the BSL-4 laboratory is located, was named a "Red Flag Party Branch," in part for its accomplishments in overcoming the "stranglehold problem."<sup>1175</sup>

## ii. WIV Leaders Discuss and Correct "Shortcomings" & "Foundational Problems"

On **July 8**, 2019, Xiao Gengfu, the CCP Secretary at the WIV, led a meeting with WIV management to discuss problems with the facilities and operations at the new BSL-4 laboratory. The meeting participants were reported as having "had an animated discussion focused on addressing current shortcomings and foundational problems that exist in the construction, operational, and maintenance processes of the P4 [BSL-4] laboratory."<sup>1176</sup> Xiao Gengfu summarized the discussion:

Members of the group of party leaders went through a deep investigation and study, and a wide-ranging [process] of soliciting opinions, in order to fully understand and recognize the shortcomings and foundational [problems] limiting the institute's development and raised measures that were targeted and could be operationalized to resolve [those problems].<sup>1177</sup>

Xiao Gengfu concluded by noting that:

[B]uilding the Institute's Center for Biosafety Mega-Science not only requires research staff to personally strengthen their awareness of unexpected risks, to prevent and control the risks of [the spread of infectious disease] at all times, but also requires the management personnel for research support departments to raise the quality and increase the effectiveness of their work and earnestly serve the institute's development of science and technology innovation.<sup>1178</sup>

### iii. WIV Holds Additional Biosafety and Biosecurity Meetings

Echoing reports in June, a report of a WIV internal meeting on **July 17, 2019**, referenced the need to improve biosafety training and management at the WIV:

The party members in attendance expressed their views and recommendations targeted at **improving biosafety theory and biosafety technological training, and the system for screening and managing hidden safety dangers**, as well as the sharing of high-precision instruments, the overall [process] of moving to the Zhengdian laboratory, and other issues.<sup>1179</sup>

Two additional reports published on **July 19, 2019** reiterated concerns about the quality of WIV's professional management. On **July 25, 2019** the Wuhan Institute of Virology held a meeting attended by senior WIV leadership<sup>1180</sup> where Xiao Gengfu, the Secretary General of the CCP Committee at the WIV and de facto head of the institute, used the July 25, 2019 meeting to reiterate Secretary General Xi's remarks:

[T]hat safeguarding state security is matter of paramount importance. In order to uphold state security in the key areas of politics, economics, and society, we must maintain a high level of vigilance from the beginning to the end.<sup>1181,1182</sup>

Xiao Gengfu further stressed that the WIV should work on risk reduction:

[W]e must enhance our ability to neutralize risks, going past appearances to look at the root, doing all we can do to neutralize risks at the source, [and] prevent the transmission, layering, evolution, and escalation of various risks...<sup>1183</sup>

Xiao Gengfu's comments suggested morale issues among WIV personnel. After conducting an inspection in which he held roundtable discussions, personal interviews with individual researchers, and received formal reports from lab managers, Xiao:

[P]ointed out that the development of the P4 [BSL-4] laboratory needs to place importance on a harmonious culture. We must strengthen organized coordination inside the laboratory... [and] go the next step to strengthen the sense of belonging among our institute's personnel in order to make the P4 laboratory exert a greater effect in establishing the Center for Biosafety Mega-Science.<sup>1184</sup>

Wang Yanyi, the director of the WIV, also noted unspecified “urgent” problems facing the WIV and repeated Xiao Gengfu’s theme from earlier in July that core responsibilities were not being taken seriously enough:

**[We must] prioritize solving the urgent problems we are currently facing,** and regarding the next phase of work, conduct deployments and make arrangements to ensure that responsibilities are fully implemented, and work measures are completed to promote the stable and sustainable development of the institute.<sup>1185</sup>

Tong Xiao, party secretary and deputy director of the BSL-4 lab, delivered a presentation titled “Safe Operations and Coordinated Development of the P4 Laboratory,” in which he:

“[F]ocused on the ‘stranglehold’ problem, meeting the requirements of the state... conducted a deep analysis of the major problems currently existing in the P4 [BSL-4] laboratory and major lines of thinking about how to solve them from the perspective of the hardware and technological aspects of the laboratory facilities, the management of biosafety, the institute’s coordinated development, incentives and awards for personnel, etc”.<sup>1186</sup>

On **July 31**, 2019, the WIV issued its third procurement notice of the year related to renovation or maintenance of systems in its laboratory facilities. In this case, the WIV solicited contractors to renovate the hazardous waste treatment system at the BSL-4 lab on the Zhengdian Park campus, which had been in operation for less than two years. The budget was reportedly US\$1.5 million.<sup>1187</sup>

According to experts interviewed as part of this investigation, the WIV’s wastewater system was unique. Rather than accumulate liquid and physical hazardous materials in a centralized tank that would be batch heated, chemically sterilized and then disposed of, the WIV had a continuous system. The unidirectional flow system is where hazardous waste is heated to greater than 121 °C and treated through an effluent pipeline. As noted in several 2019 patent submissions, either the batch or continuous approach to wastewater decontamination can be problematic. As described, if either approach is insufficient to render the liquid sterile, there is a biosafety risk with the effluent.<sup>1188</sup> The WIV encountered problems maintaining temperatures to ensure sterilization and the accumulation of mineral and other particulates (scaling) inside the effluent pipes and the heating element in the system.<sup>1189</sup> The scaling problem resulted in blockage of the effluent pipeline.<sup>1190</sup>

#### **iv. WIV Repairs Air Disinfection System**

On **August 14**, 2019, the WIV issued its fourth procurement notice of the year for a project involving its environmental air disinfection system and scalable automated sample storage management system. The procurement order was issued by the original Xiaohongshan WIV campus. The budget for the project was approximately US \$1.3 million.<sup>1191</sup> A gaseous (vaporized hydrogen peroxide) disinfection

system was procured for the original Xiaohongshan WIV campus. A gaseous hydrogen peroxide disinfection system is an effective, less corrosive means to sterilize a laboratory conducting infectious agent research.<sup>1192</sup>

The reference to a scalable automated sample storage management system is a key element of sample integrity. Sample integrity contributes to improved experiment reproducibility. This system is used when large numbers of biospecimen are handled. Automated handling and storage are the method of choice to maintain and improve sample integrity.<sup>1193</sup>

#### v. WIV Discuss “Rectification and Reform” of “Critical Problems

On **August 23**, 2019, Xiao Gengfu, the Secretary General of the CCP Committee at the WIV, called a meeting of party officials, party members, and mid-level management at the WIV in which he delivered a report titled, “Identifying the Disparities, Stressing Implementation, [and] Diligently Pioneering Biosafety Technological Innovation.”<sup>1194</sup> Xiao’s report focused on, among other things, “critical problems impacting the development of the research institute and hot topics of concern among personnel.”<sup>1195</sup>

An investigation conducted by Xiao Gengfu produced a “detailed list of problems” consisting of “a total of 20 problems and five aspects” in which the WIV’s work was inadequate.<sup>1196</sup> The WIV report did not describe what those 20 problems consisted of, but his comments suggest the problems were serious:

Regarding those problems that could be immediately corrected as soon as they were identified, we earnestly launched specialized rectification, clarified the division of duties, applied pressure to implement responsibilities [at all levels], and held the institute’s leadership and related departments accountable for completing their assigned responsibilities before the deadline. **For problems that need sustained rectification, [we must] place importance on top-level design, specifying [responsibilities] at every level... by means of precise organization, making careful arrangements [and] concerted efforts, [and] in the spirit of hammering the nail, [we must] accelerate [efforts] to push forward with various specialized rectification projects, ensuring that the reform is complete and thorough.**<sup>1197</sup>

Xiao Gengfu concluded by:

[E]mphasizing that this... has been a baptism in political ideology, and also a ‘comprehensive testing experience’ for the institute. By going through the implementation of sustained rectification of critical problems that are restricting the institute’s development, we firmly believe that the Wuhan Institute of Virology has the confidence [and] the capability to

succeed at establishing a high-level biosafety laboratory and to safeguard and manage [our] work.<sup>1198</sup>

#### **vi. Papers on Risks of Synthetic Biology and Chinese Regulatory Gaps**

As noted previously, on **August 6**, 2019 Yuan Zhiming, the director of the Wuhan National Biosafety Laboratory (BSL-4), submitted an article for the September 2019 edition of the *Journal of Biosafety and Biosecurity*, which he started earlier the same year.<sup>1199</sup> This was Yuan's third published article on biosafety in 2019. It focused specifically on the risks presented by the rapidly growing field of synthetic biology, particularly gene editing. The article highlighted the critical role of screened and trained personnel:

Biosecurity in synthetic biology is largely dependent on the trusted workforce in the laboratory, and therefore a great deal of attention must be paid to a culture of safety, as well as careful personnel recruitment, background screenings, and adherence to strict policies and procedures regarding laboratory access.<sup>1200</sup>

#### **c. Inflection Point: September 2019**

During September 2019, this investigation identified several what appear to be actions by PRC government entities, including the WIV and local Wuhan government authorities that are consistent with awareness of a possible release of a novel coronavirus. At the local government level these actions appear to be mostly preparatory and precautionary. For example, Wuhan's international airport conducted an emergency response drill premised on an arriving passenger being infected with a novel coronavirus. The Wuhan municipal government issued a public health directive that emphasized the importance "on-the-spot investigations" of infectious disease outbreaks. This investigation also found Chinese language reporting indicating that, in February 2020, PRC officials conducting retrospective case searches for early previously undetected COVID-19 cases examined case records dating back to September 2019.

While government agencies appeared to be taking preparatory actions, the WIV appeared to be taking actions in response to some past event. On September 11, 2019, an investigation into the political reliability of the Chinese Academy of Sciences, of which the WIV is an important component, was launched by the CCP's leading political investigations unit. The next day, the WIV removed its virus database from the internet. At the time it was the largest viral database in Asia and had a password protected section housing unpublished viruses, including at least 100 novel SARS-related coronaviruses. WIV procurements issued during September include a tender for a large-scale renovation of the HVAC system at its new Zhengdian campus. The WIV also issued a procurement notice for increased campus security.

#### **i. Wuhan Government Issues Healthcare Directive**

On **September 5**, 2019, the General Office of the Wuhan Municipal People's Government drafted a public health preparedness memo titled "Notice Regarding the Issuance of the Implementation

Plan for Reforming and Improving the Comprehensive Supervision System of the Medical and Health Industries in Wuhan.”<sup>1201</sup> The directive was released to relevant government departments on **September 17, 2019** but not publicly disclosed until seven months later on April 21, 2020.<sup>1202</sup>

While the directive was wide-ranging in its content, its dominant concern was “deepening the supervision and regulation of public health services” by the government and CCP.<sup>1203</sup> The directive specifically identified regulating laboratory safety and monitoring for the outbreak of infectious disease in a list of priority areas.<sup>1204</sup> It called for measures to ensure infectious diseases were being reported to the authorities<sup>1205</sup> and required preparations for sudden outbreaks, “strengthen on-the-spot investigations of the development of capabilities and quality of public health services in public health departments in public hospitals.”<sup>1206</sup>

## ii. CCP Launches Political Inspection of the WIV’s Parent Organization

On **September 11, 2019**, the CCP Central Committee dispatched the No. 15 Inspection Patrol Group to the Beijing headquarters of the Chinese Academy of Sciences (CAS), the parent organization of the WIV, to conduct an investigation into its leadership.<sup>1207</sup> The investigation of CAS was scheduled to last for approximately two months. The areas of focus were described as “violations of political discipline, party organizational discipline, [financial] ethics discipline, discipline with regard to the masses, work discipline, and discipline in one’s personal life...”<sup>1208</sup> The loyalty of CAS to CCP leadership was a persistent theme and the investigation was intended to “search deeply for political deviation.”<sup>1209</sup> It is not known what specific activities may have prompted this investigation.

An indication of the seriousness of the investigation is the fact that the No. 15 Inspection Patrol Group findings were presented to the CCP’s most senior decision-making body, the Politburo Standing Committee.<sup>1210</sup> A general summary of the findings posted on the website of the CCP Central Discipline Inspection Commission articulated 15 “principal problems” that were discovered during the inspection, a sample of which included:

1. a “persistent gap” between Xi Jinping’s important instructions on pursuing “leapfrog development in science and technology” and CAS’s implementation of Xi’s instructions,
2. “unsatisfactory [efforts] to implement the strengthening of the Party’s comprehensive leadership demands,”
3. “weak links in the work to manage and supervise [CAS] scholars,”
4. “the continued existence of formalistic and bureaucratic ways of doing things, and violations of the spirit of the Central Committee’s 8-Point Decision on Improving Party and Government Conduct,” and
5. “Insufficient insistence on political standards in making personnel decisions.”<sup>1211</sup>

The summary of the investigation admonished the CAS to “take further steps to manage and supervise personnel decisions with regards to scholars.”<sup>1212</sup>

While it is unclear if the two events were related, the WIV held a meeting attended by more than 50 of its personnel and management on September 3, 2019, eight days before the political inspection of CAS began. The WIV meeting was convened to discuss the beginning of internal audits and to “warn” personnel about violations of CCP discipline. The internal report of the meeting indicated that those in attendance studied nine cases of CAS personnel who had violated various aspects of the CCP disciplinary policies.<sup>1213</sup>

### iii. WIV Takes Down Online Database of Viruses

On **September 12**, 2019, apparently between the hours of 2:00 and 3:00 AM local time,<sup>1214</sup> the WIV took down its online depository of data on viral sequences called the Wildlife-Borne Viral Pathogen Database.<sup>1215</sup> This database was previously accessible to researchers around the globe with the exception of a password protection section, which held unpublished sequence data accessible only to WIV personnel.<sup>1216,1217</sup> Records indicate an initial period of inactivity with the database between August 16-22, 2019, with a period of normal accessibility and activity restored from August 23 to September 12, 2019 when the database was taken offline for a prolonged period of time.<sup>1218</sup> Public access has never been restored.

It does appear that the database was briefly accessible, but only intermittently, from December 2019 to February 2020.<sup>1219</sup> February 2020 is when claims began to circulate on the Chinese internet alleging that the WIV was the origin of SARS-CoV-2 outbreak.<sup>1220</sup> The database has been completely inaccessible since those claims began circulating. The database reportedly contained more than 2,000 entries consisting of sample and pathogen data, including full and partial genomic sequences, collected from bats and mice. The WIV had reportedly collected more than 15,000 samples from bats, from which they had identified over 1,400 bat viruses.<sup>1221,1222</sup> The disabled database reportedly held an estimated 100 unpublished sequences of bat beta-coronaviruses – the genre of coronaviruses to which SARS-CoV-2 belongs.<sup>1223</sup>

### iv. WIV Strengthens Physical Security and Issues HVAC Renovation Tender

On **September 12**, 2019, the same day that the WIV took the Wildlife-Borne Viral Pathogen Database offline in the early morning hours, the WIV issued a notice on a PRC government procurement website seeking to procure unspecified physical “security services” for its facilities at the Zhengdian Park campus where the BSL-4 lab is located. The budget was US\$1,281,022.

Four days later, on **September 16**, 2019, the WIV issued a notice on a PRC government procurement website seeking consultation for a “central air conditioning renovation project.” The approximately U.S. \$500M renovation project at the WIV Zhengdian campus was estimated to take 210 days.<sup>1224</sup> Air handling and conditioning plays a “critical role” in the control of hazards in a biocontainment facility.<sup>1225</sup> As described in US technical manuals “[a]ir supply and air exhaust systems are essential to maintain proper air flows and pressures.”<sup>1226</sup> Maintaining air balances at a negative pressure in animal rooms, for example, less than in other parts of the laboratory and less than in the surrounding corridors is essential. Standard practice has the highest hazardous area in a laboratory maintain at least a minimum 0.5-inch water pressure from that the rest of the building.<sup>1227</sup>



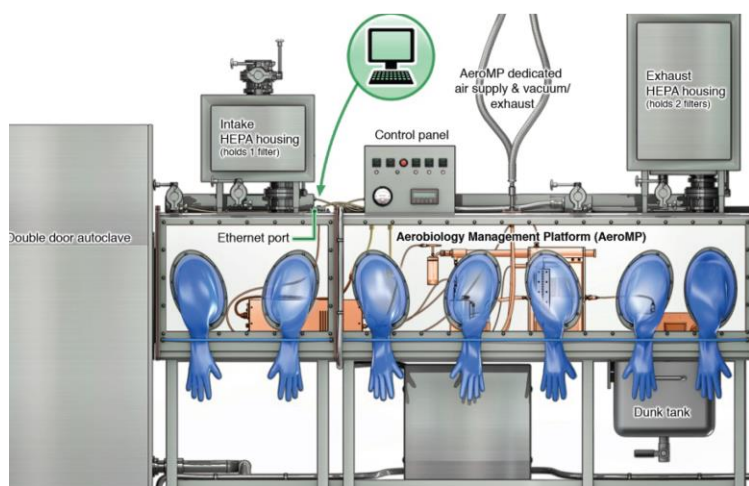

Figure 55. Graphic depiction of Biosafety Cabinet Level 3. Source: Lackemeyer, M. G., Kok-Mercado, F.d, Wada, J., Bollinger, L., Kindrachuk, J., Wahl-Jensen, V., Kuhn, J. H., & Jahrling, P. B. (2014). ABSL-4 aerobiology biosafety and technology at the NIH/NIAID integrated research facility at Fort Detrick. *Viruses*, 6(1), 137–150. <https://doi.org/10.3390/v6010137>

Air disinfection is an essential feature of any high-containment laboratory. The use of biosafety cabinets and a High-Efficiency Particulate Air (HEPA) filtration system limits pathogen exposure of researchers, the laboratory and the surrounding environment. Two features provide a high degree of protection. First, negative pressure is maintained inside the biosafety cabinets and laboratory. The pressure gradient being more negative in the cabinet than the laboratory. Second, both incoming and exhaust air into and from the biosafety cabinet and laboratory are subject to HEPA filtration. Exhaust air is HEPA filtered at least twice.

The current state of high-containment practice has air HEPA filtered once going into the cabinet. It is HEPA filtered twice through serial filters before being discharged into the facilities air exhaust system. The facility ventilation system filters the exhaust gas through additional HEPA filters before it is discharged into the environment. HEPA filters are typically tested after gas decontamination to certify they are non-infectious. They are also tested for leaks and certified at least annually.<sup>1228</sup>

#### v. WIV Advises Wuhan Airport Drill on Responding to “Novel Coronavirus”

On **September 18**, 2019, the Wuhan Municipal Customs Administration and other officials held two “emergency response drill activities” at the Wuhan Tianhe International Airport in preparation for Wuhan’s hosting of the Military World Games in October. One exercise involved the discovery of high-level radiation in a piece of luggage, and the second focused on responding to the outbreak of a novel coronavirus at the airport.<sup>1229</sup> State-run media reported: “the drill simulated .... the whole process of handling the discovery of one case of a novel coronavirus infection at the airport customs lane, we drilled an epidemiological investigation, medical examination, real-time set up of a quarantine area, isolation and testing, the transfer of cases [to hospitals], hygiene management, and other stages.”<sup>1230</sup>

The relevance of this drill to the origins of the COVID-19 pandemic is hard to assess, but the timing of the drill, less than three months before the start of the outbreak of coronavirus pandemic, necessitates its inclusion in this report. The decision to base the drill, in part, on the discovery of a novel coronavirus could simply reflect the research bias of the WIV personnel assisting with the exercise. The WIV's involvement is consistent with a report that the WIV signed a "strategic cooperation agreement" with the Wuhan Municipal Customs Administration in June 2019.

A previous drill was held at the Wuhan Tianhe International Airport in November 2014, and Ebola was the scenario in question.<sup>1231</sup> That drill was likely prompted by the Ebola outbreak in West Africa reported by the WHO in March 2014.<sup>1232</sup> While other airports in China have held safety drills in advance of their cities' hosting of major international events, it appears that only Wuhan has specifically drilled for a "novel coronavirus" as a scenario.<sup>1233</sup> Notably the safety drills performed in Beijing before the 2008 Olympics, and in Shanghai before the 2010 World Expo, did not focus on a potential coronavirus outbreak, even though the SARS crisis of 2003-2004 was still a recent memory.<sup>1234</sup>

#### d. Emergence: October- November 2019

**Introduction:** Description of temporal events around the early emergence of COVID-19 was provided in Chapter 2.

##### *Summary of Evidence of Emergence in October-November 2019\**

- Epidemiological & Molecular dating Modeling Suggests Early-October to Mid-November 2019 Emergence.
- Abnormal Increase of ILI Influenza Negative Cases: Potential Early Indicator of COVID Spread.
- U.S. Consulate Reports “Bad” Flu Season.
- Wuhan Hosts Military World Games, Athletes Report Illness.
- Hospital Traffic & Online Searches for COVID-19 Symptoms Spike.
- Spike in Lab Test Negative Influenza-Like Illness (ILI) in Wuhan in mid-November 2019.
- China Launches COVID-19 Vaccine Program.
- Rumors of New Virus Spread in Wuhan, Doctors See Influx of Patients.
- Wuhan University Biostatistics Professor Identifies Cases with Symptom onset in mid-November 2019.
- Unpublished PRC Government Data Lists COVID-19 Cases in Mid-November, including Earliest Known Potential Index Case.
- English Teacher Falls Ill in late-November and Develops Pneumonia, Later Confirmed as COVID-19.

\* For full description of events see Chapter 2

#### i. November 12, 2019 WIV BSL-4 Communist Part Branch Report

On November 12, 2019, CCP members of the WIV’s BSL-4 laboratory reposted an article that was a description of the high pathogen research performed by their branch.<sup>1235</sup> The original article was published on August 30, 2019 on the CAS Science website. There were substantive differences between the two versions suggesting that there were either edits in the first version or additions to the later November post.

The August story cites their collective efforts to meet the strategic goals of Xi Jinping for science with research at the WIV BSL-4. It described the technical challenges they encountered in constructing the laboratory. The post explicitly referenced the “three no’s” the researchers confronted in establishing their laboratory: “no equipment and technology standards, no design and construction teams, and no experience operating or maintaining” a high-containment laboratory.<sup>1236</sup> The story stated they overcame these challenges. They also described the risks of such work likening opening test tubes of pathogenic viruses with opening Pandora’s box.<sup>1237</sup>

The November 2019 version posted on the WIV internal website differs in several ways. Unlike the August CAS version, the November version explicitly mentions the risk of potential laboratory leaks and infections and possible past biosafety incidents involving “high pathogen microorganisms.”<sup>1238</sup> In addition to the reference of Pandora’s box, the November article describes that once test tubes are opened, these viruses “come without a shadow and leave without a trace.” The text further describes “although [they] have various protective measures, it is nevertheless necessary for lab personnel to take the greatest care to avoid danger caused by operational errors.” The later post also described that “every time this has happened” the BSL-4 Party members would immediately respond.<sup>1239</sup>

The November post also affirms the laboratory’s status as the first BSL-4 in China with the most advanced protective equipment and highest level of biosafety. It also describes the nature of the BSL-4 design and unique construction. It specifically notes that the French design conforms to China’s architectural requirements. It describes efforts to ensure the laboratory was airtight including laser welding the steel walls rather than using traditional sealants and conducting multiple airtightness tests. It also notes the “indigenous design” of negative pressure controls. The additional descriptive language used in the November post implies the possibility of some kind of incident for which the BSL-4 CCP researchers sought to distance themselves from possible implication.

**ii. November 15, 2019 Chutian Metropolis Daily Article on the Institute of Model Animals of Wuhan University**

On November 15, 2019 a local Wuhan newspaper, Chutian Metropolis Daily, published an article featuring the research conducted at the Institute of Animal Models at Wuhan University. The Chutian Daily is an official local publication jointly supervised by the Propaganda Department of the Hubei Provincial Committee of the Chinese Communist Party and the Information Office of the Hubei Provincial People's Government.<sup>1240</sup> The article described the current capabilities of the Institute providing experimental animals for a range of medical research principally cardiometabolic diseases. It also cited historical testing of prototype SARS vaccines in rhesus monkeys in its ABSL-3 laboratory.

According to the article, the ABSL-3 laboratory was renovated in 2015. The story implied the laboratory was inactive and “currently awaiting the final process of re-approval.”<sup>1241</sup> The story is contradicted by the fact that the Institute’s last published SARS research was submitted in August 2017 and published in March 2018. Funded by a grant awarded in 2016, the Institute performed SARS vaccine challenge studies in rhesus monkeys vaccinated with an inactivated SARS vaccine to evaluate the risks of antibody dependent enhancement.<sup>1242</sup>

The story also noted that *Nature*, an “international authoritative journal,” published a “feature article” introducing the Institute of Model Animals of Wuhan University. *Nature* did publish an Advertisement Feature on November 7, 2019 paid for by the Partnership & Custom Media Unit of Nature Research for the Institute of Model Animals of Wuhan University.<sup>1243</sup> The advertisement highlighted the Institute’s basic and translational research on cardiometabolic diseases without mentioning its previous or recent SARS-related vaccine or any infectious disease related research. In order to have published this advertisement on November 7, 2019, the advertisement order would have had to been submitted not later than October 30th.

Further, a government announcement in May 2020 indicated that the Director of the Institute, Li Hongliang, was dismissed from his position on May 6, 2020. As described, he also resigned his post as Dean of the Wuhan University rather than being dismissed. The grounds for his resignation were not specified.<sup>1244</sup>

### iii. November 19, 2019: Senior CAS Safety and Security Official Visits WIV

On **November 19**, 2019, Dr. Ji Changzheng, the Director of the CAS Office of Technology Safety and Security, was dispatched from Beijing to the WIV to personally oversee and administer a one-day senior level safety training seminar.<sup>1245</sup> At this session, he addressed various senior personnel from the CAS Wuhan Branch as well as WIV research department heads, and other “responsible personnel” from all WIV departments.<sup>1246</sup> This was the first identified or recorded visit by this official to the WIV.



Figure 56. Ji Changzheng addressing senior leaders & managers of the Wuhan Academy of Science & Institute of Virology on November 19, 2019

According to this report posted on WIV’s internal website, Ji opened the training by conveying “important oral and written instructions” directly from Xi Jinping regarding a “complex and grave

situation.” Ji’s reference to “**important written instructions**” is a direct reference to an internal CCP system of written directives called *pishi*. *Pishi* are issued when a senior CCP leader receives a printed report on a specific issue, important development, or worrisome trend. The senior official then handwrites instructions on the report to be conveyed to the lower-level officials who are responsible for the subject of the report.<sup>1247,1248</sup> From the context, the report that Xi Jinping received likely dealt with “**safety and security work**” at the WIV.

Ji Changzheng relayed instructions and demands from the CCP Central Committee and State Council regarding safety and security work and focused on **imparting the important oral remarks and written instructions regarding safety and security work from General Secretary Xi Jinping and Premier Li Keqiang**. At the same time, [Ji] linked [the instructions] to many large-scale cases of domestic and foreign safety incidents in recent years, and from the perspective of shouldering responsibility, standardizing operations, emergency planning, and inspecting hidden dangers one-by-one, [he] laid out a deep analysis, with many layers and taken from many angles, which vividly revealed the complex and grave situation currently facing safety work. Finally, Ji Changzheng focused on the actual situation at CAS with a summary and analysis of laboratory safety, technology security, student safety, campus security, and Internet security among other common problems that exist in its security and safety management work.<sup>1249</sup>

Ji’s remarks were followed by the WIV’s Deputy Director of the Office of Safety and Security, Hu Qian, who “summarized several general problems that were found over the course of the last year during safety and security investigations, and [he] pointed to the severe consequences that could result from hidden safety dangers and stressed that the rectification of hidden safety risks must be thorough, and management standards must be maintained.”<sup>1250</sup>

#### **iv. November 19, 2019: Short Suspense Procurement for Air Incinerator**

The WIV issued a sole source, short suspense procurement request for an air incinerator at the original WIV Xiaohongshan campus.<sup>1251</sup> The procurement stated that the incinerator was needed to sterilize exhaust gas from an autoclave. The procurement described the current autoclave system as having a double HEPA filter assembly. The incinerator would be added to the exhaust pipe outside the autoclave to incinerate all the media discharged.<sup>1252</sup> This procurement suggests that the WIV’s autoclave at its campus in central Wuhan was not completely sterilizing infectious contents and/or the autoclave HEPA filters were not sufficiently sanitizing infectious exhaust gases.

#### **v. November 20-22, 2019: Remedial WIV Biosafety & Biosecurity Training**

Immediately following the November 19, 2019 session, Ji Changzheng led a separate two and a half day “Training on Biosecurity Laboratory Management and Techniques for Conducting Experiments.” The training involved more than 150 WIV participants as well as personnel from BSL 1-3 labs at other research institutes in Wuhan.<sup>1253</sup> Zhao Chihong, the Director of Laboratory Management at the China

CDC, joined Ji to lead the training.<sup>1254</sup> “The content of the [training] course included the national biosecurity law, regulations, and standards, the management system for high-containment biosecurity laboratories, methods for assessing biosafety risks in laboratories, the storage of bacterial and viral strains, and the management of waste from animal experiments and laboratories,” according to the WIV website.<sup>1255</sup>

**2019-11-20**

08:30-08:40 Opening Ceremony  
 08:40-10:00 Chinese Academy of Sciences Science and Technology Security Early Warning & Monitoring System Construction  
 10:10-10:30 Group photo/break  
 10:30-12:00 Standardized management of pathogenic microorganism laboratory  
 14:00-15:30 Biosafety Overview  
 15:30-15:40 Recess  
 15:40-17:10 Establishment of Biosafety Laboratory Management System

**2019-11-21**

08:30-10:00 Collection, transportation, preservation and exchange of bacteria and viruses  
 10:00-10:10 Recess  
 10:10-11:40 Biosafety critical equipment and laboratory waste disposal  
 14:00-15:30 Animal Laboratory Biosafety Management  
 15:30-15:40 Recess  
 15:40-17:10 Laboratory safety operation technology and norms

**2019-11-22**

08:00-09:30 Protection level and facilities of biosafety laboratory  
 09:30-09:40 Recess  
 09:40-11:10 Risk assessment and safety of unknown pathogen detection  
 11:10-12:10 Written Examination  
 13:00- Students return

Figure 57. Translation of Biosafety Experimental Management and Experimental Technology Training Course Flier Conducted at the Wuhan Institute of Virology November 20-22, 2019.

**vi. December 5, 2019: WIV visit by Hubei Vice Governor**

According to the Hubei Daily, Vice Governor Xiao Juhua visited the WIV to “inspect” the BSL-4 laboratory. “Juhua conducted a site investigation of the course of its construction, its current research, direction of development, etc. and immediately called a meeting [of lab management] to carry out support measures on site.”

***Summary of Evidence SARS-CoV-2 was Spreading in December 2019\****

- Serological Studies on Pre-Pandemic Samples Indicate SARS-CoV-2 Circulating Internationally in November and December 2019.
- Wuhan Closes Schools Because of Outbreak in November-December 2019
- Chinese social media Begins to See an Increase in Requests for Help for Medical Treatments in Wuhan starting December 20, 2019.
- Prefecture in Western Hubei Province Orders Live Animal Farms Shutdown on December 23, 2019.
- Clinicians Report Clusters of Unknown Pneumonias with link to Huanan Seafood Market to Wuhan Public Health Authorities Starting December 26, 2019
- On **January 1, 2020**, Wuhan authorities shut down the city’s Huanan Seafood Wholesale Market

\* For full description of events see Chapter 2

## Chapter 10: Coronavirus & Infectious Disease Research at the WIV

### Introduction & Overview of WIV Coronavirus Research Process

The WIV is a preeminent virus research institute in China and is a hub for coronavirus research centered in Wuhan. Unsurprisingly, given the 2003-2004 SARS epidemic, viruses – specifically bat SARS-related coronaviruses – were a major focus of the WIV research. As part of their mission, WIV researchers looked for coronaviruses that could infect humans and animal hosts studying the evolution of these viruses. Using advanced techniques, they simulated recombination events and genetically modified viruses to predict future evolution. As a result, the WIV researchers created novel chimeric viruses capable of infecting human cells. In short, SARS-CoV-2 would be the kind of virus the WIV would want to find or artificially synthesize. The last step of virus identification and manipulation included research to identify medical countermeasures against viruses that posed potential human harm.

The SARS epidemic resulted in a dramatic shift and emphasis in virology research priorities. Prior to SARS, coronaviruses were only known to cause mild cold-like illness in humans. They were of comparatively low concern to infectious disease experts, with limited scientific interest, and constrained research funding compared to influenza. When SARS first infected humans, scientists were shocked that bat coronaviruses could jump species into humans, achieve human-to-human transmission, and kill ~10% of those infected. This was particularly true in China where SARS emerged and had the greatest impact.<sup>1256</sup> Identification of the causative agent of SARS, the intermediate host (palm civets) and then the natural reservoir (bats) was a reactive research process that took years.

The scientific approach, determining the causative infectious disease agent by an unknown microorganism such as SARS, is known as Koch's postulates. These postulates require meeting four criteria: 1) the organism must always be present in every case of the disease; 2) the organism must be isolated from a host containing the disease and grown in pure culture; 3) samples of the organism taken from pure culture must cause the same disease when inoculated into a healthy, susceptible animal in the laboratory; and 4) the organism must be isolated from the inoculated animal and must be identified to be the same original organism first isolated from the original diseased host.<sup>1257</sup>

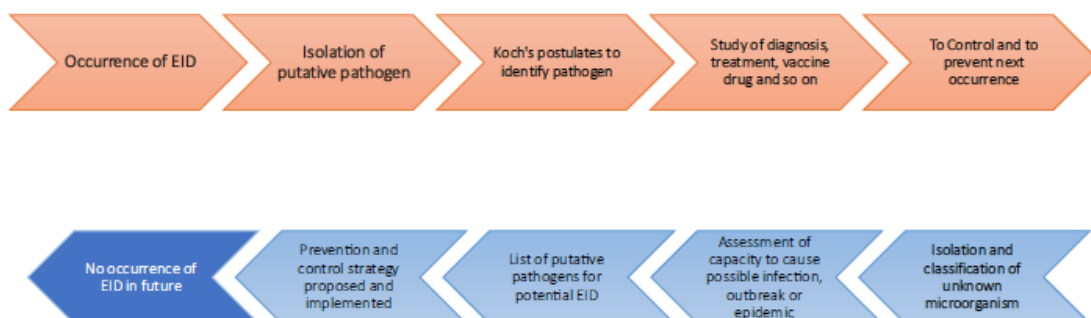

Figure 58. Top depicts Traditional Microbial Etiology compared to Koch's Postulates. Bottom depicts 'Reverse Microbial Etiology. Source: Xu J. (2019). Reverse microbial etiology: A research field for predicting and preventing emerging infectious diseases (EID) caused by an unknown microorganism. *Journal of Biosafety and Biosecurity*, 1(1), 19–21. <https://doi.org/10.1016/j.jobb.2018.12.005>



Following Koch's postulates establishes causation only after an outbreak has occurred. In light of potential future pandemic risks, China's scientific and policy community decided to take a more proactive course identifying potential pandemic pathogens before they could cause an outbreak. 'Reverse microbial etiology' is such a defined approach for emerging disease prevention.<sup>1258</sup> The 'reverse' approach conducts proactive investigations discovering and assessing potential human pathogens. The process intends to recover such pathogens from nature, isolate, classify and characterize them. The pathogens would be evaluated for their pathogenicity including infection experiments on cell lines, tissues and laboratory animals, and genetic analysis to identify virulent gene sequences.<sup>1259</sup> Such was the approach subscribed by the WIV and other Wuhan research institutes and public health agencies.

Bats were already associated with highly pathogenic human diseases and were known to harbor a significantly higher proportion of zoonotic viruses than other mammals.<sup>1260</sup> Some of the more well-known bat viruses, including Rabies (lyssavirus), Nipah and Hendra viruses (henipaviruses), and Marburg, Ebola, and Mengla viruses (filoviruses), posed a significant risk to human health.<sup>1261,1262</sup> For the WIV, after the initial SARS outbreak, bats became a major focus of their research efforts.

## **1. Field Expeditions and Sample Collection**

The principal objective of the WIV's coronavirus research was to identify potential human pandemic causing SARS-related viruses and develop medical countermeasures against them. In pursuit of this task, researchers collected hundreds of SARS-related coronaviruses from across China and Southeast Asia during annual sampling expeditions. As a consequence of these expeditions, by 2019 the WIV had collected, at a minimum, approximately 20,000 bat and other animal samples from across China.<sup>1263</sup> This estimate is likely only a partial sum of the total number of samples collected, the actual total number of samples is likely higher.

The WIV had reportedly collected more than 15,000 samples from bats alone, from which they had identified over 1,400 bat viruses.<sup>1264</sup> The WIV's formerly public database reportedly contained more than 2,000 entries consisting of sample and pathogen data, including full and partial genomic sequences, collected from bats and mice. The database also reportedly held an estimated 100 unpublished sequences of the beta-coronavirus subgenus to which SARS-CoV-2 belongs.<sup>1265</sup>

The risk of research-related incidents leading to human infections begins with field expeditions where WIV researchers and collaborators first collect bat samples. The researchers operate in a challenging setting with limited light and sometimes only with partial personal protective equipment exposing skin to injury or hazardous exposures. Capturing bats and collecting blood, urine and fecal samples risks exposure to potentially infectious materials. It also places researchers at high risk for potential bites, scratches and needle-stick injuries while handling bats and collecting samples. Typically, in laboratory settings animals are sedated before they are handled and samples collected.<sup>1266</sup> In the wild, sedating bats caught in traps itself risks being bit or scratched.

## **2. Screening Viral Samples and Genetic Manipulation**

After collection, samples were transported back to Wuhan, technicians and researchers would then follow a process of detecting, isolating, and sequencing SARS-related bat viruses from these samples. Samples underwent initial evaluation in BSL-2 settings where they were first evaluated for the presence of a characteristic beta coronavirus gene, the RdRp. If the RdRp gene was present, researchers then attempted to isolate and sequence the virus.<sup>1267</sup> The full-length viruses would then have been grown in a variety of cell cultures, including human types, to assess the ability to infect cells. Viruses that could infect human cells would then have been assessed for pathogenicity in humanized mice or susceptible intermediate hosts such as palm civets.<sup>1268</sup> Finally, researchers evaluated existing medical countermeasures against these newly discovered SARS-related viruses.

If researchers failed to recover a full-length sequence of a coronavirus of interest, they sometimes spliced viral genetic fragments onto the backbone of a SARS-related virus that could already grow in cell culture. Beginning not later than 2017, WIV researchers performed gain-of-function related experiments to evaluate the pandemic potential of otherwise non-viable viral fragments. To do this, researchers spliced different novel coronaviruses' spike protein or the spike's receptor-binding-domain (RBD) onto already characterized viable coronaviruses.<sup>1269</sup> The resulting chimeric viruses, which contained genetic material from both the novel and the well characterized coronaviruses, would then be evaluated for its infectivity and pathogenicity in human cells and humanized mice.

The initial isolation, characterization, and cell propagation of SARS-related bat coronaviruses should be performed under BSL-3 conditions.<sup>1270</sup> Creating chimeric SARS-related coronaviruses with the intent that the resulting virus can infect human lung cell culture or humanized mice should be conducted in BSL-3 level conditions or above. SARS-related coronaviruses are "Risk Group 3 viruses".<sup>1271</sup> National Institute of Health guidelines, from April 2019, recommended that:

Experiments involving the introduction of recombinant or synthetic nucleic acid molecules into Risk Group 3 agents will usually be conducted at BSL-3 containment. Experiments with such agents will usually be conducted with whole animals at B[S]L3 or B[S]L3-N [enhanced] containment.<sup>1272</sup>

For example, virus cultivation done as part of experiments in 2015 at the University of Texas Medical Branch taking the spike protein from SARS-related coronavirus strain SHC014 and inserting it onto the backbone of SARS strain WIV1. This experiment was performed at an enhanced BSL-3 level "[b]ecause of the ability of chimeric SHC014 viruses to replicate in human airway cultures, cause pathogenesis *in vivo* and escape current therapeutics."<sup>1273</sup>

WIV scientists also conducted similar coronavirus research creating chimeric SARS-related viruses able to infect human cells. One doctoral candidate, Zhang Lei Ping, described in detail the process of "rescuing" coronaviruses that were difficult to isolate, adapt and grow in a laboratory in his 2017 dissertation.<sup>1274</sup> The publication described techniques to manipulate distinct coronaviruses, combining genetic components to create a new, or recombinant, virus. This was intended to simulate natural recombination events that occur in nature.

Lei Ping noted that his techniques combined the “advantages of two mainstream coronavirus reverse genetics methods, established a new efficient and cost-effective method, and successfully constructed a reverse genetics system for bat SARS-related coronaviruses.”<sup>1275</sup> In contrast with the U.S. studies, Lei Ping indicated that “[t]he proliferation and cell infection experiments of live [SARS-related] virus (including recombinant viruses) were performed in [Shi’s] BSL-2... laboratory in compliance with [WIV] biosafety regulations.”<sup>1276</sup>

In November 2017, Lei Ping published another paper, based on his dissertation, describing the rescue of coronaviruses with spike proteins able to efficiently bind to human cells in a manner distinct from previously identified SARS or MERS viruses.<sup>1277</sup> This is a trait shared with SARS-CoV-2.<sup>1278</sup> These and like publications from the WIV demonstrate the growing proficiency of its researchers in established and novel genetic techniques that can rescue non-viable viruses. Lei Ping’s research also noted that combination of these techniques did not leave any signs of genetic manipulation.<sup>1279</sup>

In a written interview provided to *Science* and published July 31, 2020, Shi Zhengli confirmed that at least some of the WIV’s coronavirus research continued to be done in BSL-2 conditions. Only after the outbreak of COVID-19 did lab safety guidelines in China require coronavirus research to be conducted at minimum of BSL-3 conditions.<sup>1280</sup> Dr. Shi’s statements align with Lei Ping’s dissertation, WIV researchers worked with live recombinant SARS-related viruses in BSL-2 laboratories.<sup>1281</sup>

Until the COVID-19 pandemic, researchers at the WIV were working in inappropriately low biosafety levels with SARS-related coronaviruses. One goal of this research was to deliberately make those viruses more capable of infecting human cells. In the two years leading up to the pandemic, publications from the WIV’s researchers attest to increasingly sophisticated coronavirus experiments, using humanized mice, bats, pangolins, and palm civets.<sup>1282, 1283</sup>

### **3. WIV Coronavirus Research 2017-2020**

Insights concerning the nature of WIV related coronavirus research are derived from several sources. These include annual reports submitted by EcoHealth Alliance to the NIH, EcoHealth Alliance and WIV grants and grant applications. Further insights were gained from published scientific literature by the WIV and interviews of key WIV personalities such as Shi Zhengli.

#### **a. NIH-NIAID Grant: Understanding Risk of Bat Coronavirus Emergence**

##### **i. Year 4 Progress Report**

On April 13, 2018, EcoHealth Alliance submitted its annual progress report for year 4 of its NIAID funded grant project titled “Understanding the Risk of Bat Coronavirus Emergence.” This progress report detailed accomplishments and activities funded by the grant from June 2017 to May 2018. The report noted that serological surveys of residents in Yunnan province found that 7 (~2.8%) individuals tested positive for SARS-related coronavirus antibodies. “[O]ur serological testing results provide the first evidence ever of a bat SARS-CoV [related viruses] spilling over into people in the wild.

All the SARS-CoV-2 positive individuals were from Yunnan Province. These findings... also highlight this region [Yunnan] as a hotspot for SARS-CoV-2 future spillover risk.”

Another major accomplishment detailed in the Year 4 progress report was the results of humanized mice experiments conducted by the WIV sometime between June 2017 and May 2018. WIV scientists inserted the spike proteins of three SARS-related viruses, SHC014, WIV16, and Rs4231 into a SARS-CoV backbone. A fourth SARS-related virus, WIV1, was also used. Transgenic (humanized) mice that expressed hACE2 were infected with chimeric viruses in a two weeklong experiment. Within 4 days of being infected, “the viral load in lung tissues of mice challenged” with strains SHC014, WIV16, and Rs4231 “reached more than  $10^6$  genome copies/g and were significantly higher than that in” the WIV1 strain.

SARS-related viral strain SHC014, in addition to being highly infectious in humanized mice, also showed evidence of significant pathogenesis. “Mice challenged with [SHC014] have experienced about 20% body weight loss by the sixth day post infection.”<sup>1284</sup> At the end of the 2 week observation, 75% of the SHC014 mice died compared to 25% and 50% for the other infected cohorts. This result is indicative of severe disease in mice infected with SHC014. The data presented in the progress report showed viral load and weight-change data through 14 days post-infection. In sum, humanized mice infected with SHC014 experienced severe weight loss within 4 days of being infected and significantly higher mortality than the other chimeric viruses.<sup>1285</sup>

EcoHealth and the WIV were particularly interested in the results of the SHC014 humanized mice infection results because the spike protein of SHC014 is around 10% divergent from the spike protein of SARS-CoV.<sup>1286</sup> Another coronavirus, HKU3 has a spike protein that is approximately 25% divergent from SARS-CoV and does not use hACE2. The high viral growth and loss of weight in humanized mice infected with SHC014 suggested that SARS-related coronaviruses with a spike that is between 10-25% divergent from SARS-CoV may retain the ability to bind to hACE2 while being sufficiently different from SARS-CoV-1 to render SARS-CoV-1 medical countermeasures ineffective. Finding and experimenting on SARS-related viruses with a spike protein that was 10-25% divergent from SARS-CoV’s spike protein would be a major focus of EcoHealth Alliance and the WIV’s NIAID funded research.

The Year 4 Progress Report also included a Bat Coronavirus Host-Virus Phylo-geography. EcoHealth used available coronavirus sequences (RdRp) collected between 2008 and 2015 (a total of 326 BetaCoV’s). The sequences reflected not only those collected with their existing NIAID funding, but those collected under their prior NIAID grant and from funding from Chinese government agencies. The study also included 206 Chinese Beta-CoVs sequences available in GenBank. The data was visualized to reconstruct the ancestral location of these viruses. The analysis permitted identification of geographic areas in China and northern Laos that were likely sources of origin and diversity of these viruses.

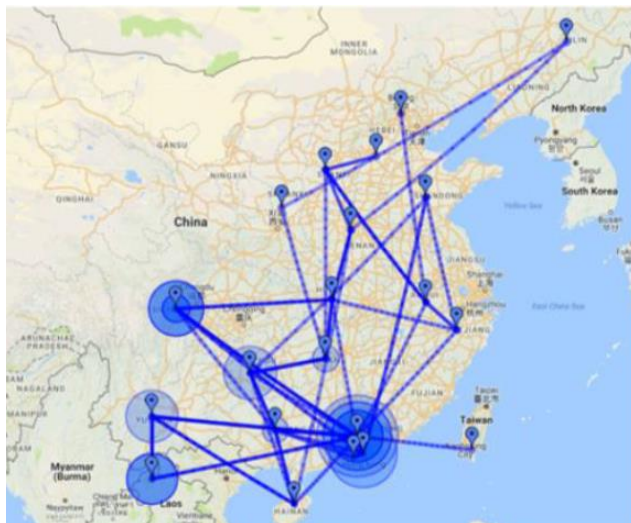

Figure 59. Ancestral location reconstruction for Beta-CoVs. The bigger the circle is, the more ancestral the corresponding node is. Source: Understanding the Risk of Bat Coronavirus Emergence: NIAID Grant 5R01A110964-05 Year Four Report Submitted 09/16/2020

## ii. 2019 Grant Renewal Application

On November 5, 2018, EcoHealth Alliance submitted a renewal application to NIAID for its “Understanding the Risk of Bat Coronavirus Emergence” grant project. The renewal would fund the project through June 2025. As with the original term of the project, the WIV was a sub-recipient of funding with money allocated by EcoHealth Alliance. Building off of the humanized mice experiment conducted in 2017-2018, one of the overarching goals of the project, was to test “our hypothesis that [SARS-related coronaviruses] with 10-25% divergence in the [Spike] protein sequences from SARS-CoV are **likely able to infect human cells, and evade [monoclonal antibody] therapeutics and vaccines**” (emphasis in original). A second goal was to “map the geographic distribution of their bat hosts, and other ecological risk factors to **identify the key ‘hotspots’ of risk for future spillover**” (emphasis in original). To meet these goals, the project was divided into three groups of experiments or “aims”.

EcoHealth and its collaborators planned to “conduct targeted bat sampling at sites where we predict that undiscovered high risk [SARS-related coronaviruses] strains exist. Bat sampling will be targeted geographically and by host species to test predictions about evolutionary diversity” of SARS-related coronaviruses. After sampling and screening for SARS-related coronaviruses, researchers planned to “analyze RdRp and S [spike] protein sequences” of recovered viruses or viral fragments to determine “their capacity for spillover to people.”

The fieldwork and laboratory work necessary to complete Aim 1 would be led by scientists from the WIV and the East China Normal University.<sup>1287</sup> Bat sampling expeditions would be conducted in Yunnan, Guangxi, Guangdong, and Guizhou Provinces in southern China.<sup>1288</sup> There is no indication that they planned to conduct sampling expeditions in Hubei Province. Researchers intended to “sample at least 5,000 bats from these four provinces” over the 5-year duration of the grant.<sup>1289</sup> Collected samples would be taken to the WIV for screening, isolation, sequencing, and analysis. EcoHealth anticipated collecting between 100 to 200 novel SARS-related viruses during this project.<sup>1290</sup>

Once the viruses were taken to the WIV, the spike protein of “all novel” SARS-related virus strains would be sequenced.<sup>1291</sup> Spike proteins that show the potential to infect humans and other animals, thus at high-risk of cross-species spillover were “of particular interest” to researchers.<sup>1292</sup> Given the expected volume of samples and large number of SARS-related viruses, WIV scientists would prioritize “high-risk” viruses, which had the following spike protein traits:

- i) Diverges from SARS-CoV’s spike by between 10-25%;
- ii) Have RBDs that could use human/bat receptors;
- iii) Have recombinant chimeric spike [proteins] indicative of gene flow between clade I and II strains; and
- iv) Have bat ACE2 receptors that might select for spike [protein] RBDs that can use human receptors for entry.<sup>1293</sup>

In simple terms, EcoHealth and the WIV were looking for SARS-related viruses who had spike proteins that could infect humans using ACE2 receptors, but whose spike proteins were 10-25% different from SARS-CoV. They were also interested in viruses that had spike proteins that straddled the divide between clade I SARS-related viruses that use ACE2 receptors and clade II SARS-related viruses that do not use ACE2. For example, SCH014 and RaTG-13 are clade I and clade II beta coronaviruses respectively.<sup>1294</sup>

Aim 2 of the grant renewal was to better understand the mechanisms of SARS-related virus spillover including routes of exposure to people. “We will conduct focused, targeted human surveys and sampling to identify key risk factors for SARSr-CoV spillover and evidence of illness. To maximize our opportunity of capturing human exposure to bat CoVs, we will conduct community-based surveillance in regions with high SARSr-CoV prevalence and diversity.” These surveys were conducted in the Southern Chinese provinces of Yunnan, Guangdong, and Guangxi. These areas were identified by EcoHealth Alliance and the WIV as most likely locations for bat SARS-related virus spillovers to humans.

Aim 3 was to take the over 125 SARS-related viruses the WIV and EcoHealth expected to find during the sampling expeditions and conduct experiments on the subset of viruses determined to be at “high spillover risk and evasion of immune therapeutic and vaccine efficacy.” Specifically, they proposed:

We will use [spike] protein sequences to select a range of viral strains that cover the 10-25% [spike] protein divergence we predict as high public health potential and construct chimeric [SARS-related] viruses using the WIV1 backbone and these S genes...We will rescue of full-length clones and assess infection of non-permissive cells expressing human, bat and civet ACE2 receptors, Vero cells, primary human airway epithelial cells... We will conduct experimental infections in hACE2 transgenic mice to assess pathogenicity and clinical signs. Finally, using a panel of mAbs [monoclonal antibodies] that neutralize SARS-CoV infection *in vitro* and *in vivo*, and vaccine against SARS-CoV [spike] protein, we will examine the capacity of strains with divergent [spike] protein sequences to evade therapeutics, revealing strains with high public health potential... Using these results, and data from Aims 1 and 2, we will use spatial modeling techniques to identify geographic hotspots in southern China where bat species that harbor high risk

[SARS-related] viruses inhabit, where communities that have high exposure to bats exist, where serological or PCR evidence of spillover has been identified, and where underlying demographic or environmental trends suggest high risk of future emergence. (*Internal citations omitted*)

The experiments proposed in the grant renewal appear to be procedurally identical to the humanized mice experiments done in 2017-2018 at the WIV.

The experiments in the renewal application all of which were to be done at the WIV were going to last 14 days with the mice “monitored daily for weight loss, morbidity, and clinical signs of disease.” Select humanized mice would be euthanized at 2-, 4-, and 6-days post-infection for analysis. The experiments were to be done in a BSL-3 laboratory. The only major difference between the experiments in the renewal application and the experiments done in 2017-2018 is that the renewal’s humanized mice were to be infected with new chimeric bat SAR-related viruses with different spike proteins collected during the grant project, instead of existing SARS-related viruses. The creation of chimeric SARS-related viruses was also to be done at the WIV.

### **iii. Delayed Year 5 Progress Report and Termination of WIV’s Participation**

The year five progress report was due to NIAID and NIH in September 2019. According to NIH, it did not receive the Year-5 progress report until August 2021, almost two years later. The exact circumstances surrounding the submission of the year five progress report are a matter of dispute between NIH and EcoHealth. EcoHealth claims that it attempted to submit the Year-5 progress report in July 2019, but was unable to because NIH had approved the grant’s renewal which caused the NIH grant’s portal to reject the Year-5 progress report. EcoHealth provided this investigation with screenshots and emails to NIH grant management that appear to corroborate its attempts to submit a Year-5 progress report and subsequent rejection.

Substantively the Year-5 progress report, which at 30 pages is around 10 pages shorter than past progress reports, details “continued” infection experiments involving humanized mice and using strains WIV1, WIV16, SHC014, and Rs4231. Unlike in the “preliminary” results from the year 4 progress report, the year 5 progress report provides the result of the experiments:

All of the 4 [SARS-related] viruses caused lethal infection in hACE2 transgenic mice, but the mortality rate varies among 4 groups of infected mice. 14 days post infection, 5 out of 7 mice infected with WIV1 remained alive (71.4%), while only 2 of 8 mice infected with rWIV1-SHC014 S survived (25%). The survival rate of mice infected with rWIV1-WIV16S and rWIV1-4231S were 50%. Viral replication was confirmed by quantitative PCR in spleen, lung, intestine and brain of infected mice. In brain, rWIV1, rWIV1-WIV16S and rWIV1-4231S cannot be detected 2 days or 4 days post infection. However, WIV1-SHC014 was detected at all time points and showed an increasing viral titer after infection. The viral load reached more than  $10^9$  genome copies/g at the dead point.<sup>1295</sup>

As in the experiment report in the Year-4 progress report, SHC014 showed the most viral growth and had the highest mortality with 75% of infected mice dying within 14 days of infection.

In an October 20, 2021, letter to multiple Congressional committees, NIH Deputy Director Dr. Larry Taybak explained that the Year-5 progress report was submitted on August 3, 2021 “in response to NIH’s compliance efforts.” Reference to compliance efforts appears to refer to requests for information from EcoHealth that NIH sought beginning in April and July of 2020. Those efforts appear to have begun on April 19, 2020, when Dr. Michael Lauer, NIH Deputy Director for Extramural Research, emailed EcoHealth Alliance notifying them that due to “allegations that the current crisis was precipitated by the release from WIV of the coronavirus responsible for COVID-19,” the WIV was being suspended from participation in federal programs.

On April 24, 2020, NIH moved to terminate EcoHealth’s grant entirely. However, on July 8, 2020, NIH reinstated the grant, but immediately suspended it. The suspension letter states that the WIV “has been conducting research at its facilities in China that pose serious bio-safety concerns, and, as a result, create health and welfare threats to the public in China, and other countries, including the United States.” The letter continued “[w]e have concerns that WIV has not satisfied safety requirements under the award and that EcoHealth has not satisfied its obligations to monitor the activities of its subrecipient to ensure compliance.” Lifting the suspension was predicated on EcoHealth addressing specific NIH concerns, including:

- Disclose and explain out-of-ordinary restrictions on laboratory facilities, as suggested, for example, by diminished cell-phone traffic in October 2019, and evidence that there may have been roadblocks around the facility from October 14-19, 2019.
- Explain why WIV failed to note that the RaTG-13 virus, the bat-derived coronavirus in its collection with the greatest similarity to SARS-CoV-2, was actually isolated from an abandoned mine where three men died in 2012 with an illness remarkably similar to COVID-19 and explain why this was not followed-up.
- EcoHealth Alliance must arrange for WIV to submit to an outside inspection team charged to review the lab facilities and lab records, with specific attention to addressing the question of whether WIV staff had SARS-CoV-2 in their possession prior to December 2019.

Notably the April and July 2020 correspondence from NIH did not mention that EchoHealth Alliance had not submitted the required Year-5 report even though the failure to do so would constitute grounds for suspension. NIH did ultimately request the then-missing year 5 progress report. EcoHealth’s official response to NIH’s July 8 letter has not been made public, but the organization sharply criticized NIH for suspending the grant in statements to the press.

This investigation was unable to determine what occurred between NIH’s July 8, 2020, letter and August 3, 2021 when EcoHealth successfully, but belatedly submitted its year 5 progress report. It appears that, upon receipt of the year 5 progress report, NIH realized that the humanized mice infection



experiments conducted at the WIV were gain of function experiments, as it was traditionally defined prior to the COVID-19 pandemic.<sup>22</sup> In its October 20, 2021 letter to Congress, NIH claimed that the increased illness in humanized mice “was an unexpected result of the research, as opposed to something the researchers set out to do.” This statement is hard to reconcile with the stated objectives of the grant.

One of the overarching goals of the grant was to understand what characteristics increased the spillover risk of SARS-related coronaviruses. Where a virus collected and isolated by the WIV showed potential to infect humans, WIV researchers conducted infection experiments in human lung tissue cells and humanized mice to better understand the risk it posed. This included taking the spike protein of a potential human infecting coronavirus and inserting it into the backbone of a virus that was already known to infect human cells. Contrary to NIH’s claims, there was no expectation that the resulting artificial (chimeric) virus would be less virulent or transmissible than the naturally occurring backbone virus. In fact, the scientists involved hoped to find SARS-related coronaviruses that were more transmissible and more virulent than SARS, like strain SHC014, and that evaded existing countermeasures.

EcoHealth Alliance objected to the statements in the October 20, 2021, NIH letter to Congress. EcoHealth, in a letter to NIH dated October 26, 2021, contending that there was only one humanized mice infection experiment and that EcoHealth had met its reporting obligations by disclosing the humanized mice experiment in its year 4 progress report. EcoHealth also noted that the information on the experiments provided to it by the WIV was insufficient to determine if there was viral growth. The single experiment, evidently not repeated, was reported over the two annual progress reports because the WIV continued to analyze data from it.

Whether this is an accurate recounting of the WIV’s experiments is not known. The way the experiment’s data is reported gives the impression there were at least two experiments. Despite the

---

<sup>22</sup> On October 19, 2021, one day before it sent the letter notifying Congress about the WIV’s humanized mice infection experiments, NIH’s made substantial changes to the entry on its website where gain of function research involving potential pandemic pathogens was defined by removing the following definition:

“The term gain-of-function (GOF) research describes a type of research that modifies a biological agent so that it confers new or enhanced activity to that agent...The subset of GOF research that is anticipated to enhance the *transmissibility* and/or *virulence* of potential pandemic pathogens, which are likely to make them more dangerous to humans, has been the subject of substantial scrutiny and deliberation. Such GOF approaches can sometimes be justified in laboratories with appropriate biosafety and biosecurity controls to help us understand the fundamental nature of human-pathogen interactions, assess the pandemic potential of emerging infectious agents, and inform public health and preparedness efforts, including surveillance and the development of vaccines and medical countermeasures. This research poses biosafety and biosecurity risks, and these risks must be carefully managed.”

It was replaced by a statement emphasizing the small number of experiments that constitute gain of function research of concern. “On limited occasions, when justified by compelling public health need and conducted in very high biosecurity laboratories, NIH has supported certain research that may be reasonably anticipated to create, transfer or use potential pandemic pathogens resulting from the enhancement of a pathogen’s transmissibility and/or virulence in humans.... While such research is inherently risky and requires strict oversight, the risk of not doing this type of research and not being prepared for the next pandemic is also high. While ePPP [enhanced potential pandemic pathogen] research is a type of so called ‘gain-of-function’ (GOF) research, the vast majority of GOF research does not involve ePPP and falls outside the scope of oversight required for research involving ePPPs.”

apparently inconclusive results of this one-time experiment, the humanized mice experiments featured prominently in EcoHealth's grant renewal application to NIH and in their March 2018 grant application to DARPA. EcoHealth pursued millions of dollars in additional funding by arguing that the humanized mice experiment proved that a SARS-related virus with a spike protein between 10-25% divergent from SARS posed a potential pandemic risk. In order to mitigate that potential risk, EcoHealth and its partners advocated they needed to find or construct such a virus, analyze it and develop countermeasures against it.

Notwithstanding the uncertainties surrounding the humanized mice experiment, the October 26, 2021, EcoHealth letter states that all experimental work was done at the WIV with WIV scientists providing summaries of their research to EcoHealth. EcoHealth's role appears to be limited to inserting those summaries into the annual progress reports sent to NIH and forwarding NIAID funding to the WIV and others. To that end, in late-2021 NIH requested EcoHealth produce "complete and dated copies of the original laboratory notebook entries and of the original electronic files" from the WIV relating to the humanized mice infection experiment. EcoHealth forwarded the request to the WIV because EcoHealth did not have copies of the material. By August 2022, the WIV had yet to produce the requested data, leading NIH to terminate the WIV as a subgrantee.

#### **b. Other WIV International Coronavirus Collaborations**

The Global Virome Project (GVP) is an international, non-governmental project organized in 2016 and launched in January 2018 dedicated to finding new viruses and assessing their potential to cause pandemics. The GVP was launched by EcoHealth Alliance, The One Health Institute at the University of California Davis, the Chinese Centers for Disease Control and Prevention, and Metabiota, a San Francisco based data company focused on predicting disease outbreaks.<sup>1296</sup> It enjoyed financial support from USAID and NIH, as well as scientific funding agencies from other countries. Like the WIV's 'reverse microbial etiology' viral prospecting work, the GVP sought to sequence animal and environmental samples to identify novel viruses, understand their mechanisms of human infection and assess their likelihood of spilling over into humans. An April 2018, U.S. State Department Cable described the WIV's research as "the forerunner to the Global Virome Project."

Chinese researchers were eager collaborators in the GVP. George Fu Gao, the Director of the China CDC from August 2017 to July 2022, expressed to U.S. Embassy officials in Beijing that the GVP was a national priority for China.<sup>1297</sup> The Beijing Genomics Institute, one of the largest sequencing companies in the world, expressed strong support for the GVP and even committed to provide 30% of the sequencing for the Project. The same April 2018 State Department cable noted that the WIV and CCDC "expressed interest" in hosting the GVP's viral database, but that some participating countries were "skeptical on whether China could remain a transparent 'gatekeeper' for this information".<sup>1298</sup>

The GVP was controversial at the time of its launch and remains so today with many scientists questioning the likelihood of success. According to scientist Kristian Anderson, "[w]hat you're trying to predict is likely something that happens maybe once out of tens of billions of encounters, with one virus out of millions of potential viruses. You will lose your fight against the numbers."<sup>1299</sup> Scientists and biosafety experts also questioned the wisdom of actively seeking out potential pandemic pathogens. In a 2018 paper in *Nature* titled "Pandemics: Spend on Surveillance not Prediction" virologists Edward

Holmes, Andrew Rambaut, and Kristian Andersen criticized the GVP on the ground that “broad genomic surveys of animal viruses will ... be of little practical value when it comes to understanding and mitigating the emergence of disease... We urge those working on infectious disease to focus funds and efforts on a much simpler and more cost-effective way to mitigate outbreaks — proactive, real-time surveillance of human populations”.<sup>1300</sup>

Other experts noted the inherent risks in bio-prospecting, characterization, and public cataloguing of novel viruses. Andy Weber, former Assistant Secretary of Defense for Nuclear, Chemical, and Biological Defense in the Obama Administration, said:

Do you really want to be going into these bat caves to collect and then catalogue which ones are most dangerous to humans? After [PREDICT] having done this work for 15 years, I think there’s little to show for it. As the intelligence community concluded, it’s plausible that it actually caused this pandemic, and to me that’s enough. We don’t have to be sure what caused this pandemic to reduce the risk of the next pandemic. It was of zero help in preventing this pandemic or even predicting this pandemic.<sup>1301</sup>

While PREDICT “identified at least 931 novel virus species from 145,000 samples of wildlife, livestock, and humans”<sup>1302</sup> the total number of samples collected by WIV researchers is unknown. WIV researchers received more than \$1 million from PREDICT as subgrantees of EcoHealth Alliance. The total amount of money received by the WIV from PREDICT and other programs has not been disclosed by USAID.<sup>1303</sup> One such project between EcoHealth Alliance and the WIV led Shi Zhengli’s team to theorize that bats could directly infect humans with a SARS-related coronavirus.<sup>1304</sup> No such evidence of such an infection has been shown in practice.

USAID has declined requests for information from Congress and has chosen to litigate FOIA requests rather than provide responsive documents. However, it appears that at least some virus samples collected, screened, and sequenced by the WIV as part of its work with PREDICT may be closely related to SARS-CoV-2. EcoHealth Alliance, U.C. Davis, and Metabiota have not publicly released some viral sequences collected with PREDICT funding. On April 28, 2020, EcoHealth Alliance President Dr. Peter Daszak emailed U.C. Davis and Metabiota colleagues that “[i]t’s extremely important that we don’t have these sequences as part of our PREDICT release...[h]aving them as part of PREDICT will bring [sic] very unwelcome attention to U.C. Davis, PREDICT, and USAID”.<sup>1305</sup> Viral sequences at issue were labeled “China Genbank Sequences.”<sup>1306</sup>

The GVP has the goal of collecting samples from every mammalian and waterbird species in the world and collecting 500,000 animal viruses with zoonotic potential.<sup>1307</sup> A February 2018 paper published in *Science* by the founders and chief leaders of PREDICT estimates that of the millions of undiscovered animal viruses, there are 650,000 to 840,000 with the likely capacity for zoonotic spillover to humans.<sup>1308</sup> By 2019, GVP researchers were able to identify and map areas of China with the greatest likelihood of discovering new viruses. These areas were concentrated in Yunnan and other Southern Chinese Provinces but not Hubei.

PREDICT's M&A team supported the development and strategic design of the Global Virome Project (GVP). We designed a spatial modeling approach to identify priority sites for targeted wildlife sampling at a 10 x 10 km resolution in countries of relevance to the GVP. PREDICT developed specific maps for the Thai National Virome Project (TNVP) and the China Virome Project and presented these at the TNVP launch, as well as in high-level meetings with Chinese Government and US Embassy leaders in Beijing. These analyses will form the basis for the design of specific workplans in both countries during the rollout of their virome projects in 2019-20.

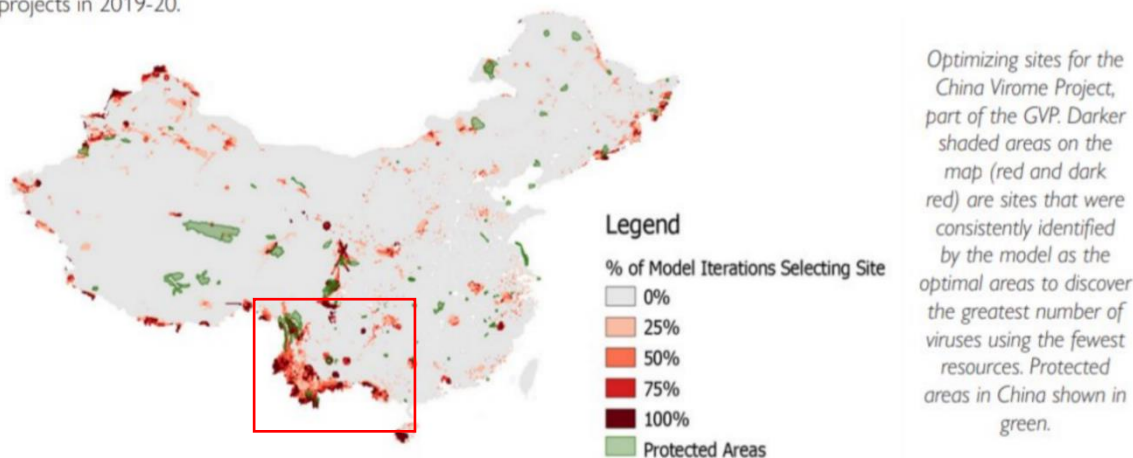

Figure 60. USAID graphic depiction of Global Viral Project as it relates to viral sampling in China

It appears that GVP viral sampling, screening, and sequencing activities in China were undertaken almost exclusively by Chinese researchers with western virologists having only limited access to samples or raw data. For example, based on emails exchanged between U.S. based administrators of PREDICT, as of April 2020, virus samples collected with PREDICT funding in Thailand and China appear to have not been uploaded to PREDICT's viral database.<sup>1309</sup>

Parallel to its involvement in the GVP, China created the China National Virome Project (CNVP) to operate within the PRC. It appears to have received funding and started work in 2016-2017. Of note, a team of researchers primarily based out of Beijing on a CNVP funded virus sampling expedition from May to October 2019 in Yunnan Province China discovered the SARS-related coronaviruses RmYN02, which is 93.3% in its total genome identical to SARS-CoV-2, and RpYN06, which is 94.5% identical.<sup>1310</sup> The scope and scale of the CNVP is unclear.

### c. WIV Funding from PRC Government Agencies

As a state-run institution, the WIV presumably receives the bulk of its funding from its parent organization, the Chinese Academy of Sciences (CAS). A portion of the WIV's budget is provided by grants from PRC government agencies. By reviewing disclosures on U.S. government grant applications and other information from other sources, this investigation found that from 2006 to 2019 the WIV received grants through multiple research programs funded by the National Science Foundation of China, the Chinese Academy of Sciences and the Ministry of Science and Technology. There are likely other grants received by WIV researchers from PRC government agencies that this investigation did not locate.

This investigation was unable to find detailed information about the kind of research conducted directly pursuant to PRC government grants except where researchers disclose in western academic publications that their work was supported by a PRC government agency grant. This kind of disclosure appears to be rare. Since the start of the pandemic, information regarding these grant projects has been removed from the internet. Nevertheless, the titles of the grant programs and description of their objectives provide some idea of the kind of research being funded. In many respects, grants received by the WIV from PRC government agencies appear to substantially overlap with U.S. government grants:

**Table: 7. National Science Foundation of China Grants to WIV**

<b>Grant Title</b>	<b>Duration</b>	<b>Objectives</b>
<b>Interspecies Transmission Mechanism of Zoonotic Viruses</b>	Jan. 2006 – Dec. 2010	<ul style="list-style-type: none"> <li>• Specific objectives unknown.</li> <li>• Academic articles supported with grant funds included examination of difference in receptor usage between SARS and other SARS-related viruses.</li> </ul>
<b>Rapid and High Throughput Diagnostic Methods for Emerging Infectious Viral Pathogens</b>	Jan. 2009 – Dec. 2010	<ul style="list-style-type: none"> <li>• Specific objectives unknown.</li> <li>• No published academic papers identified.</li> </ul>
<b>Metagenomic Analysis of Bat Intestinal Viruses</b>	January 2010 – December 2012	<ul style="list-style-type: none"> <li>• Specific objectives unknown.</li> <li>• Academic articles supported with grant funds reported results of bat sample collection, the establishment of a bat kidney cell line, and virus isolation and analysis.</li> </ul>
<b>Mechanism of Interspecies Transmission of Zoonotic Viruses</b>	January 2011 – December 2015	
<b>Discovery, Isolation, and Identification, Distribution Characteristics, Genetic Evolution and Pathogenicity to Humans of Human Pathogens in Bats</b>	January 2013 – December 2017	<ul style="list-style-type: none"> <li>• Discover, isolate, and name new micro-organisms.</li> <li>• Evaluate the potential pathogenicity or public health significance of newly discovered micro-organisms.</li> <li>• Research technologies, methods, measures, and strategies, for detection, diagnosis, treatment, prevention, and control.</li> </ul>
<b>The Molecular Mechanisms of Virus-Host Interaction</b>	January 2017 – December 2019	
<b>Novel Pathogen Detection Technology for SARS or MERS-like Emerging Infectious Diseases</b>	January 2017 – December 2019	<ul style="list-style-type: none"> <li>• International Cooperation Project to develop a next generation sequencing platform to survey all known SARS-related viruses in China’s bat population.</li> <li>• Develop serological tests that detect all major groups of coronaviruses.</li> <li>• Establish genetically engineered cell lines dedicated for virus isolation.</li> </ul>
<b>Study on the Interferon Response of SARS-related Coronavirus Infected Bat</b>	January 2018 – December 2021	<ul style="list-style-type: none"> <li>• Study interferon induced responses by bat cells infected with SARS-related viruses.</li> </ul>

<b>Cells</b>		<ul style="list-style-type: none"> <li>• Mimic early SARS-related virus infections in bat and human lung cells and late infections in bat and mouse immune system cells.</li> </ul>
<b>Study on the Evolutionary Mechanism of Bat SARS-related coronavirus Adapted to Host Receptor Molecules and the Risk of Cross Species Infection</b>	January 2018 – December 2021	<ul style="list-style-type: none"> <li>• Target SARS-related viral strains which use ACE2 receptors.</li> <li>• Investigate binding ability between the spike protein RBD and ACE2 of different origins.</li> <li>• Test infectivity of SARS-related viruses' different spike proteins through binding affinity tests and reverse-genetic infectious clones.</li> </ul>
<b>Pathogenicity of Two New Bat SARS-related Coronaviruses to Transgenic Mice Expressing Human ACE2</b>	January 2019 – December 2021	<ul style="list-style-type: none"> <li>• Grant project reserved for younger researchers</li> </ul>
<b>Bat Virology</b>	January 2019 – December 2021	<ul style="list-style-type: none"> <li>• Grant project reserved for younger researchers</li> </ul>

#### Chinese Academy of Sciences Grants to WIV

<b>Grant Title</b>	<b>Duration</b>	<b>Objectives</b>
<b>Genetic Evolution and Transmission Mechanism of Important Bat-Borne Viruses</b>	January 2018 – June 2023	<ul style="list-style-type: none"> <li>• “Strategic Priority Research Program”</li> </ul>
<b>Pathogen Host Adaption and Immune Intervention</b>		<ul style="list-style-type: none"> <li>• A “Special Project” with five sub-projects, Project 1 to be conducted at WIV.</li> <li>• Track emerging infectious diseases in reservoir host to understand spatiotemporal and geographic distribution and evolution.</li> <li>• In patients and animals with unexplained disease, identify unknown pathogen and potential pandemic risk.</li> <li>• Study viruses' ability to invade different host cells.</li> <li>• Study pathogen host interactions in viruses that show high levels of pathogenicity and/or transmissibility.</li> </ul>

#### d. Proposed WIV Coronavirus Research: EcoHealth Alliance Project DEFUSE

On March 27, 2018, EcoHealth Alliance submitted a grant proposal titled “Project DEFUSE: Defusing the Threat of Bat-borne Coronaviruses” to the Defense Advanced Research Projects Agency (DARPA). The two major goals of Project DEFUSE were to “identify and model spillover risk of novel SARS-related coronaviruses in Asia” and to design strategies to boost bat immune systems so that they fight infections of SARS-related coronaviruses as a means of reducing overall spillover risk. The immune boost strategy included “targeting high-risk SARSr[related]-CoVs.” EcoHealth was to serve as the lead organization for the project with researchers from the WIV, Duke-National University of Singapore

Medical School, University of North Carolina, U.S. Geological Service's National Wildlife Health Center, and the Palo Alto Research Center participating in the project.<sup>1311</sup>

As part of Project DEFUSE, WIV researchers would intensively sample bats at sites deemed as high zoonotic spillover risk, including “a complete inventory of bats and their SARS-related viruses at our intervention test site in Yunnan, China that harbors bats with high-risk [SARS-related] viruses.”<sup>1312</sup> In total, the project planned to sample around 10,000 bats which were expected to yield approximately 400 to 900 SARS-related viral strains based on EcoHealth's historic sampling experience.

Similar to previous sampling expeditions, bat samples containing coronaviruses from these field expeditions would be analyzed for their spike proteins at the WIV. Viral spike proteins recovered would be sequenced and reverse engineered onto backbone viruses. The backbone viruses were three SARS-related clade I viruses, WIV1, WIV16, and SHC014 all recovered from the Yunnan cave discovered in 2017 by WIV researchers that contain the “building blocks of SARS-CoV.”<sup>1313</sup> All three viruses are closely related to SARS-CoV and use ACE2 entry receptors. In early 2018, WIV researchers inserted the spike proteins of the 3 viruses onto a SARS-CoV backbone and found that WIV1 and SHC014 “cause SARS-related illness in humanized mice (mice expressing human ACE2) with clinical signs that are not mitigated by SARS-CoV monoclonal antibody therapy or vaccination.” In short, WIV1 and SHC014 had shown the potential to infect humans and cause illness that could not be treated with existing SARS therapeutics and vaccines.

The viral growth experiments involving WIV1 and SHC014 were proof of concept for the experiments proposed in Project DEFUSE. Viruses rescued by WIV researchers in DEFUSE would be cultured, characterized, and evaluated in cell cultures, including human lung cells, to demonstrate affinity for human ACE2 receptors, i.e., their capacity to infect humans. Those viruses with human affinity would then be tested in humanized mice to evaluate their potential to infect humans and their potential pathogenicity. These experiments were to be done in BSL-3 laboratories at the WIV.

DEFUSE researchers were interested in finding SARS-related viruses with specific features they correctly believed increased a virus's pandemic potential. One feature was a proteolytic cleavage site:

We will analyze all SARSr[elated]-CoVs' [spike protein] sequences for appropriately conserved proteolytic cleavage sites in [the] S2 [subunit] and for the presence of potential furin cleavage sites. SARSr[elated]-CoV [Spike proteins] with mismatches in proteolytic cleavage sites can be activated by exogenous trypsin or cathepsin L. Where clear mismatches occur, we will introduce appropriate human specific cleavage sites and evaluate growth potential in Vero cells and HAE [human lung cells] cultures.... We will also review deep sequence data for low abundant high risk SARSr[elated]-CoV that encode functional proteolytic cleavage sites, and if so, introduce these changes into the appropriate high abundant low risk parental strain.<sup>1314</sup>

In basic terms, DEFUSE researchers were looking for SARS-related viruses with a site in the S2 subunit of its spike protein that, when split by the furin enzyme, enabled efficient cleavage of the spike protein into discrete S1 and S2 subunits. The scientists were hoping to find a SARS-related virus with naturally occurring proteolytic cleavage sites.

If such viruses could not be found in nature, DEFUSE researchers proposed artificially inserting “human-specific” furin cleavage sites into SARS-related coronaviruses to evaluate its effects on viral growth in human cells and pathogenicity in humanized mice.<sup>1315</sup> This gain of function experiment could create SARS-related viruses with a furin cleavage site that had not yet been found or perhaps did not exist in nature. A furin cleavage site in a SARS-related coronavirus would increase pathogenesis and transmissibility. Furin cleavage sites have an established role in viral pathogenesis in H5 and H7 highly pathogenic avian influenza subtypes. They also play a role in the pathogenesis of Ebola, Marburg and HIV viruses.<sup>1316</sup> In 2006, U.S. researchers inserted a furin cleavage site into SARS’s spike protein which resulted in “efficient cleavage” of the spike protein to generate discrete S1 S2 subunits and “markedly increase the ability of the spike complex to mediate cell fusion.”<sup>1317</sup> While the DEFUSE proposal envisioned this work being done in the U.S., scientists at the WIV and other Wuhan based research institutes had demonstrated the ability and possessed the equipment necessary to insert a furin cleavage site in a related alpha coronavirus strain as early as 2015.<sup>1318</sup>

DEFUSE researchers were also interested in another section of the spike protein of SARS-related viruses, the receptor binding domain (RBD) found in the S1 subunit. EcoHealth and WIV researchers identified that “small deletions [of amino acids] at specific sites in the RBD alter risk of human infection.” “We will analyze the functional consequences of these RBD deletions on SARSr[elated]-CoV [human] ACE2 receptor usage, growth in HAE cultures and *in vivo* pathogenesis.” They further proposed repairing amino acid deletions in the RBD to evaluate “whether RBD deletion repair restores the ability of low-risk strains to use human ACE2 and to grow in human cells.” DEFUSE scientists also intended to model likely changes in the RBD of SARS-related viruses and then introduce the anticipated changes into “low risk” viruses to see if they increased the virus’s ability to infect human lung cells (HAE) and increased pathogenesis in *in vivo* animal studies (presumably humanized mice).

After virus sampling was completed, the project planned to build a predictive model of coronavirus diversity using, not only samples collected during Project DEFUSE, but over “10,000 previously collected bat samples from 6 Asian countries under our USAID-funded PREDICT project” which reportedly yielded over 1,800 viral strains (both coronaviruses and others). Once the predictive model was validated, Project DEFUSE proposed creating an application that would warn soldiers if they were in an area likely to have bats carrying high risk coronaviruses with the potential to infect humans. Phase II of the project involved creating medical countermeasures that would boost bats immune system response and, it was hoped, result in the bats’ immune system fighting SARS-related viral infections which would in turn reduce spillover risk.

According to the DEFUSE proposal, researchers anticipated recovering between three to five viable SARS-related viruses per year. DARPA did not approve or fund this proposal. Whether any of this research was approved or funded by other potential U.S. or China sponsors or performed by the WIV is unknown. Experts interviewed as part of this investigation believe that WIV researchers had the



technical competence to complete the proposed research, otherwise they would not have participated in the grant application. Some experts believe that it is likely that WIV researchers would have completed part, if not most, of the underlying research prior to submitting the DARPA proposal.

**e. Other WIV Research: SARS-related Viral Research in Transgenic Mice and Palm Civets**

Another clue about research at the WIV arises from a July 2020 *Science* interview with Shi Zhengli. She stated that the WIV performed *in vivo* SARS-related experiments in transgenic (human ACE expressing) mice and palm civets in 2018 and 2019.

We performed *in vivo* experiments on transgenic mice (human ACEs expressing) mice and civets in 2018 and 2019 in the Institute's [WIV] biosafety laboratory. The viruses we used were bat SARSr[elated]-CoV close to SARS-CoV. Operation of this work was undertaken strictly following the regulations on biosafety management of pathogenic microbes in laboratories in China. The results suggested that the bat SARSr-CoV can directly infect civets and can also infect mice with human ACE2 receptors. Yet, it showed low pathogenicity in mice and no pathogenicity in civets. These data are being sorted and will be published soon.<sup>1319</sup>

She did not specify which SARS-related strains were studied. No any data or published studies have been released at the time of this report.

The significance of these findings Shi shared is relevant to the origins of SARS-CoV-2. The fact that the WIV was studying SARS-related strains that had low and no pathogenicity in humanized mice and palm civets respectively reflects similarities to SARS-CoV-2. Low humanized mouse pathology was noted in two studies published early in the pandemic.<sup>1320,1321</sup> In both studies humanized mice, aged (6-11 mos.) and juvenile (4.5 week) were intra-nasally infected. In both studies, aged mice lost 8-10% of their body weight 5 days post-infection but suffered no mortality. In contrast, 2007 human (h)ACE transgenic mice studies in SARS experiments had 100% mortality.<sup>1322</sup>

Other than Shi's *Science* interview, there is no other published evidence or public reference to WIV SARS-like virus research with transgenic mice or palm civets in the months leading up to the pandemic. Shi and her team first used transgenic mice at the WIV to study SARS-CoV-2 and the known outbreak.<sup>1323</sup> No studies infecting palm civets at the WIV have ever released.

## Chapter 11: Evidence of Research-Related Event Hypothesis & Outstanding Questions

### Introduction:

The range of research activities evaluated as part of the investigation into the possibility of a research-related origin to the COVID-19 pandemic span field collection of bat coronavirus samples, initial laboratory viral isolation and characterization, cell (*in vitro*) and animal (*in vivo*) testing and medical countermeasure development, including vaccine research. Each phase of this research presents distinct risks for incidents, accidents, hazardous aerosol exposures and possible laboratory-acquired-infections. Particularly, if some of these activities were done at BSL-2 or in a poorly functioning BSL-3 facility. Inadequate training and budgets would further increase the risk of a research-related incident.

The first section of this chapter examines the possibility that the WIV may have had SARS-CoV-2 or a close progenitor virus in its possession prior to October to November 2019. This section includes an analysis of the trajectory of the WIV's SARS-related virus research that suggests, starting no later than early 2018, the WIV was interested in discovering or engineering a SARS-related virus with characteristics like SARS-CoV-2. This section will also examine why the WIV may not have published or otherwise publicly revealed that it had SARS-CoV-2 or a close progenitor in its possession prior to the start of the COVID-19 pandemic.

Section two identifies potential risks posed by coronavirus research by analyzing specific published WIV research, internal reports, procurements, intellectual property and available epidemiological data and modeling. Internal WIV administrative and Chinese Communist Party (CCP) branch reports uncovered during this investigation and WIV patents and procurements suggest officials were aware of a variety biosafety and biosecurity deficiencies that needed to be remedied. An internal WIV report from mid-November 2019, specifically references past research-related incidents that may have resulted in unrecognized infectious aerosol releases. These reports and incidents occurred at a time when WIV researchers were likely conducting SARS-CoV-2 vaccine development, including animal infection and challenge studies.<sup>1324,1325</sup>

Section three of this chapter presents scenarios based on the available evidence to illustrate how research-related incidents might have resulted in human infection(s) with the virus. This section is like the zoonotic analysis portion of this report and details scenarios that illustrate ways in which SARS-CoV-2 could have first infected humans as a consequences of a research-related event. However, in contrast to the previous zoonotic hypotheticals, which are based largely on precedent and prototypical events but lack specific supporting facts from the COVID-19 pandemic, this chapter integrates data related to research-related activities at the WIV that can be further applied to plausible, rather than merely hypothetical, scenarios.

The fourth section identifies outstanding questions relating to the plausibility of a research-related incident. It identifies critical gaps in information and understanding of the origins of SARS-CoV-2 and the pandemic. Addressing these gaps could provide greater clarity and certainty into possible origins of the virus and the circumstances around the outbreak.

## 1. Evidence SARS-CoV-2, or a Direct Ancestor, Was in Wuhan Before the December 31, 2019

Proponents of a zoonotic origin for SARS-CoV-2 have emphasized that “there is no data to suggest that the WIV – or any other laboratory – was working on SARS-CoV-2, or any virus close enough to be the progenitor, prior to the COVID-19 pandemic.”<sup>1326</sup> Absent scrutiny, this statement is true: To date, the WIV has denied that it had SARS-CoV-2 or a close progenitor its possession prior to the COVID-19 pandemic. However, this position makes a number of unwarranted assumptions while ignoring relevant circumstantial evidence indicating that the WIV was looking for and could have had SARS-CoV-2 or a close progenitor in its possession prior to the COVID-19 pandemic.

### a. Research Conducted at the WIV Leading Up to the Pandemic

In the years leading up to the pandemic, the WIV collected more than 20,000 bat-related samples.<sup>1327</sup> During this period, WIV researchers actively sampled bats in Southern China and mainland Southeast Asia where the SARS-related viruses most similar to SARS-CoV-2 have been collected and identified.<sup>1328</sup> Viruses collected from these regions are 91.5 to 96.8 % similar overall to SARS-CoV-2.<sup>1329</sup> These include RaTG-13, which was collected by WIV researchers in Yunnan Province and the BANAL series of viruses collected by Pasteur Institute researchers in Laos.<sup>1330,1331</sup>

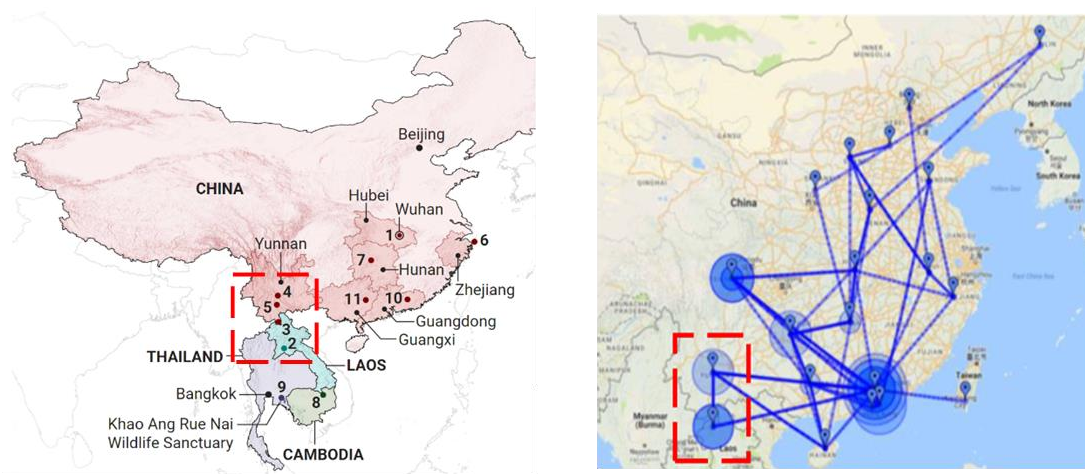

Figure 61. Graphic on the left depicts the geographic distribution of SARS-related viruses to SARS-CoV-2 in China & Southeast Asia. The graphic on the right depicts phylogenetic analysis performed on EcoHealth Alliance in 2018.

The red boxed area identifies the geographic area where RaTG-13 (Yunnan Province) and the BANAL series (Northern Laos) SARS-related coronaviruses were discovered.

Following sample collection, WIV researchers and other Wuhan institutions isolated, sequenced and then characterized newly discovered coronaviruses.<sup>1332</sup> Sometimes, viral fragments would be recovered from field samples that did not replicate in laboratory settings. Consequently, WIV researchers used published techniques to “rescue” viruses.<sup>1333</sup> Rescuing non-viable viral fragments involved experiments combining genetic material from multiple viruses, to create “chimeric viruses” with the express goal of determining how a virus may evolve in nature to infect humans and become a potential pandemic pathogen.<sup>1334</sup>

Some of these chimeric viruses acquired the ability to infect human cells and evade existing medical countermeasures.<sup>1335</sup> Publications show WIV researchers conducted infectious chimeric virus *in vitro* experiments in BSL-2 settings.<sup>1336</sup> NIH guidelines specify that such research should be conducted in BSL-3 laboratories.<sup>1337</sup> Some U.S. laboratories performing similar experiments with SARS-related viruses used enhanced levels of respiratory protection above that required by NIH (*i.e.*, powered air purifying respirators rather than N-95 respirators).<sup>1338</sup>

Such chimeric viruses could have the potential for higher human infectivity compared to the natural viruses used to create them.<sup>1339</sup> The level of infectivity would not be immediately known to the researcher and only learned through subsequent experimentation.<sup>1340</sup> This is exemplified by experiments conducted by WIV researchers in support of EcoHealth Alliance in the years leading up to the pandemic. In 2016, EcoHealth Alliance submitted summaries to NIH that showed three bat SARS-related viruses created by WIV researchers unexpectedly “at times reproduced far more quickly [in humanized mice] than the original virus on which they were based.”<sup>1341</sup> The summaries also stated “[t]he altered viruses were also somewhat more pathogenic, with one causing the mice to lose significant weight.”<sup>1342</sup> Whether or not the specific research identified in these EcoHealth Alliance updates is unduly risky has been the subject of debate among scientists.<sup>1343</sup>

While the complete scope of coronavirus research conducted at the WIV is unknown, documents like the annual NIH progress reports provided by EcoHealth Alliance provide insights to better understand the status of coronavirus research at the WIV prior to the pandemic. Those documents show the WIV’s genetic manipulation experiments were an integral part of the Institute’s coronavirus research effort. As a further example, EcoHealth Alliance, in its DEFUSE grant proposal, sought to conduct genetic altering experiments on SARS-related viruses with the intent of finding specific traits that made viruses a “high-risk” for zoonotic spillover into animals and humans.<sup>1344</sup> Notably, the proposal describes the WIV’s intent to search for SARS-related viruses that bind to human ACE2 receptors, but whose spike protein differs from SARS by 10-25% and have naturally occurring or partial furin cleavage sites. SARS-CoV-2 spike protein is approximately 24% different from that of SARS and it is the only SARS-related virus discovered to date to have a furin cleavage site.<sup>1345</sup> WIV and EcoHealth Alliance scientists were looking for a SARS-related virus with the following traits:

*Table 8. Traits of Prospective Pandemic Potential Pathogens & SARS-CoV-2*

<b>Desired Traits</b>	<b>SARS-CoV-2</b>
Diverges from SARS-CoV’s spike by between 10-25%	✓
Have recombinant chimeric spike proteins showing genetic exchange between human ACE2 and non-human ACE2 (clade I and II) SARS-related strains	✓
Have bat ACE2 receptors that might select for spike [protein] Receptor-Binding-Domains (RBD) that can use human ACE2 receptors for entry	✓
Have a complete proteolytic (furin) cleavage site	✓

If scientists were unable to find a SARS-related virus with these traits in nature, EcoHealth Alliance proposed to manipulate the receptor binding domain of SARS-related viruses to increase their

binding affinity to human lung tissue.<sup>1346</sup> EcoHealth Alliance's DEFUSE proposal describes insertion of human furin cleavage sites at the same location where one appears in SARS-CoV-2.<sup>1347</sup>

The EcoHealth Alliance DEFUSE proposal did not receive U.S. Government funding. However, reporting suggests that the WIV may have completed some or all of the proposed genetic manipulation experiments nonetheless.<sup>1348</sup> Regardless, this proposal shows that WIV researchers had the interest and the technical ability to conduct such experiments.<sup>1349</sup> To date, SARS-CoV-2 is the only known coronavirus to have all the traits sought by the DEFUSE proposal.

#### **b. Delays Between Discovery and Publication in Coronavirus Research**

The assumption that the WIV would immediately publish virus sequences from collected samples is not correct. This is not how the orderly process of viral discovery and academic publication generally works, including at the WIV. Researchers sometimes wait years to publish experimental data until it is scientifically relevant. For example, the WIV collected what is now known as RaTG-13 in June, 2013.<sup>1350</sup> WIV researchers then published a partial sequence of RaTG-13 in 2016.<sup>1351</sup> The spike protein and remaining segments of RaTG-13 were sequenced in 2018 but not published.<sup>1352</sup> The full RaTG-13 sequence was only published in a February 2020 after WIV researchers realized how similar it was to SARS-CoV-2.<sup>1353,1354</sup>

The discovery of SARS-related virus SHC014 is another example. SHC014 was collected by WIV scientists during a sampling expedition to Yunnan Province in 2011-2012.<sup>1355</sup> The article announcing its discovery was published in October, 2013 but made no further disclosure of the virus until 2018 when it was included in an EcoHealth Alliance NIH annual grant report.<sup>1356,1357</sup> Even then, annual grant reports are not ordinarily available for public review. During that period, WIV researchers grafted the SHC014 spike protein onto a SARS backbone virus and infected humanized mice to test its pandemic potential.<sup>1358</sup> Although the preliminary results showed unexpected significant viral growth and more severe disease in the humanized mice, the researchers only disclosed the data to NIH.<sup>1359</sup> The implications of these findings were significant to the broader scientific community as this experiment showed that recombination could result in increased potential coronavirus transmissibility and virulence.<sup>1360</sup> The documents related to these experiments became known to the public as a result of Congressional oversight and investigative journalism.

A more recent example of delays in publishing on SARS-related strains may be due to new implementation of new scientific techniques or protocols. WIV researchers published a new protocol for isolating additional SARS-related viruses from previously collected samples. Using exogenous trypsin, they successfully isolated two new clade 1 (possessing ACE2 receptors) and one new clade 2 (lacking ACE2 receptors) from 100 *Rhinoliophus sinicus* fecal samples collected between 2012-2019. Supplying higher trypsin levels permitted both ACE2-dependent and -independent sarbecoviruses to be grown in cultures that previously could not.<sup>1361,1362</sup>

Even with the exigent circumstances of the COVID-19 pandemic and resulting increase in funding and support, the process of collecting, screening, isolating, characterizing, and experimenting on coronaviruses can impose a lengthy delay between discovery and publication. The BANAL series of

viruses, which contain the closest known relatives of SARS-CoV-2 were collected in 2020.<sup>1363</sup> The article announcing their discovery was submitted on September 3, 2021, and formally published on February 16, 2022.<sup>1364</sup> Similarly, the SARS-related virus RmYN02, which is 93.3% similar to SARS-CoV-2, was collected between May and July 2019. The article announcing its discovery was first published a year later, on May 11, 2020.<sup>1365</sup> Many scientific journals, particularly the most prestigious ones, encourage withholding public disclosure of underlying data or scientific discoveries until publication giving the journal exclusivity.

These examples highlight the fact that there are several reasons why a researcher might not immediately, as in the case of RaTG-13, or ever publish data related to a newly identified SARS-related bat virus. Even if a scientific discovery is worthy of publication, the time needed to perform the science, analyze the data and draft a manuscript can be lengthy and delay publication.<sup>1366</sup>

PRC censorship raises another reason to scrutinize the timeliness and transparency of SARS-CoV-2-related research in China. PRC censorship orders issued in March 2020 centralized review of all COVID-19 publications under a special task force.<sup>1367</sup> The plan is described in a notice that was marked, “not to be made public,” and applied to all universities, companies and medical and research institutions in China.<sup>1368</sup> Recently release emails suggest that the existence of the RaTG-13 strain was not approved for release.<sup>1369</sup>

### **c. Unpublished SARS-Related Viruses in the WIV Database and Censorship**

On September 12, 2019, the WIV removed the Wildlife-Borne Viral Pathogen Database from its website, including a password protected section for data not yet published. The database reportedly contained more than 15,000 samples from bats and over 1,400 bat viruses.<sup>1370</sup> 220 of the viruses were SARS-related viruses.<sup>1371, 1372</sup> The disabled database reportedly held an estimated 100 unpublished sequences of SARS-related viruses, the sub-genera to which SARS-CoV-2 belongs.<sup>1373</sup>

Despite the WIV denying having SARS-CoV-2 or a progenitor virus in their possession prior to the COVID-19 outbreak, the Institute has never disclosed the unpublished viral sequences or to allow an independent review of the unpublished sequences.<sup>1374</sup> Western researchers who have collaborated with the WIV on coronavirus research do not seem to know the full extent of the WIV’s holdings. EcoHealth Alliance President and Chief Scientist Peter Daszak has stated, “I’ve never actually seen the database. I’ve seen pages of it from the internet, Twitter, chats. But I’ve never looked at the database.”<sup>1375</sup> Daszak reasoned this is because “[w]e didn’t need to! We had all the data we needed.”<sup>1376</sup>

While on the one hand, EcoHealth Alliance was satisfied with the amount of information WIV researchers were sharing as it related to projects funded with NIH sub-grant funds, Daszak went on to intimate that EcoHealth Alliance was not completely aware of the research WIV scientists were conducting before the pandemic, particularly research using other funds. This is highlighted by Daszak’s lack of insight into the history of RaTG-13, to which he iterated, “RaTG-13 was not from a sample collected under the [EcoHealth Alliance] NIH grant. So, we didn’t have any oversight on that or any knowledge of it.”<sup>1377</sup> Consequently, after years of ongoing collaboration, the insights of non-WIV

scientists are seemingly of limited value regarding the question of what exactly WIV researchers were studying and what strains they could have manipulated leading up to the pandemic.

Nonetheless, WIV publications, U.S. grant documents and presentations provide some sense of the types of viruses that were known to be in the WIV's possession. By 2018, the WIV had 47 bat sampling sites across China with Yunnan, Guangxi and Guangdong provinces where bats carry coronaviruses that have an affinity for human ACE2 receptors.<sup>1378</sup> Grant documents submitted to NIH stated that the WIV's sampling efforts in conjunction with EcoHealth Alliance resulted in 671 individual bat samples from 20 species in 2017 alone.<sup>1379</sup> EcoHealth's Year 4 grant summary included analyses of genetic sequences obtained from northern Laos. The strains or sequences recovered from this region were not identified in this summary.

Beyond what is known from limited disclosures related to projects from U.S. government funding sources, the WIV was also involved in sample expeditions undertaken as part of the China National Global Virome Initiative.<sup>1380</sup> Funding from this program supported the 2019-2020 sampling expedition that discovered RmYN02 in southern Yunnan Province which is near where the BANAL coronavirus strains were recovered. These locations were between 3 and 23 miles from the border with Laos and significantly overlaps the 10–18-mile estimated range for bat migration.<sup>1381,1382</sup> Further insights might be deduced if the PRC allows independent third parties to review information related this program and other experiments that were domestically funded.

## **2. Likelihood or Evidence of a Research-related Incident at WIV**

### **a. Background**

Leading up to the pandemic, the WIV had significant biosafety and biosecurity shortcomings that were detailed in U.S. State Department cables, administrative reports, academic publications, biosafety patents, and procurements.<sup>1383,1384,1385,1386</sup> With the start of operations at the WIV's new BSL-4 laboratory in late 2017 to 2018, government officials pressured WIV researchers to perform cutting edge infectious disease research to achieve “leapfrog development” in order to contribute to China's national goals for biotechnology.<sup>1387</sup> During this period, biosafety concerns continued to be raised even as pathogen research at the WIV increased in sophistication and scale.<sup>1388</sup>

Efforts by the WIV to improve biosafety were hampered by a lack of access to advanced foreign biosafety technologies and materials. This lack of access was called the “stranglehold” problem by WIV researchers and safety experts.<sup>1389</sup> As the Secretary General of the CCP Committee at the WIV emphasized during a June 2019 meeting with WIV officials, addressing the “stranglehold problem” was critical to “pushing forward the construction and... development of science and technology for the nation.”<sup>1390</sup> The WIV's limited access to key foreign biosafety technologies forced the *ad hoc* development and production of domestic biosafety methods and equipment. The limits of the WIV's organic biosafety capabilities may have been exceeded by a virus that had high potential for human respiratory infectivity.

### **b. Biosafety Operational Problems**

The WIV's budget and number of trained and experienced biosafety professionals did not keep pace with the scope, scale, and sophistication of its virology research.<sup>1391</sup> For example, in November 2019 WIV BSL-4 researchers complained that they had to overcome “the three no's”: “no equipment and technology standards, no design and construction teams, and no experience operating or maintaining” a high-containment laboratory.<sup>1392</sup> While they also reported success in addressing these challenges, biosafety patents filed by WIV researchers indicated an ad hoc, trial and error approach.

The WIV's BSL-3 laboratories may have had greater resource, equipment and personnel deficiencies affecting biosafety than the BSL-4 laboratory.<sup>1393</sup> On March 1, 2019, a procurement notice was published soliciting competitive bids for the maintenance project of the BLS-3 laboratory and experimental animal center at the WSIV's new campus (Zhengdian Park) that had yet to become operational.<sup>1394</sup>

In May 2019, the Director of the WIV BSL-4 laboratory warned that in high-containment laboratories in China:

Maintenance cost[s] [are] generally neglected; several high-level BSLs have insufficient operational funds for routine yet vital processes. Due to the limited resources, some BSL-3 laboratories run on extremely minimal operational costs or in some cases none at all...

Currently, most laboratories lack specialized biosafety managers and engineers. In such facilities, some of the skilled staff are composed of part-time researchers. This makes it difficult to identify and mitigate potential safety hazards in facility and equipment operation early enough. Nonetheless, biosafety awareness, professional knowledge, and operational skill training still need to be improved among laboratory personnel.<sup>1395</sup>

This investigation found evidence that throughout 2019, the WIV attempted to address biosafety deficiencies through domestically designed equipment and corrective procurements. A series of procurements and patents in the Fall of 2019 highlight several biosafety-related issues proximate to the time of COVID-19's emergence in Wuhan. Of particular note are multiple patents and procurements related to the maintenance of negative pressure inside laboratories and high-containment biosafety equipment such as autoclaves; ensuring air sanitization; and reducing corrosive impact of disinfectants.

BSL-3 laboratories depend on negative pressure to maintain protective biocontainment. On April 24, 2019, WIV researchers submitted a patent for an auxiliary exhaust fan to maintain negative pressure gradients in BSL-3 and BSL-4 high-containment laboratories. Maintaining negative pressure gradients ensures biocontainment is particularly important in BSL-3 laboratories as they are not hermetically sealed like BSL-4. This auxiliary fan was intended to prevent the risks of loss of negative pressure in the event of fan control failures, mechanical failures during fumigation and human error. It was also intended to assist in fumigation with disinfectants during post-experiment sanitization. These exhaust fans also addressed problems disinfecting ventilation shafts and improving penetration of disinfectants into HEPA filters.<sup>1396</sup>



On August 14, 2019, the WIV issued a procurement notice for a project involving its environmental air disinfection system and scalable automated sample storage management system. The procurement order was issued by the original Xiaohongshan WIV campus specifying that it was for BSL-3 and ABSL-3 laboratories there. The budget for the project was approximately U.S. \$1.3 million.<sup>1397</sup> This upgraded disinfection system used vaporized hydrogen peroxide to decontaminate laboratory surfaces. A gaseous hydrogen peroxide disinfection system is an effective, less corrosive means to sterilize a laboratory than formaldehyde and other such agents used by WIV researchers.<sup>1398</sup>

A November 15, 2019 WIV patent describes an invention that is a tourniquet used in WIV biocontainment laboratories when researchers are “exposed accidentally, especially when wounds such as needle pricks and blade cuts occur.”<sup>1399</sup> The invention is a tube-like device that goes over the injured finger. This novel device would appear to mitigate the risk of excessive bleeding from an animal bite, accidental needle-stick or other puncture wound. Puncture wounds are the most common source of identified laboratory accidents and one of the most common routes of confirmed laboratory-acquired infections.<sup>1400</sup> A tourniquet of this design would not, however, eliminate all risk of subsequent infection if the researcher was exposed to a highly infectious agent.<sup>1401</sup>

On November 19, 2019, the WIV issued a sole source, short suspense procurement request for an air incinerator at the original WIV Xiaohongshan campus.<sup>1402</sup> Air incineration is a historic but effective means to sterilize “air exhausted from ... aerosol chamber[s] or from ... apparatus employed for respiratory challenge of animals.”<sup>1403</sup> Prior to the advent of HEPA filters, air incinerators, though expensive to install and operate, were the mainstay of high-containment air sterilization.<sup>1404,1405,1406</sup>

The procurement stated that the incinerator was needed to sterilize exhaust gas from a biosafety autoclave at the WIV Xiaohongshan campus. The procurement described the current autoclave system as having a serial, double HEPA filter assembly. The air incinerator would be added to the autoclave exhaust pipe to incinerate all the exhaust gas discharged from the autoclave.<sup>1407</sup> This procurement suggests that the WIV’s autoclave at its central Wuhan campus was not completely sterilizing infectious contents and/or the autoclave HEPA filters were not sufficiently sanitizing potentially infectious exhaust gases.

A related patent submitted earlier on April 22, 2019, indicated WIV researchers encountered problems with biosafety autoclaves being used to sterilize waste generated by infectious pathogen experiments.<sup>1408</sup> They cited problems (1) not being able to achieve required sterilization temperatures; (2) potential leaks around the autoclave doors; and (3) excessive condensation and moisture of autoclaved infectious materials.<sup>1409</sup> The patent proposed changing the procedure leaving the autoclave exhaust valve open during the sterilization process. This practice appears to be at variance with typical autoclave procedures and warranted further examination.

*"The exhaust gas discharge valve is opened. In the present invention, the **fourth** pneumatic diaphragm valve (tail [exhaust] gas pipeline valve) **is kept open during the sterilization process, and the tail (exhaust) gas is discharged after 3 stages of filtration."***  
(Serial HEPA & Carbon filters)

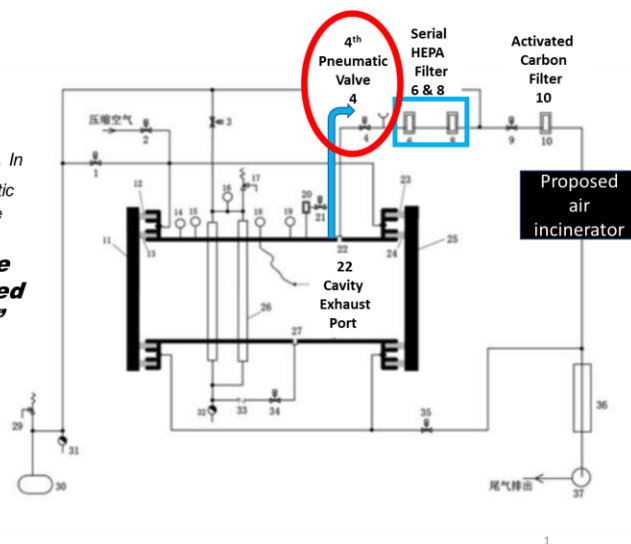

Figure 62. Graphic depiction of Biosafety Autoclave contained in the April 22, 2019 WIV patent describing changes to the design and procedures. The insertion of the proposed November 19, 2019 procurement of an air incinerator is superimposed on the graphic as it was described in the procurement notice. Source: *Wuhan Institute of Virology*. 2019. Patent: No. 201910325059.0 *Biosafety autoclave and sterilization method*. <https://patents.google.com/patent/CN210078382U/en?assignee=Wuhan+Institute+of+Virology+of+CAS&sort=new&page=12> "The Wuhan Institute of Virology of the Chinese Academy of Sciences plans to use a single-source procurement method to publicize the procurement of air incineration devices and test service projects." *China Government Procurement Network*, 3 Dec. 2019, <https://archive.is/Jifqr#selection-229.0-229.197>

An autoclave uses direct steam contact to sterilize materials. There are four parameters of autoclave sterilization: steam, pressure, temperature, and time. Dry saturated steam (dryness fraction  $\geq 97\%$ ) is used preferentially in sterilization.<sup>1410</sup> Pressure (15 pounds per square inch) ensures achieving the high temperatures necessary to quickly kill microorganisms. Specific temperatures must be obtained to ensure microbicidal activity. There are two common steam-sterilizing temperatures: 121°C (250°F) and 132°C (270°F).<sup>1411</sup> These temperatures must be maintained for a minimal time to kill microorganisms. The time required is dependent on the type of autoclave and temperature used. Time is also determined by the type of product to be sterilized and the nature of the infectious material to be disinfected.<sup>1412</sup>

There are two basic types of steam autoclaves: a gravity displacement autoclave and a high-speed pre-vacuum sterilizer. In the former, steam is injected at the top or the sides of the sterilizing chamber. Because steam is lighter than air, it forces the air out the bottom of the chamber through a vent drain. Gravity displacement autoclaves are primarily used to process laboratory media, water, pharmaceutical products, regulated medical waste, and nonporous articles whose surfaces require direct steam contact.<sup>1413</sup> The high-speed pre-vacuum sterilizers are similar to the gravity displacement autoclaves except they are fitted with a vacuum pump to ensure air removal from the autoclave before the steam is injected.<sup>1414</sup>

According to established practices for either type, air within the autoclave chamber is typically removed during or prior to the injection of pressurized steam during the first stage of the sterilization cycle described as the 'purge' phase. Air is removed and filtered through a HEPA filter to prevent the escape of potential infectious aerosols. Once a vacuum is created, the second stage of the sterilization

cycle begins with the injection of pressurized steam to meet the requisite temperature, pressure and duration based on pre-existing biosafety recommendations and best practices.

The April 2019 WIV patent described leaving the “exhaust valve open and then inject[ing] steam into the chamber ... to achieve heating and sterilization, which has the advantage of precise control of temperature and ensures very good drying effect by vacuum after sterilization.” The process described could negatively impact achieving the temperature and pressure parameters required for effective sterilization. Further, according to biosafety experts, exhausting pressurized steam through serial hydrophilic HEPA filters could degrade them and reduce their overall effectiveness over time. Experts indicated that the risk could be mitigated with routine HEPA filter inspections, maintenance and filter replacement as required. Inspection of HEPA filters is recommended annually and replaced as needed.<sup>1415</sup> Whether the November 19, 2019 air incinerator procurement was necessary to address the particular risk of HEPA filter failure is not known.

A December 11, 2019 WIV patent indicates that WIV’s transfer cabinet design suffered an unrecognized HEPA filter failure.<sup>1416</sup> A biocontainment transfer cabinet is used to move infected laboratory animals from a BSL-3/BSL-4 laboratory to a holding ABSL-3/4 facility or transfer them from animal holding rooms to a specific procedure room.<sup>1417</sup> According to researchers from the Wuhan University Institute of Animal Models ABSL-3 laboratory, infected animals create a variety of potential hazardous infectious aerosols from urine, feces, fur and by respiration.<sup>1418</sup> Transporting an infected experimental animal requires ensuring sufficient air exchange to meet the physiological needs of the animal while preventing the inadvertent release, including escape, of the animal or the agent.<sup>1419</sup> These units are designed to pump in HEPA filtered air for the animals and expel twice HEPA filtered air out of the cabinet. Ensuring the exhaust air is effectively HEPA filtered is a critical biocontainment feature.

The problem the patent addressed was “when an accident occurs in the transportation process, an effective monitoring device is not available for judging whether the equipment is normal [operating] or not.”<sup>1420</sup> The patent described developing a sensor to detect when HEPA filters had failed or were not operating correctly.<sup>1421</sup> This particular patent application described specific problems with a HEPA filter connection that resulted in “multi-stage” risks.<sup>1422</sup> The patent described the requirement that the HEPA filter holder should be “preferably made of 7075 aircraft aluminum alloy which is corrosion resistant...”<sup>1423</sup> Stainless steel corrosion is a well-documented challenge in both the food and pharmaceutical industries and biosafety laboratories.<sup>1424</sup> China made extensive use of stainless steel in the design and construction of its high-containment laboratories and equipment for cell-level and small- and medium-sized animal infections studies.<sup>1425</sup>

This investigation also identified the type of liquid disinfectant the WIV reportedly used in its high-containment laboratories. As described in a published study, the WIV used a more concentrated disinfectant than recommended by its manufacturer.<sup>1426, 1427</sup> As described by the U.S. licensed manufacturer of the product, “the higher ... concentration, the more corrosive the solution will be.”<sup>1428</sup> A November 13, 2020, WIV patent details an improved formulation for a liquid disinfectant used in their high-containment laboratories.

The improved formulation “[r]educ[e]s the corrosion effect to metal, especially stainless-steel material.” The patent echoing the manufacturer’s warning concludes that: “[l]ong-term use [of the previous disinfectant] will lead to corrosion of metal components such as stainless steel, thereby reducing the protection of ... facilities and equipment...shorten[s] its service life and cause economic losses, but also lead to the escape of highly pathogenic microorganisms into the external environment of the laboratory, resulting in loss of life and property and serious social problems.<sup>1429</sup>

### **c. SARS-CoV-2 Novel Characteristics & BioSafety Precautions**

SARS-CoV-2 is unlike any previously identified SARS-related coronavirus. The virus’ characteristics: innate human affinity, transmissibility, asymptomatic spread, and lower virulence are unique.<sup>1430,1431,1432,1433</sup> The WIV’s initial BSL-2 handling and experimentation of unknown natural and recombinant SARS-related viruses did not conform with established international biosafety norms. While the WIV’s past experience with less infective SARS-related viruses established an institutional precedent, this approach did not consider the potential unexpected discovery or unanticipated outcome of reverse genetic experiments resulting in enhanced infectivity or virulence.

Researching novel coronaviruses emanating from either nature or laboratory experimentation required at least BSL-3 level conditions. Concerns about the creation of “new kinds of hybrid plasmids or viruses, with biological activity of unpredictable nature, may eventually be created” and “may prove hazardous to laboratory workers and to the public” were first raised in 1973. The first NIH guidelines were issued in 1975 and subsequently revised several times.<sup>1434</sup> The published precedence for using enhanced BSL-3 procedures when conducting SARS-related recombinant research was established in 2015.<sup>1435</sup> The WIV’s existing BSL-3 biosafety guidelines, procedures, and safeguards involving chimeric SARS-related viruses may have been inadequate for this kind of research or handling a virus such as SARS-CoV-2. It may have, however, been the result of limitations invoked by the PRC Government.

As noted in a 2018 U.S. State Department cable, the WIV’s new BSL-4 was not initially accredited to work with the human SARS virus.<sup>1436</sup> The WIV BSL-4 laboratory obtained permission from the National Health and Family Planning Commission (NHFPC) to perform research on Ebola, Nipah and Xinjiang hemorrhagic fever viruses. Despite this permission, the PRC Government did not permit the WIV to import Ebola viruses. Further, despite Shi Zhengli’s BSL-4 training and research on coronaviruses such as SARS and MERS, the NHFPC denied her request to study these viruses in the WIV’s BSL-4 laboratory. How this described “opaque government review and approval processes” impacted WIV biosafety guidelines and practices related to coronavirus research could not be ascertained.<sup>1437</sup>

The initial isolation, creation, or characterization of a novel SARS-related coronavirus may have gone unrecognized. According to WIV’s research protocol, a virus with human affinity and virulence would be first demonstrated in cell culture experiments that were conducted in BSL-2 conditions. The pathogenicity and transmissibility of the virus, however, would only be learned as the result of later humanized mice or other animal BSL-3 experiments. Standard BSL-3 precautions, however, may not have been adequate. The risk of SARS-CoV-2’s high human infectivity that required enhanced BSL-3

practices may have gone initially unrecognized. The need for positive air pressure respirators or pressure safety suits, used in BSL-4 settings, would likely be required.

Discovering a novel virus with high human infectivity like SARS-CoV-2 could plausibly result in a laboratory-acquired infection. Compounding this possibility is the likelihood individuals infected may have been asymptomatic or had mild symptoms yet could infect others. The initial infection of researchers or others could have gone unrecognized or mistaken for common disorders such as seasonal colds or allergies. The absence of specific diagnostics would further obfuscate the underlying cause or delay prompt containment or isolation of cases. Whether this chain of events indeed happened requires further data, investigation and analyses.

#### **d. Months Leading Up to the Pandemic: WIV and Government Actions**

The full scope and scale of animal experiments being conducted at the WIV in 2018 and 2019 are unclear. As of 2018 the WIV was experimentally infecting humanized mice that expressed human ACE2 receptors with chimeric SARS-related coronaviruses.<sup>1438</sup> The limited information available on the results of these experiments indicated that SARS-related bat coronaviruses could infect and cause severe illness in humanized mice.<sup>1439</sup> The full results of these experiments have never been published and the WIV was terminated as a sub-grantee by NIH for failing to produce its laboratory notes and other records relating to these experiments.<sup>1440</sup>

However, the convergence of sophisticated coronavirus research, government demands for scientific breakthroughs, and biosafety problems at the WIV appears to have peaked in the late-summer or early-fall of 2019.<sup>1441</sup> From June to August, 2019, WIV leadership published multiple reports expressing concerns about biosafety shortcomings due to limited availability of equipment and trained personnel.<sup>1442</sup> Multiple PRC government entities in Wuhan and at the national level began procuring pathogen detection (polymerase chain reaction-PCR) instruments. China conducted national, regional and local infectious disease outbreak exercises and drills.

On September 18, 2019, Wuhan officials conducted an emergency response drill at its international airport. The drill included identifying and responding to an arriving passenger infected with a novel coronavirus.<sup>1443</sup> Also in September 2019, China's National People's Congress drafted legislation to strengthen the management of laboratories involved in pathogen research and improve adherence to national standards and requirements for biosafety. It specifies that:

[L]ow-level pathogenic microorganism laboratories shall not engage in pathogenic microorganism experiments that should be conducted in high-level pathogenic microorganism laboratories...High-level pathogenic microorganism laboratories engaging in experimental activities of highly pathogenic or suspected highly pathogenic microorganisms shall be approved by the health or agriculture and rural authorities at or above the provincial level. For pathogenic microorganisms that have not been discovered or have been eliminated...relevant experimental activities shall not be carried out without approval.<sup>1444</sup>

A November 12, 2019 report by the WIV BSL-4 laboratory's Communist Party Branch expressly referenced past responses to biosafety incidents involving "high pathogen microorganisms."<sup>1445</sup> This was followed by a local news media report on November 15, 2019 about the Wuhan University's Institute of Animal Models not being involved in SARS-related vaccine studies since 2015. This false possibly deceptive report ignored or covered up non-human primate SARS vaccine challenge studies the Institute performed in 2017.

Then, on November 19, 2019, the WIV hosted a special training session led by the senior CAS biosafety/biosecurity official who relayed "important oral and written instructions" from PRC leadership to the WIV regarding the "complex and grave situation facing [bio]security work".<sup>1446</sup> From the context, the report to CCP leadership appears to have dealt with "safety and security work" at the WIV.<sup>1447</sup> At the same training session, the Deputy Director of the Office of Safety and Security at the WIV "pointed to the severe consequences that could result from hidden safety dangers, and stressed that the rectification of hidden safety risks must be thorough, and management standards must be maintained."<sup>1448</sup> The November 19<sup>th</sup> senior leadership session was followed by a two and half day remedial biosafety training session for WIV researchers and individuals from other Wuhan research institutes such as Wuhan University.

A government notice on May 6, 2020, Li Hongliang, the Director of the University Institute of Model Animals "actively offered to resign" rather than being removed from office.<sup>1449</sup> He was also removed as the director of the Wuhan University Animal Center and director of its ABSL-3 laboratory. A later September 2020 news report indicated he was being investigated for his role in his children's science research that won a national science award. As described, "Li was suspected of providing assistance in some form to their research" since "it represented rigorous logic, data processing and also strong medical support."<sup>1450</sup>

### **3. Plausible Scenarios for Research-related Infection(s) Based on Collected Evidence**

This investigation evaluated a study performed by an academic disease modeler and researcher that is currently undergoing peer review to compare potential alternative emergence mechanisms. The model uses the base case of a natural zoonotic spillover where bats were trafficked/sold/exposed in an animal "wet" market, resulting in spillover infections to other animals and humans. This analysis also considers research-related pathways. In particular, an incident of escaped lab animals that could mimic an almost identical emergence as a wet market spillover resulting in infected animals and humans.

Based on this analysis, the epidemiology of the outbreak could have resulted from several possible virus introduction scenarios. These scenarios include a solitary research-related acquired infection, escape of an infected animal as well as a natural zoonotic spillover event. The ability to discern the origin of research-related incident is challenged by the historic probability that the exact nature of the event that resulted in a laboratory-acquired infection was never determined in 80% of the cases.<sup>1451</sup>

This researcher's model also evaluates the possibility of accidental human infection in a laboratory. Multiple lineages of SARS-CoV-2 viruses early on support a laboratory event where the existence of two lineages could point to simultaneous human-human and human-animal-human infection.

The latter path is convoluted as it requires multiple events to be aligned to trigger a pandemic. This scenario could result in an index case occurring as early as July or August 2019.

In constructing these scenarios, this investigation considered the entire spectrum of possible incidents that could result in a research-related incident and subsequent laboratory-acquired infection. The nature of the documented coronavirus research conducted by the WIV and other Wuhan based research institutions incurred risks that spanned the scope of field and laboratory activities.

#### **a. Risk of Research-related incidents in Field Collection Expeditions**

The risk of research-related incidents begins with field expeditions where WIV researchers and collaborators first collect bat samples. As an expert in biomedical science policy at King's College London has said, fieldwork to collect potential pandemic viruses poses “really, really high risks” to researchers. One particularly poignant example of the risk of such field research is presented by Tian Junhua, a researcher from the Wuhan CCDC, who was featured in a television documentary released on December 10, 2019. In the film, Tian and his colleagues were shown collecting bat samples from caves in Hubei Province. The researchers operated in a challenging setting with limited light and sometimes only with partial personal protective equipment (PPE) with exposed skin. In 2017, Tian told the state-run Wuhan Evening News that he once forgot his PPE and was “splattered” with bat urine which required Tian to self-isolate for two weeks.

Tian's experience highlights that capturing bats and collecting subsequent collection of blood, urine and fecal samples risks researcher exposure to potentially infectious materials and aerosols. Handling bats also risks bites or scratches which could create wounds and provide a direct route of transmission for pathogens. These bites and scratches are often small and can go unnoticed. The handling of bats in field settings compares starkly to laboratory settings, where animals are usually sedated to avoid stress on the animal and reduce risk of researcher exposure before they are handled and samples collected. In the wild, sedating bats caught in traps itself risks being bit or scratched.

While the China-WHO report says Dr. Shi told the visiting team that all field work is done with full protective equipment (to include N95 masks, Tyvek<sup>R</sup> bodysuits, goggles and gloves), a June 2018 lecture given by Shi contradicts this statement. During the lecture, Dr. Shi described collecting bat samples wearing “thin surgical masks and rubber gloves as they work [to collect bat samples], while others are unmasked with bare hands.” According to Shi, “[i]n most cases, we'd wear simpler protection, and it's okay,” because most bat-borne diseases cannot infect humans directly. This contradicts Shi's own research where her team identified serological evidence of direct bat-to-human spillover events in human populations near bat colonies.<sup>1452</sup> A Wuhan CCDC scientist who, like the WIV team, regularly conducts bat sampling expeditions, is quoted as saying, “[i]t is while discovering new viruses that we [researchers] are most at risk of infection.” The CCDC scientist stated further, “[i]f our skin is exposed, it can easily come in contact with bat excrement and contaminated matter, which means this is quite risky.”<sup>1453</sup> According to Shi, her researchers do not adhere to these kinds of standards in practice.

The realities of possible researcher infection during sample collection are borne out in the PPE recommendations found in Applied Biosafety, where experts write, “[a]ll necessary PPE should be

available at the field site, in sizes and fittings appropriate for each individual researcher. Finally, all personnel should be trained in the risks and planned activities for each experiment.” These recommendations make sense given field expeditions pose risks to researchers.<sup>1454</sup>

Taking Shi’s seemingly nonchalant attitude toward PPE in this regard raises concerns, especially considering Shi’s own research indicating direct bat-to-human infections do, in fact, occur. Taken as a whole, these facts indicate a WIV researcher could have been infected with SARS-CoV-2 during field expedition activities. Under this scenario, an infected researcher could serve as a continuous common source of infection leading the COVID-19 outbreak in Wuhan. This scenario is consistent with the early epidemiology showing rapid spread of the virus in multiple areas of Wuhan.

Tian’s and Shi’s actions flagrantly disregard the concerns raised by the PLA researchers in the February 2019 journal article.<sup>1455</sup> No reports of incidents or infections related to these sample collection activities were identified during this investigation.

#### **b. Infection of a Researcher During Initial Laboratory Evaluation and Characterization of Coronaviruses in BSL-2 Settings**

After sample collection in the field, virus samples were transported back to Wuhan where often graduate students and technicians would follow a procedure of detecting, isolating and sequencing SARS-related bat viruses. Attempting to identify an unknown pathogen in a sample can result in isolating a viable virus. For the purposes of the WIV SARS-related virus research, extracting a viable virus and growing it into a pure culture is the idealized end-state.<sup>1456</sup>

In the years leading up to the pandemic, WIV researchers screened thousands of unknown samples using this approach.<sup>1457</sup> Each presented an opportunity for a research-related incident and possible infection. Experiments to detect, isolate, and sequence unknown pathogens involved diluting samples, suctioning, mixing, pipetting, and centrifugation.<sup>1458</sup> Accidents resulting in laboratory-acquired infections are more frequent with pipettes or syringes and needles than centrifuges.<sup>1459</sup> Centrifuges, however, deserve additional mention.

Centrifuges can produce large amounts of hazardous infectious aerosols.<sup>1460</sup> Centrifugation is notable for the possibility of two serious hazards: mechanical failure and dispersion of aerosols. A catastrophic mechanical failure can produce not only aerosols but hazardous fragments that could result in traumatic injuries to personnel.<sup>1461</sup> A centrifuge can also produce large amounts of unrecognized hazardous infectious aerosols if not properly operated also causing a risk for multiple exposures.<sup>1462</sup>

This risk was succinctly described by researchers from China. The risk of “cuts, acupuncture, direct exposure of skin, mucosa, and eyes directly exposed to infectious microorganisms...inhalation of infectious aerosols, etc.” are always present.<sup>1463</sup> Of these, aerosol exposure risk “is the most common in experimental activities.”<sup>1464</sup> In short, the initial isolation and cultivation of unknown viral pathogens that might have the ability to infect humans is risky, but even riskier if improper personal and laboratory biosafety practices are used.

In addition to the risk associated with the effort to isolate yet undiscovered viruses from thousands of samples collected from the wild, WIV researchers published studies of experiments creating



and using live, recombinant SARS-related viruses in BSL-2 settings prior to the pandemic.<sup>1465,1466,1467,1468</sup> The possibility exists that WIV researchers discovered, created or researched a novel virus like SARS-CoV-2 in BSL-2 conditions. It is further possible that a researcher may have been infected during these experiments.

Depending on the virus' virulence, the exposure could lead to a mild or subclinical illness. The asymptomatic or atypical clinical presentation may not be noticed or meet the criteria for self-reporting. Further, individual researchers and technicians who became ill may not present themselves for evaluation in light of possible punishment, loss of wages or professional stigma.<sup>1469</sup> This investigation noted that only after the outbreak of SARS-CoV-2 started were virus cultivation as well as animal experiments using the virus were mandated to be done only in BSL-3 laboratories.<sup>1470</sup>

### **c. Research-related Incident Due to Escape of an Experimental Animal**

Another route by which laboratory research could have caused the first human infection involves the escape or sale of experimental animals. Infectious laboratory animals which are or were used in experiments can escape and infect humans.<sup>1471</sup> Animal escapes can pose a risk inside and outside laboratory settings and can result from improperly secured cage lids or doors, or other containment failures.<sup>1472</sup> Infected animals that escape the laboratory can infect those in the community.<sup>1473</sup>

More generally, species known to have been sold for human consumption in live animal markets in Hubei were also known to have been experimental animals at the WIV. Shi Zhengli said in a 2020 interview with *Science* that the WIV was performing SARS-related experiments in transgenic mice and palm civets.<sup>1474</sup> Palm civets were the intermediate host of the 2003 SARS epidemic. An average of 29 palm civets total were sold each month at the 17 wet markets in Wuhan.<sup>1475</sup> As Shi detailed in her interview, the results of their studies “suggested that bat SARS-related viruses can directly infect civets and also infect mice with human ACE2 receptors. Yet it showed low pathogenicity in mice and no pathogenicity in civets. These data are being published soon.”<sup>1476</sup> These studies and data have not yet been published.

Although no evidence was found that WIV researchers sold experimental animals rather than destroying them, there is precedent for such behavior in China. On January 3, 2020, a professor at China Agricultural University in Beijing was sentenced for corruption and for selling animals and animal products after laboratory experiments. Experimental pigs, cattle, and milk were sold over the course of four years, from 2008 to 2012.<sup>1477</sup> The October 2020 draft Biosafety and Biosecurity Legislation specifically called for strengthening oversight “of experimental animals and prevent their escape.” It expressly forbade “introduc[ing] animals used in experimentation into the marketplace.”<sup>1478</sup>

Thus, the possible escape of an infected experimental animal from the WIV is a plausible explanation for causing the first human infections. In addition to the vaccine animal experiments likely conducted by Zhou, WIV researchers are on the record as having conducted SARS-related infectious studies on the types of animals that are susceptible to infection with SARS-CoV-2. Either of these efforts could have resulted in the escape of an animal infected with SARS-CoV-2.

Whether by accidental or intentional release, human contact with an infected WIV experimental animal is a possible explanation for the introduction of SARS-CoV-2 into Wuhan. WIV researchers are on the record as having conducted SARS-related infectious studies on the types of animals that are susceptible to infection with SARS-CoV-2 in the months leading up to the pandemic. Under this scenario, an infected animal(s) could serve as a continuous common source of infection leading to the COVID-19 outbreak in Wuhan. This scenario is consistent with the early epidemiology showing rapid spread of the virus in multiple areas of Wuhan. It would also be consistent with zoonotic source but research-related.

#### **d. Research-related Incident and Researcher Exposure During Animal Experiments**

Animal experiments represent an essential element of the WIV's research into potential pandemic pathogens like SARS.<sup>1479</sup> As illustrated by the vaccine animal studies performed by Zhou, CanSinoBIO-AMMS and others, animal model experiments (including those with humanized mice and non-human primates) have played an important role in the characterization of the pathophysiology of diseases. They have also served to determine mechanisms of injury, identify drug targets, and evaluate novel therapeutic agents for toxicity/safety, pharmacokinetics, pharmacodynamics, and efficacy.<sup>1480</sup> Humanized mice, in particular, are a critical tool in evaluating the pathogenic effects of SARS-related and other potential human viral pathogens. Humanized mice and non-human primates are also essential in the evaluation of potential medical countermeasures such as therapeutic drugs, antibodies and vaccines. The WIV conducted bat SARS-related virus experiments with animals including humanized mice and civets in 2018 and 2019.<sup>1481, 1482</sup> In near proximity to the original campus of the WIV, Wuhan University Institute of Animal Models performed non-human primate SARS-related vaccine challenge studies most recently in 2017.<sup>1483</sup>

In China, animal experiments involving highly infectious agents are required to be conducted in an BSL-3/ABSL-3 facilities.<sup>1484</sup> However, email correspondence in February 2020 between then-NIH Director Francis Collins, then-NIAID Director Anthony Fauci, and Director of the Wellcome Trust, a large UK-based medical research charity, Dr. Jeremy Farrar, showed concern that the WIV may have conducted SARS-related virus research using humanized mice expressing ACE 2 receptors in BSL-2 facilities:

Collins:	Yes, I'd be very interested in the proposal of accidental lab passage in animals (which ones?).
Fauci:	?? Serial passage in ACE2-transgenic mice
Farrar:	Exactly!
Collins:	Surely that wouldn't be done in a BSL-2 lab?
Farrar:	Wild West....

As described by WIV researchers in interviews and publications, they admitted to conducting SARS-related coronavirus research in BSL-2 facilities. Isolation and characterization of novel SARS-

related coronaviruses occurred at BSL-2, in accordance with the WIV's pre-COVID-19 pandemic biosafety policies. Public disclosure that the WIV was doing that in BSL-2 settings caused some experts to change their opinion as to the likely origin of the pandemic towards a laboratory accident. It appears that Dr. Farrar thought it was extremely reckless for the WIV to conduct animal infection experiments in BSL-2 laboratories with humanized mice.

It is worth noting that ABSL-3 facilities require more complex biosafety management practices than BSL-3 facilities.<sup>1485</sup> Both WIV campuses have dedicated animal holding facilities and ABSL-3 laboratories to support such experiments. Animal welfare is a central consideration so that the models used provide researchers with “reliable experimental animal data.”<sup>1486</sup> It appears the BSL/ABSL-3 facilities at the new Zhengdian WIV campus were not fully operational in the Fall of 2019. Biocontainment for mice and non-human primates used in high-containment infectious disease research requires customized animal cages based on experimental demands and the risk of the agent being studied.<sup>1487</sup> It is not clear whether the Xiaohongshan campus had the means to manage infected non-human primates. It is evident from past published research, however, that the nearby Wuhan University Institute of Model Animals did.<sup>1488</sup>

Infected animals are a significant source of infectious aerosols.<sup>1489</sup> As Wuhan University animal researchers wrote in 2019:

In the handling of animals, changing cages, dumping bedding, etc., it is easy to produce infectious aerosols from infected animal skins, furs, and bedding. These infectious aerosols are a potential hazard to workers and the environment.<sup>1490</sup>

Housing conditions for live experimental animals also affects the welfare of researchers. This is especially true in animals infected with a pathogenic agent. Improved housing conditions might reduce animal stress and pain can reduce aggression, reducing aerosol contamination and possible human infection from animal scratches and bites.<sup>1491</sup> ABSL facilities permit researchers to monitor and collect samples from their experimental animals in the time after their BSL laboratory exposure. Following exposure to a pathogenic agent and before the animal is euthanized, researchers collect a variety of data: blood markers and viral levels and other physiological measures (e.g. weight, temperature, respiration rate etc.).

Additionally, housing and transportation modules require precise air pressure maintenance, to ensure negative pressurize gradients and effective HEPA filtration. These are essential components of hazardous infectious aerosol mitigation. Though commercially available, these specialized units are often custom made. They require a dedicated HEPA filtered exhaust fan to prevent the escape of infectious aerosols. Monitoring the functionality of this HEPA filter and fan unit is essential feature of these units.<sup>1492</sup>

Hazardous animal transportation presents two scenarios that pose a risk of infection to researchers: (1) Some of the samples collected from the infected animals may be assessed within ABSL-3, and others need to be transferred out of ABSL-3 for detection. Failure to safely transfer samples out of ABSL-3 poses a potential hazard to both personnel and the environment. (2) Infected animals sometimes

need to be transferred from the animal room to the specific procedure room or necropsy room within ABSL-3 for related *in vivo* examination or necropsy. During the animal transport, the personnel and environment may be exposed to pathogens.<sup>1493</sup>

Faulty equipment or human error while transporting animal samples or animals among laboratory settings can lead to human infection and environmental contamination. While some samples and animals can be assessed within ABSL-3 settings, other are transferred out of ABSL-3 for *in vivo* examination, necropsy, or other procedures in other settings.<sup>1494</sup> During this process, infected animals generate infectious aerosols and hazardous wastes.<sup>1495,1496</sup> Special purpose wheeled containment transportation cabinets are typically used to move these animals. The cabinets are commercially available but can be made in-house. These cabinets have special fittings, are designed to ensure negative air pressure gradients, and have two serial HEPA filters to contain potential aerosol hazards. Monitoring the functionality of the component HEPA filter and fan unit is essential.<sup>1497</sup> Each encounter with an infected animal reflects a spectrum of hazards in handling the animal, collecting data and specimens and being exposed to its hazardous waste.<sup>1498</sup>

Animal challenge studies, where they are exposed to an infectious agent in a BSL-3/4 laboratory to determine route of transmission, pathogenicity, or evaluating countermeasures such as vaccines, are particularly hazardous. The way experimental animals are exposed is one specific risk. During this time, researchers and technicians collect physiological and serological data in support of their research objectives. Each encounter with an infected animal reflects a spectrum of hazards in handling the animal, collecting data and specimens and being exposed to its hazardous waste.<sup>1499</sup>

Conducting such infectious animal experiments at the WIV in the Fall of 2019 would have been challenging. The new Zhengdian campus BSL-3/ABSL-3 was not yet operational. The existing Xiaohongshan BSL-3/ABSL-3 facility was available but its status being built in 2007 would likely require improvements that may be represented by procurements identified for that campus. The facility could only support testing mice and small animals while not being able to support non-human primate studies.

The breadth of Zhou's vaccine animal experiments with SARS-CoV-2 that likely occurred at the WIV no later than November 2019 provided ample opportunities for a research-related infection, including: animal holding, operation of restraint device, anesthesia, animal challenge, *in vivo* detection, blood collection, sampling, surgery, euthanasia, necropsy, biopsy, transport of infectious materials, transfer of infected animals, daily cleaning and disinfection for animal and procedure rooms, terminal disinfection for the facility, disposal of animal carcasses and waste, and response to emergency accidents. As noted by Chinese animal researcher experts, these types of experiments that include injecting, dissecting, and squirting [nasal inoculation of] animals, poses the highest risk of researcher infection from aerosolized pathogens.<sup>1500</sup>

#### **4. Outstanding Investigative Questions**

- a. Is the Presence of a Furin Cleavage Site in SARS-CoV-2 Evidence of Artificial Insertion or Natural Recombination?**

The origin of the furin cleavage site in SARS-CoV-2 remains an enigma to the question of possible origins. No known sarbecovirus other than SARS-CoV-2 has the four (polybasic) amino acid furin cleavage site. Its presence has been described by some as potential smoking gun evidence of genetic manipulation. Several related SARS-related viruses, RmYN02, RacCS203 and BANAL-20-116 and 246 have three of the four amino acids making up the polybasic furin cleavage site found in SARS-CoV-2. A Mutation creating the furin cleavage site in a precursor virus could be the key event leading to the emergence of SARS-CoV-2 virus and the pandemic.

Efforts by researchers to promote the acquisition of a complete furin cleavage site by limited serial passage in humanized mice have failed to show that propensity.<sup>1501</sup> Published research has demonstrated the ability to artificially insert a complete furin cleavage site in SARS and inserting a single amino acid into related alphacoronaviruses.<sup>1502</sup> Mutation studies in gammacoronavirus strains demonstrated the furin cleavage site was important in infectivity.<sup>1503</sup> Previous research demonstrated the ability to insert a complete furin cleavage site into the SARS virus.<sup>1504</sup> The 2018 EcoHealth DEFUSE proposal details the intent to insert human furin cleavage sites into prospective pandemic pathogens to assess their effect on transmissibility.<sup>1505</sup> Researchers demonstrated that the furin cleavage site in SARS-CoV-2 was essential to infect ferrets. SARS-CoV-2 studies that assessed variants where the furin cleavage site was removed, highlighted its significant contribution to infecting human lung cells and its potential contribution to virulence.<sup>1506,1507</sup> The origin of the furin cleavage site remains a significant unanswered question.

This investigation is aware of a yet unpublished Defense Advanced Research Projects Agency (DARPA) sponsored study evaluating the rate of recombination events among coronaviruses. The study evaluated the likelihood of recombination events in relation to the genetic and geographic distance between two different sarbeco-coronaviruses. While recombination is a common event among members of the coronavirus family, the frequency of the event decreases with increasing genetic distance. Nearly 90% of all recombination events occur between strains that are less than 20% divergent at the nucleotide level in the core genome. The published results of the recombination and geographic analysis are still pending at the time of this draft.

#### **b. Does the Early Outbreak Epidemiology Support the Occurrence of Two Discrete Emergences?**

As described by CCDC, the geo-temporal center of the initial outbreak was in Wuhan in Hubei province. As reported by the CCDC, the overall epidemiological curve shows a mixed outbreak pattern. “[T]he data appear to indicate a continuous common source pattern of spread in December [2019] and then from early January through February 11, 2020, the data appear to have a propagated source pattern.”<sup>1508</sup> The CCDC described that the early events were “consistent with the working theory that perhaps several zoonotic events occurred.”

Although, the possibility of two independent spillovers cannot be ruled out.<sup>1509</sup> The CCDC assessed the early Wuhan outbreak available epidemiology to be consistent with a continuous common source.<sup>1510</sup> This means that over a period of time extending beyond the incubation period, multiple people

were infected over time. This continuous common source cause of the COVID-19 outbreak in Wuhan is consistent with a resulted in seeding the virus in Wuhan and ultimately spread the virus to multiple locations around Wuhan during their period of infectivity. As described by the U.S. CDC in some common-source outbreaks, case-patients may have been exposed over a period of days, weeks, or longer. In a continuous common-source outbreak, the range of exposures and range of incubation periods tend to flatten and widen the peaks of the epidemic curve.<sup>1511</sup>

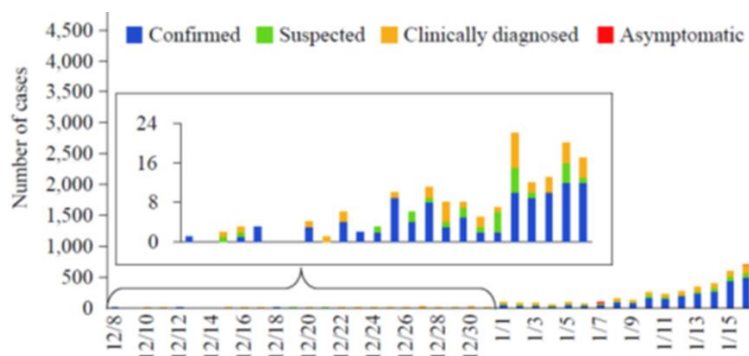

Figure 62. China CDC early Wuhan outbreak epidemic curve. Source: The Epidemiological Characteristics of an Outbreak of 2019 Novel Coronavirus Diseases (COVID-19) — China, 2020. Source: China CDC Weekly. 2020;2(8):113-122. <https://doi.org/10.46234/ccdcw2020.032>

Epidemiological and genetic molecular analyses of the early published circulating Wuhan SARS-CoV-2 strains supported the possibility of two spillover events two or more weeks apart.<sup>1512</sup> This assessment was made based on minor genetic differences in early circulating strains suggesting that two lineages of the same virus may have emerged simultaneously and progressed on different paths or sequentially separated by some period of time. One lineage showing more mutations than the other implying it had been circulated longer than the other or had potentially passed through more individuals.

Epidemiological modeling and reports of early COVID-19 cases converge on mid-October to mid-November, 2019 as the most likely timeframe for the spillover of SARS-CoV-2.<sup>1513</sup> Based on the publicly available evidence, it appears Wuhan is the only location where SARS-CoV-2 spilled over into humans.<sup>1514</sup> The low genetic diversity of earliest SARS-CoV-2 samples suggests that COVID-19 pandemic is most likely the result of one or possibly two successful introductions of SARS-CoV-2.<sup>1515,1516</sup> Additionally, these estimates indicate that the initial introduction may have occurred on or about November 18 and a second within weeks of the first.<sup>1517</sup>

A recently published study analyzed data from existing WHO global influenza surveillance networks early in the COVID-19 pandemic. Their analysis could identify outliers in influenza-negative influenza-like illness (ILI) that served as potential early indicator of COVID-19 community transmission.<sup>1518</sup> Their analysis of 28 countries' ILI surveillance data over a four-year period (2015-2019) identified outlier peaks of ILI in 2020 that occurred in on average 13.3 weeks before the occurrence of peak COVID-19 incidence in those countries.

A noticeable increase of Wuhan adult ILI cases during week 46 (November 11-17, 2019) corresponded to negative influenza testing that same week. This occurrence is similar to the

epidemiological outlier identified in the published study. It occurs approximately 13 weeks before the recorded surge of COVID-19 cases in Wuhan in late January, early February 2020.

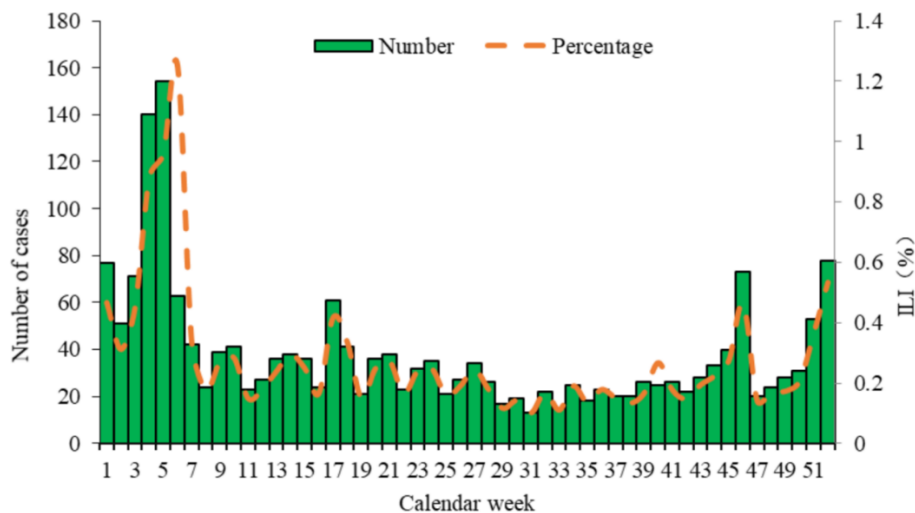

Figure 63. Weekly number of ILI cases in adults in the sentinel surveillance in Wuhan in 2019 (and percentage of outpatient visits categorized as ILI, [ILI %]). Source: WHO-convened global study of origins of SARS-CoV-2: China Part <https://www.who.int/publications/i/item/who-convened-global-study-of-origins-of-sars-cov-2-china-part>

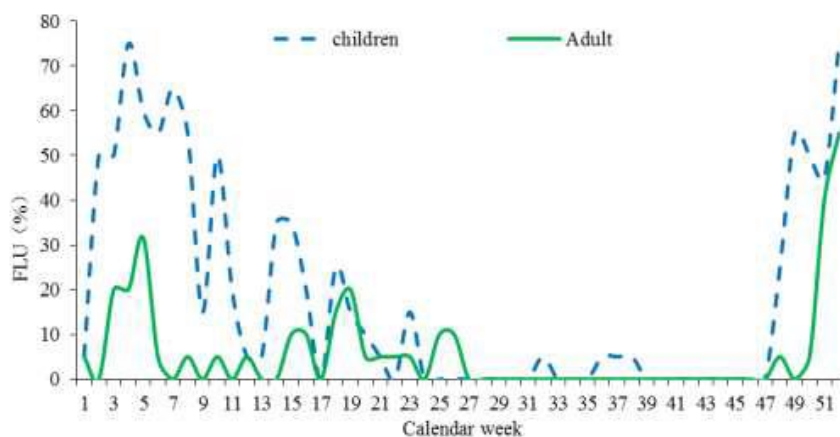

Figure 64. Weekly percentage of ILI cases with laboratory-confirmed influenza [FLU %] in the sentinel surveillance in children and adults in Wuhan in 2019. Source: WHO-convened global study of origins of SARS-CoV-2: China Part <https://www.who.int/publications/i/item/who-convened-global-study-of-origins-of-sars-cov-2-china-part>

Review of ILI data provided by China to the WHO as part of their joint investigation indicates most of the ILI cases reported in Wuhan beginning in week 48 were in children (Figure. 55). The number of cases of children increased rapidly from week 47. The number of ILI cases reported in adults was considerably lower than that reported in children. An increase in the number of cases in adults was seen during Week 46. This rise was noted in by the WHO SAGO report in June 2022. As written, the SAGO was “awaiting further details on the unexplained increase in ILI in adults from Wuhan the 46th week of 2019.”

While the CCDC published epidemiology describes the outbreak likely beginning on December 8, 2019, there is ample evidence to indicate SARS-CoV-2 emerged earlier. COVID-19 cases reported by China media outlets, US Government declassified intelligence reports and Government of China confirmed cases of illness in foreign visitors beginning in early to mid-November. These cases comport with epidemiological and molecular aging modeling that the COVID outbreak began in mid- to late October or early November 2019. The published NHC data showing a significant spike of ILI cases in the November to December 2019 timeframe deserve further evaluation to determine whether that did represent the earliest indicator of community transmission of SARS-CoV-2. The magnitude of this reported spike in incidence of ILI, approximately 1.2 million cases, if centered in Wuhan would represent roughly one tenth of the city's 11 million population.

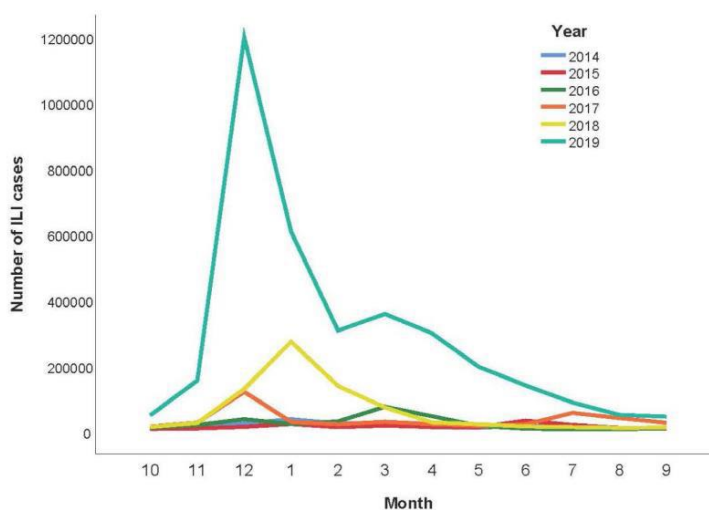

Figure 65. Reported influenza-like illness (ILI) cases during 2015–2019: Comparison of monthly reported ILI cases in different years. Source: <https://doi.org/10.1371/journal.pntd.0008758>

Chinese social media requests for medical assistance for symptoms related to COVID-19 in later December to mid- to late January occur in Wuhan in closer proximity to the WIV's Xiaoshonghan and Wuhan University Animal Institute of Model Animals campuses. This study comports with the timing of SARS-CoV-2 emergence and the intensity of later medical requests around the Huanan market in late January. Does it, however, support the potential for research-related incident (infected researcher) or zoonotic spillover (infected animal) as the potential source of the SARS-CoV-2 introduction?<sup>1519</sup>



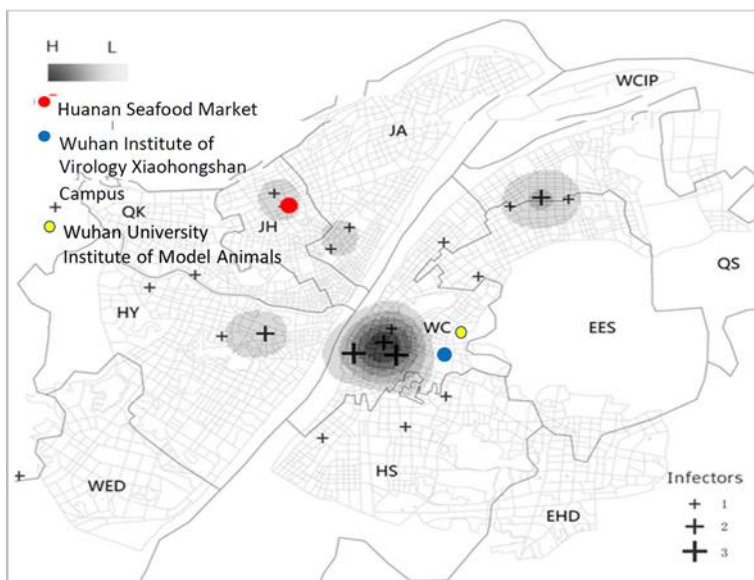

Figure 66. Chinese social media Begins to See an Increase in Requests for Help for Medical Treatments in Wuhan Spatial distribution of social media searches matching COVID-19 symptoms from December 20, 2019, to January 18, 2020. Source: Peng, Z., Wang, R., Liu, L., & Wu, H. (2020). *Exploring Urban Spatial Features of COVID-19 Transmission in Wuhan Based on Social Media Data*. *ISPRS International Journal of Geo-Information*, 9(6), 402. <https://doi.org/10.3390/ijgi9060402>

**c. Do Contemporaneous Remedial Biosafety-Related Activities to the Outbreak’s Initial Emergence Support a Research-related Incident(s)?**

The described epidemiology of the outbreak in early to mid-November (Week 46) 2019 coincides temporally with a series of potential remedial and response activities suggesting a possible research-related incident. In addition to several patents submitted in November and December 2019, there was a short notice procurement for an air incinerator to address some issue or failure of a biosafety autoclave. The need to add air incineration to the autoclave exhaust after serial HEPA filtration suggests the potential risk of an infectious aerosol escape.

This initiation of this remedial action occurs simultaneously with the arrival of a senior CAS biosecurity/biosafety official from Beijing. While his comments to the WIV leadership on November 19, 2019, are not entirely known, his comments reflected the concern and direction of senior CCP officials including Xi Jinping concerning biosecurity work at the WIV. The comments by the WIV’s Deputy Director of Biosafety are more revealing as they describe a series of biosafety related incidents occurring in the previous twelve months and highlight specific concerns about hidden safety dangers.

The senior CAS official’s appearance on November 19 is followed the next day by his participation in a two- and half-day biosafety and biosecurity training session for WIV researchers and Wuhan University students. His visit was followed two weeks later by a visit by the Vice Governor of Hubei province inspecting the WIV.

A subsequent WIV patent in December addresses the possible filtration failure of an animal transport cabinet. This additional corrective action highlights a possible second biosafety/biocontainment

incident. The timing of this corrective action again is in the timeframe when the COVID-19 outbreak is in its early stages according to data provided by the CCDC. Whether this action is possibly coincident with and a consequence of SARS-CoV-2 animal testing at the WIV or possibly the Wuhan University Institute of Animal Testing is not known.

**d. Two Plausible Scenarios of Research-related Incidents and Potential Researcher Infection.**

Respiratory viruses such as SARS-CoV-2 present a significant risk in experimental settings whenever infectious aerosols are created.<sup>1520</sup> Based on the WIV's experiments and biosafety and biosecurity concerns, this investigation believes the most likely research-related incident is an undetected aerosol leak causing an infection of WIV personnel or the release of infectious virus into the outside environment due to a failure of biocontainment. These kinds of incidents are most common and often not determined even after extensive investigation. The nature of this risk was noted by WIV BSL-4 researchers in a November 12, 2019 internal report: "Once you have opened the stored test tubes, it is just as if having opened Pandora's Box. These viruses come without a shadow and leave without a trace."<sup>1521</sup> Under what circumstances such an aerosol exposure may have occurred was not determined by this investigation. Two of the outlined hypotheticals figure prominently.

**i. Infection During Early Isolation/Characterization of Unknown Coronavirus**

The WIV conducted recombinant research creating infectious chimeric SARS-related viruses in BSL-2. BSL-2 does not require the use of more sophisticated and effective respiratory protection found in higher BSL levels, such as powered air purified respirator (PAPR) systems, exhaust HEPA filters, and effluent decontamination systems.<sup>1522</sup> Procedures such as isolating a virus using a centrifuge in BSL-2 settings can result in hazardous infectious aerosols and surface contamination.<sup>1523</sup> As of May 2019, a CCDC biosafety expert expressed concern about China's lack of national BSL-2 regulations, recommending "[m]anipulation of highly pathogenic microorganisms should be performed in high-level biosafety laboratories namely BSL-3 or BSL-4."<sup>1524</sup>

This scenario is that a research-related incident occurred sometime before September 2019. This infection, while unlikely to have caused the COVID-19 pandemic, may have spurred the WIV and PRC government to undertake precautionary actions identified by this investigation and others. The WIV took its viral database offline on September 12, 2019.<sup>1525</sup> The Wuhan municipal government issued its healthcare preparedness memorandum on September 17, 2019.<sup>1526</sup> An emergency drill at Wuhan's international airport simulating the discovery of an arriving passenger infected with a coronavirus was held on September 18, 2019.<sup>1527</sup> Local Wuhan area government entities also began increasing PCR purchases in September 2019.<sup>1528</sup> At the national level, the PRC central government started reducing exports of PPE and raw materials required to manufacture PPE and launched an investigation into the WIV's parent agency, the CAS.<sup>1529</sup>

The November 12, 2019, internal report further described the challenges confronted by WIV researchers leading to the possibility of more than one research-related incident. Beyond stressing the lack of equipment, technology standards, and experience, the report goes on to indicate incidents involving

“high pathogens” requiring a response from the BSL-4 team had occurred. This suggests the incidents were less likely to happen in BSL-4 laboratories than BSL-2 or BSL-3 facilities. Moreover, the large-scale HVAC renovation at the WIV’s BSL-4 facility started on September 12, 2019, and was scheduled to take 210 days, meaning that the BSL-4 was not operational when SARS-CoV-2 likely emerged.<sup>1530</sup>

## ii. Human Infection(s) from Exposure During Animal Experiment

In addition to conducting coronavirus cell culture work in BSL-2 settings, the WIV also conducted humanized mice experiments to assess the pandemic potential of SARS-related viruses.<sup>1531,1532</sup> They also tested the efficacy of vaccines in these mice and other animal species.<sup>1533,1534</sup> These animal experiments generate highly infectious aerosols that are “ubiquitous... and...difficult to detect.”<sup>1535</sup> Animal experiments with SARS-related viruses must be conducted at least in BSL-3/ABSL-3 settings in China, according to Wuhan University scientists.<sup>1536</sup>

Patents by WIV researchers published in 2018, 2019, and 2020 and WIV-related procurements in 2019 indicate that the institute struggled to maintain key biosafety capabilities at its high-containment BSL-3 and BSL-4 laboratories.<sup>1537, 1538, 1539, 1540</sup> Patents addressed biocontainment faults with animal transfer cabinets, biosafety autoclaves, leaky airtight doors, and excessive corrosive disinfectants affecting stainless steel laboratory equipment and biocontainment structures.<sup>1541,1542,1543</sup> Procurements included a large-scale HVAC renovation beginning in September 2019 at the BSL-4 laboratory of the WIV’s new Zhengdian campus and a sole-sourced, short suspense procurement on November 19, 2019 for an air incinerator to sterilize exhaust air from a biosafety autoclave at the WIV’s original Xiaohongshan downtown Wuhan campus.<sup>1544</sup> In short, the WIV was attempting to remedy its biosafety problems at the same time its researchers were conducting experiments on infectious SARS-related viruses they believed were at “high-risk” of spilling over into humans and causing a pandemic.<sup>1545</sup>

If the research-related incident(s) happened in mid- to late October and were discovered shortly after it occurred; the November 12, 2019 report from the WIV’s BSL-4 community party branch, the November 19, 2019 visit by the Beijing senior biosecurity official, the issuance of a short notice procurement for an air incinerator for a biosafety autoclave, and November 20-22, 2019 WIV remedial biosafety training sessions may be a response to an incident. The November 7 and 15, 2019 inaccurate and possibly deceptive media reporting about the Wuhan University Institute of Animal Models also raises the possibility of SARS-related non-human primate vaccine testing in that timeframe.

If the spillover occurred in mid- to late October, it may also have been possible for China to have launched its COVID-19 vaccine program in November, 2019. This sub-hypothesis requires WIV officials, local Wuhan government agencies, and the central government to have responded quickly within several days or a couple of weeks and in a coordinated fashion in response to a research-related incident.

The circumstances surrounding the development of the COVID-19 vaccine candidate by the AMMS team led by Professor Yusen Zhou is an area of unresolved concern. Zhou, was an accomplished coronavirus vaccinologist, who collaborated and published with WIV scientists on MERS and SARS vaccine research most recently in November 2019.<sup>1546</sup> Zhou’s team filed the first sub-unit patent for a COVID-19 vaccine with mouse data on February 24, 2020.<sup>1547</sup> Data contained in that patent and studies

Zhou published early in the pandemic would indicate that he performed studies with two types of infected mice (BALB/c (wild-type) and humanized) and non-human primates including vaccine challenge studies.<sup>1548</sup>

Based on interviews with U.S. and Operation Warp Speed (OWS) vaccine developers, this investigation estimates that the effort detailed in the Zhou patent represents at least two to three months of vaccine development work.<sup>1549,1550,1551</sup> It is also plausible that China's COVID-19 vaccine development program may have started earlier than November. Supporting a November 2019 start date is vaccine development by a WIV team in early 2020. They constructed a COVID-19 vaccine candidate based on the same technical approach as Zhou. Their effort took three months to develop and begin testing their vaccine candidate in mice.<sup>1552</sup> As a result it appears that Zhou's AMMS team began developing its COVID-19 vaccine candidate no later than November, 2019 about the same time the other AMMS team's began development of their adenovirus vaccine candidate.

This investigation could not determine where the Zhou AMMS team conducted its animal vaccine challenge studies.<sup>1553,1554</sup> A study submitted by Zhou in May 2020 states that he conducted some of the mouse vaccine studies in AMMS BSL-3 rather than ABSL-3 laboratories.<sup>1555</sup> BSL-3 facilities are inadequate to conduct such hazardous animal vaccine experiments.<sup>1556</sup> The fact that non-human primates were also part of Zhou's vaccine challenge studies likely precludes AMMS facilities that have not published non-human primate vaccine challenge studies. China's biosafety and biosecurity regulations specify that this work should be done in ABSL-3 settings or higher.

The HVAC renovation at the Zhengdian campus awarded in September 2019, may have precluded using laboratories there for such studies. Also, the WIV's BSL-3 and ABSL-3 laboratories at Zhengdian were reportedly not or just initially operational at that time. In lieu of the availability of WIV's Zhengdian BSL-4 or BSL-3/ABSL-3 laboratories, the WIV's Xiaohongshan BSL-3/ABSL-3 laboratories would be a logical alternative to conduct mouse vaccine studies.

The Wuhan University Institute of Animal Models had previously conducted published SARS vaccine challenge studies in Rhesus monkeys.<sup>1557, 1558</sup> The Institute is within a mile of the WIV Xiaohongshan campus. Whether this proximate location, with state-of-the-art facilities and experienced workers offered a potential collaborative center that Zhou used remains unknown.<sup>1559</sup>

The other AMMS vaccine development team led by Major General Chen performed animal (mice, ferret and non-human primates) vaccine challenge studies at the Harbin BSL-4 high-containment laboratory. Another early COVID-19 vaccine candidate developed by the CCDC and CAS conducted animal challenge studies including non-human primate studies at the Kunming BSL-4 high-containment laboratory.<sup>1560</sup>

The WIV's BSL-4 laboratory is the only such level facility in China that appears not to have had a candidate COVID-19 vaccine under development in late 2019 or early 2020. An April 2020 submitted WIV vaccine challenge study on a candidate COVID-19 vaccine in non-human primates was performed at Guangzhou Institutes of Biomedicine and Health rather than at the WIV's ABSL-3 or 4 facilities or the Wuhan University's Institute of Animal Models.<sup>1561</sup>

Given Zhou's past collaboration with the WIV, this investigation believes that his AMMS team may have conducted their animal vaccine trial studies in the WIV's BSL/ABSL-3 facilities at its Xiaohongshan campus in central Wuhan. There is also the possibility that Zhou conducted non-human primate vaccine related studies at the Wuhan University's Institute of Animal Models where previous SARS-related vaccine research was performed.<sup>1562</sup> If the Zhou AMMS team began vaccine development in earlier in the Fall, it is plausible that animal infection and challenge studies were underway in early to mid-November 2019. This investigation is concerned that these animal vaccine challenge experiments if conducted in the WIV's ABSL-3 facility and associated BSL-3 laboratories under inadequate biosafety containment conditions may be the proximate cause of the initial outbreak in Wuhan.

Adding to the uncertainties surrounding Zhou's work at the WIV, are the circumstances around his apparent death. He died sometime after submitting the preprint of his study adapting SARS-CoV-2 to BALB/c mice and the initial testing of his candidate vaccine in early May 2020 and its publication in July 2020.<sup>1563,1564</sup> There was no official PRC government acknowledgement of his death. Further, mention of his vaccine candidate or evidence it advanced in development was not included in any publications reviewing COVID-19 vaccines being developed in China during the pandemic.<sup>1565,1566,1567,1568,1569,1570</sup>

This investigation focused on the question of the origins of the pandemic. It could not determine whether the SARS-CoV-2 virus was a product of nature alone or possible genetic manipulation. The preponderance of information affirms the plausibility of a research-related incident that was likely unintentional resulting from failures of biosafety containment during vaccine-related research. The nature of the identified biosafety vulnerabilities increased the likelihood that such containment failures were not immediately recognized. The possibility of unrecognized biocontainment breaches combined with SARS-CoV-2 clinical characteristics of asymptomatic infection and mild clinical illness in the majority of infections likely confounded early recognition and containment of the initial outbreak. Such initial unrecognized infections could serve as the nidus of the outbreak of COVID-19 in Wuhan and is a plausible proximate cause of the pandemic.

## ENDNOTES

- <sup>1</sup> Tan, C.C.S., Lam, S.D., Richard, D. *et al.* (2022). Transmission of SARS-CoV-2 from humans to animals and potential host adaptation. *Nat Commun* **13**, 2988 (2022). <https://doi.org/10.1038/s41467-022-30698-6>
- <sup>2</sup> WHO Scientific Advisory Group for the Origins of Novel Pathogens (SAGO): preliminary report, (2022). Geneva: World Health Organization; <https://cdn.who.int/media/docs/default-source/scientific-advisory-group-on-the-origins-of-novel-pathogens/sago-report-09062022.pdf>
- <sup>3</sup> *Id.*
- <sup>4</sup> *Id.*
- <sup>5</sup> Pekar, Jonathan, Michael Worobey, Niema Moshiri, Konrad Scheffler, and Joel O. Wertheim. (2021). Timing the SARS-CoV-2 index case in Hubei province. *Science* **372**, no. 6540: 412-417; *see also* Roberts, David L., Jeremy S. Rossman, and Ivan Jarić. (2021). Dating first cases of COVID-19. *PLoS pathogens* **17**, no. 6: e1009620.
- <sup>145</sup> WHO-convened global study of origins of SARS-CoV-2: China Part. [www.who.int](http://www.who.int). Published March 30, 2021. <https://www.who.int/publications/i/item/who-convened-global-study-of-origins-of-sars-cov-2-china-part>
- <sup>7</sup> WHO Scientific Advisory Group for the Origins of Novel Pathogens (SAGO): preliminary report, (2022). Geneva: World Health Organization; <https://cdn.who.int/media/docs/default-source/scientific-advisory-group-on-the-origins-of-novel-pathogens/sago-report-09062022.pdf>
- <sup>8</sup> Dai, Y., & Wang, J. (2020). Identifying the outbreak signal of COVID-19 before the response of the traditional disease monitoring system. *PLoS neglected tropical diseases*, **14**(10), e0008758. <https://doi.org/10.1371/journal.pntd.0008758>
- <sup>9</sup> *Id.*
- <sup>10</sup> *Id.*
- <sup>11</sup> Cobb NL, Collier S, Attia EF, Augusto O, West TE, Wagenaar BH (2022) Global influenza surveillance systems to detect the spread of influenza-negative influenza-like illness during the COVID-19 pandemic: Time series outlier analyses from 2015–2020. *PLoS Med* **19**(7): e1004035. <https://doi.org/10.1371/journal.pmed.1004035>
- <sup>12</sup> Westergard R. (2020). Surviving the Outbreak: Reflections on ConGen Wuhan’s Evacuation and Life in Quarantine. *State Magazine*. <https://statemag.state.gov/2020/04/0420feat05/>.
- <sup>13</sup> The Office of the Spokesperson of the U.S. Department of State. (Jan. 15, 2021). Fact Sheet: Activity at the Wuhan Institute of Virology. U.S. Department of State. <https://2017-2021.state.gov/fact-sheet-activity-at-the-wuhan-institute-of-virology/index.html>
- <sup>14</sup> Virginia L. Ma & Meera S. Nair. (Jun. 12, 2020). Coronavirus May Have Spread in China Last August, Preliminary Harvard Study Suggests. *The Harvard Crimson*. <https://www.thecrimson.com/article/2020/6/12/coronavirus-satellite-research/>. *See also*: John S. Brownstein, et al. (2020). Analysis of Hospital Traffic and Search Engine data in Wuhan China Indicates Early Disease Activity in the Fall of 2019. *Harvard Library*. <http://nrs.harvard.edu/urn-3:HUL.InstRepos:42669767/>.
- <sup>15</sup> *Id.*
- <sup>16</sup> *Id.*
- <sup>17</sup> John Sexton. (Aug. 23, 2021). Josh Rogin: The Sick Researchers from the Wuhan Institute of Virology Lost their Sense of Smell. *Hot Air*; *see also* Honestly with Bari Weiss. (Aug. 23, 2021). You're Already Living in China's World Pt 1: The Lab Leak Lies. *Apple Podcasts* (Online).
- <sup>18</sup> Updated Assessment on COVID-19 Origins Key Takeaways. <https://www.dni.gov/files/ODNI/documents/assessments/Declassified-Assessment-on-COVID-19-Origins.pdf>
- <sup>19</sup> Markson S. (2021). What Really Happened in Wuhan: A Virus like No Other, Countless Infections, Millions of Deaths. *Harpercollins Publishers Australia Pty Limited*.
- <sup>20</sup> *Id.*
- <sup>21</sup> Ian Birrell. (2021). Is ‘Patient Su’ Covid’s Patient Zero?. *The Daily Mail*. <https://www.hindustantimes.com/world-news/is-wuhan-s-patient-su-covid-s-patient-zero-report-reveals-new-timeline-of-infection-101622360922716.html>.
- <sup>22</sup> 专家研判新冠源头：去年 12 月 8 日或许不是最早发病时间. [www.guancha.cn](http://www.guancha.cn). Experts judge the source of the new crown [coronavirus]: December 8 last year [2019] may not be the earliest time of onset. (February 27, 2020). [https://www.guancha.cn/politics/2020\\_02\\_27\\_538822.shtml](https://www.guancha.cn/politics/2020_02_27_538822.shtml)

- <sup>23</sup> He J. (2020). The outbreak of the outbreak of the official letter leaked several months earlier than the CCP announced. Epoch Times. <https://www.epochtimes.com/gb/20/10/8/n12462796.htm>
- <sup>24</sup> Mier T. (2020). 1<sup>st</sup> virus cases months earlier claimed. NTD News. [https://www.youtube.com/watch?v=VfoRGG\\_j5x4](https://www.youtube.com/watch?v=VfoRGG_j5x4)
- <sup>25</sup> Ma J. (2020). Coronavirus: China's First Confirmed Covid-19 Case Traced Back to November 17. South China Morning Post. <https://www.scmp.com/news/china/society/article/3074991/coronavirus-chinas-first-confirmed-covid-19-case-traced-back>.
- <sup>26</sup> Reed C. (2020). What it's REALLY like to catch coronavirus: First British victim, 25, describes how 'worst disease he ever had' left him sweating, shivering, and struggling to breathe as his eyes burned and bones ached. The Daily Mail. <https://www.dailymail.co.uk/news/article-8075633/First-British-victim-25-describes-coronavirus.html> ; see also Ben Dangerfield. (2020). Briton Struck with Coronavirus in Wuhan Recalls: 'I Couldn't Get Enough Air'. Reuters. <https://www.reuters.com/article/us-health-coronavirus-wuhan-britain/briton-struck-with-coronavirus-in-wuhan-recalls-i-couldnt-get-enough-air-idUSKBN20Y22F>
- <sup>27</sup> *Id.*
- <sup>28</sup> For example, see Ye ZW, Yuan S, Yuen KS, Fung SY, Chan CP, Jin DY. (2020). Zoonotic origins of human coronaviruses. *Int J Biol Sci.* 16(10):1686-1697. <https://doi.org/10.7150/ijbs.45472> “Phylogenetic evidence has shown that bats and rodents serve as the gene source of most alpha-CoVs and beta-CoVs, while birds are the main reservoir of gamma-CoVs and delta-CoVs.” Also, “[p]hylogenetic evidence indicated that both HCoV-NL63 and HCoV-229E might have originated from bat CoVs 62-64, while the parental viruses of HCoV-OC43 and HCoV-HKU1 have been found in rodents.”
- <sup>29</sup> See Pike BL, Saylor KE, Fair JN, et al. (2010). The origin and prevention of pandemics. *Clin Infect Dis.* 50(12):1636-1640. <https://doi.org/10.1086/652860> , “In a serological survey of >1000 rural Cameroonian villagers with reported exposure to primates, we found that 1% had antibodies to simian foamy virus, suggesting that populations exposed to animal reservoirs of disease are constantly assailed by zoonotic agents. Presumably, the likelihood of any one zoonotic agent becoming a human pathogen is dependent upon a number of factors. Multiple introductions into the human population may be necessary before a zoonotic agent establishes itself as a human pathogen and the determinants of cross-species tropism are still ill defined, as are the factors that influence whether infection causes disease.”
- <sup>30</sup> See Pike BL, Saylor KE, Fair JN, et al. The origin and prevention of pandemics. *Clin Infect Dis.* 2010;50(12):1636-1640. doi:10.1086/652860, “For instance, among central Africans reporting contact with nonhuman primate blood and body fluids through hunting, butchering, and keeping primate pets, we identified a wide array of primate T lymphotropic viruses....”
- <sup>31</sup> Wang, L. F., & Eaton, B. T. (2007). Bats, civets and the emergence of SARS. *Current topics in microbiology and immunology*, 315, 325–344. [https://doi.org/10.1007/978-3-540-70962-6\\_13](https://doi.org/10.1007/978-3-540-70962-6_13)
- <sup>32</sup> Liu, W. J., Liu, P., Lei, W., Jia, Z., He, X., Shi, W., Tan, Y., Zou, S., Wong, G., Wang, J., Wang, F., Wang, G., Qin, K., Gao, R., Zhang, J., Li, M., Xiao, W., Guo, Y., Xu, Z., Zhao, Y., ... Wu, G. (2023). Surveillance of SARS-CoV-2 at the Huanan Seafood Market. *Nature*, 10.1038/s41586-023-06043-2. Advance online publication. <https://doi.org/10.1038/s41586-023-06043-2>
- <sup>33</sup> Butler D. (2013). Mapping the H7N9 avian flu outbreaks. *Nature*. <https://doi.org/10.1038/nature.2013.12863> [https://web.archive.org/web/20140202105711/http://www.wpro.who.int/outbreaks\\_emergencies/H7N9/en/index.html](https://web.archive.org/web/20140202105711/http://www.wpro.who.int/outbreaks_emergencies/H7N9/en/index.html)
- <sup>34</sup> Worobey M, Levy JI, Malpica Serrano L., et. al. (2022). The Huanan Seafood Wholesale Market in Wuhan was the early epicenter of the COVID-19 pandemic. *Science*. 377(6609):951-959. <https://doi.org/10.1126/science.abp8715>
- <sup>35</sup> Cohen, J. (2022). “Anywhere But Here.” *Science*. 377: 6608. <https://www.science.org/content/article/pandemic-start-anywhere-but-here-argue-papers-chinese-scientists-echoing-party-line>
- <sup>36</sup> Rigby, J., Tetrault-Fraber, G. (2023). WHO says China data underrepresents COVID surge and deaths. Reuters. <https://www.reuters.com/world/china/whos-tedros-concerned-by-china-covid-surge-calls-again-data-2023-01-04/>
- <sup>37</sup> World Health Organization Scientific Advisory Group for the Origins of Novel Pathogens (SAGO). (2022). Preliminary Report. [SAGO Preliminary Report \(who.int\)](https://www.who.int/publications/m/item/sago-preliminary-report)
- <sup>38</sup> Zimmer C., Mueller, B. (2022). New research points to Wuhan market pandemic origin. *NY Times*. <https://www.nytimes.com/interactive/2022/02/26/science/covid-virus-wuhan-origins.html>

- <sup>39</sup> Gao, G., Liu, W., Liu, P., Lei, W., Jia, Z., He X., Liu, L-L. Shi, W., Tan, Y., Zou, S., Zhao, X., Wong, G., Wang, J., Wang, F., Wang, G., Qin, K., Gao, R-b., Zhang, J., Li, M., Wu, G. (Feb. 25, 2022). Surveillance of SARS-CoV-2 in the environment and animal samples of the Huanan Seafood Market. Research Square. <https://doi.org/10.21203/rs.3.rs-1370392/v1>.
- <sup>40</sup> Shi, Z., & Hu, Z. (2008). A review of studies on animal reservoirs of the SARS coronavirus. *Virus research*, 133(1), 74–87. <https://doi.org/10.1016/j.virusres.2007.03.012>
- <sup>41</sup> Wolters, W. J., de Rooij, M. M. T., Molenaar, R. J., de Rond, J., Vernooij, J. C. M., Meijer, P. A., Oude Munnink, B. B., Sikkema, R. S., van der Spek, A. N., Spierenburg, M. A. H., Hakze-van der Honing, R. W., van der Poel, W. H. M., Koopmans, M. P. G., Stegeman, J. A., Smit, L. A. M., Augustijn-Schretlen, M., & Velkers, F. C. (2022). Manifestation of SARS-CoV-2 Infections in Mink Related to Host-, Virus- and Farm-Associated Factors, The Netherlands 2020. *Viruses*, 14(8), 1754. <https://doi.org/10.3390/v14081754>
- <sup>42</sup> World Health Organization Scientific Advisory Group for the Origins of Novel Pathogens (SAGO). (2022). Preliminary Report. [SAGO Preliminary Report \(who.int\)](https://www.who.int/publications/i/item/sago-preliminary-report)
- <sup>43</sup> World Health Organization. (2021). “WHO-convened global study of origins of SARS-CoV-2: China Part”. <https://www.who.int/publications/i/item/who-convened-global-study-of-origins-of-sars-cov-2-china-part> .
- <sup>44</sup> Worobey, M., Levy, J.I., Malpica-Serrano L, et al. (2022). The Huanan Seafood Wholesale Market in Wuhan was the early epicenter of the COVID-19 pandemic. *Science*. 377(6609):951-959. <https://doi.org/10.1126/science.abp8715>
- <sup>45</sup> Mallapaty S. (2023). COVID-origins study links raccoon dogs to Wuhan market: what scientists think. *Nature*, 10.1038/d41586-023-00827-2. Advance online publication. <https://doi.org/10.1038/d41586-023-00827-2>
- <sup>46</sup> Na, L., Hu, L., Jin, A., Li, J. Biosafety laboratory risk assessment. *Journal of Biosafety and Biosecurity*. 2019. 1; 90-92. <http://creativecommons.org/licenses/by-nc-nd/4.0/>
- <sup>47</sup> Pike, R.M. (1979). Laboratory-Associated Infections: Incidence, Fatalities, Causes and Prevention. *Ann. Rev. Microbial*. 33:41-66.
- <sup>48</sup> Pike, R.M. (1976). Laboratory-acquired infections: summary and analysis of 3921 cases. *Health Lab Sci*. 13(2):105-114. <https://pubmed.ncbi.nlm.nih.gov/946794/>
- <sup>49</sup> Phillips, G.B. (1965). Causal Factors of Microbiological Laboratory Accidents. Miscellaneous Publications. US Army Biological Laboratories, Fort Detrick.
- <sup>50</sup> *Id.*
- <sup>51</sup> Harding, L., Brandt-Byers, K. (2006). Epidemiology of laboratory-acquired infections. *Biological Safety: Principles and Practice* 4<sup>th</sup> edition. <https://doi.org/10.1128/9781555815899.ch4>
- <sup>52</sup> Martin, J.C. (1980). Behavior factors in laboratory safety: personnel characteristics and modifications of unsafe act. *Laboratory Safety: Theory and Practice*. Academic Press New York, NY.
- <sup>53</sup> Li, J., et al., “Biosafety Laboratory Risk Assessment,” *Journal of Biosafety and Biosecurity* (Volume 1, Issue 2), September 2019, available online 20 February 2019, p. 91. <https://www.sciencedirect.com/science/article/pii/S2588933818300165#:~:text=https%3A//doi.org/10.1016/j.jobb.2019.01.011>
- <sup>54</sup> Zhang, Z., Wu, J., Hao, L., Yi, Y., Qi, J. (2020). Development of biosafety equipment for high containment laboratory and for personal protection in China. *Biosafety and Health*. Vol 2: 1. 12-17. <https://doi.org/10.1016/j.bsheal.2019.12.008>
- <sup>55</sup> *Id.*
- <sup>56</sup> Wu, G. (2019). Laboratory biosafety in China: past, present, and future. *Biosafety and health*, 1(2), 56–58. <https://doi.org/10.1016/j.bsheal.2019.10.003>
- <sup>57</sup> *Id.*
- <sup>58</sup> Declan, B. (2015). “Engineered Bat Virus Stirs Debate over Risky Research,” *Nature*. <https://doi.org/10.1038/nature.2015.18787>
- <sup>59</sup> Cyranoski, D. (2017) “Inside the Chinese Lab Poised to Study the World’s Most Dangerous Pathogens,” *Nature* 542, pages 399–400 <https://doi.org/10.1038/nature.2017.21487>. For more detailed information on the history of lab leaks in China, see Chapter 7 of this report.
- <sup>60</sup> *Id.*
- <sup>61</sup> Rogin, J. (2020). State Department cables warned of safety issues at Wuhan lab studying bat coronaviruses. The Washington Post. <https://www.washingtonpost.com/opinions/2020/04/14/state-department-cables-warned-safety-issues-wuhan-lab-studying-bat-coronaviruses/>



<sup>62</sup> *Id.*

<sup>63</sup> Gao, G.F. (2019). “For a Better World: Biosafety Strategies to Protect Global Health,” *Biosafety and Health* 1 (1) p. 2. Gao’s comments were also reported in “The Origins of Covid-19: An Investigation of the Wuhan Institute of Virology,” House Foreign Affairs Committee Report Minority Staff, August 2021, p. 18.

<sup>64</sup> Zhiming, Y. Current status and future challenges of high-level biosafety laboratories in China. *Journal of Biosafety and Biosecurity*. 2019 Sept;1(2): 123-127. [Current status and future challenges of high-level biosafety laboratories in China - PMC \(nih.gov\)](#)

<sup>65</sup> *Id.*

<sup>66</sup> “Wuhan Institute of Virology Convenes 2019 Security Work Conference” (武汉病毒所召开 2019 年度安全工作会议), *Wuhan Institute of Virology* (Online), 08 April 2019.

<sup>67</sup> *Id.* The quoted text is “研究所安全工作是研究所做好所有工作的前提和保障.” The safety work of the institute is the premise and guarantee for the institute to do all the work well

<sup>68</sup> *Id.* The quoted text is “她要求：一是要严格落实安全工作责任制，将安全管理工作与科研业务工作紧密结合，做到两者‘同计划，同部署，同检查，同总结，同评比’；二是实验室的各项操作必须严格遵照标准作业程序执行，不可存在任何侥幸心理；三是进一步加强学生安全管理。” “First, we should strictly implement the responsibility system of safety work, and closely integrate safety management with scientific research business work, so that both 'with planning, deployment, inspection, summary and evaluation'; second, the laboratory operations must strictly follow the standard operating procedures, and there should not be any fluke mentality; third, to further strengthen student safety management.” Translated with www.DeepL.com/Translator

<sup>69</sup> Wuhan Institute of Virology Patent. Biological safety laboratory exhaust system. Google Patents. 2019. <https://patent.google.com/patent/CN209960702U/en?assignee=Wuhan+Institute+of+virology+of+CAS&sort=new&page=11>

<sup>70</sup> Wuhan Institute of Virology. 2019. Patent:No. 201910325059.0 Biosafety autoclave and sterilization method. <https://patents.google.com/patent/CN210078382U/en?assignee=Wuhan+Institute+of+Virology+of+CAS&sort=new&page=12>

<sup>71</sup> Qui, J. (2022). Meet the scientist at the center of the covid lab leak controversy. MIT Technology Review. <https://www.technologyreview.com/2022/02/09/1044985/shi-zhengli-covid-lab-leak-wuhan/>

<sup>72</sup> DRASTIC Research Group, “An Investigation into the WIV Databases that were Taken Offline,” Research Gate (Online), February 2021, p. 7.

<sup>73</sup> See <https://docs.google.com/document/d/15U2uE7Eru0QxRbf8QVRPRMpsCoYhGvT/edit>

<sup>74</sup> Cohen J. Wuhan coronavirus hunter Shi Zhengli speaks out. (2020). *Science*. <https://doi.org/10.1126/science.abd9835>

<sup>75</sup> Zeng, L-P. Reverse Genetic System of Bat SARS-related coronaviruses and function of ORF3. 2017. Wuhan Institute of Virology, Chinese Academy of Sciences. 2018. Available at <https://docs.google.com/document/d/1uZrBG5A720aLgtVI4kPp6nJM7FuuolwO/edit>

<sup>76</sup> *Id.*

<sup>77</sup> Becker GL, Lu Y, Hards K, Strehlow B, Levesque C, Lindberg I, Sandvig K, Bakowsky U, Day R, Garten W, Steinmetzer T. (2012). Highly potent inhibitors of proprotein convertase furin as potential drugs for treatment of infectious diseases. *Journal of Biochemistry*. 287(26): 21992-22003. <https://doi.org/10.11074/jbc.M111.332643>

<sup>78</sup> Li, W., Wicht, O., van Kuppeveld, F. J., He, Q., Rottier, P. J., & Bosch, B. J. (2015). A Single Point Mutation Creating a Furin Cleavage Site in the Spike Protein Renders Porcine Epidemic Diarrhea Coronavirus Trypsin Independent for Cell Entry and Fusion. *Journal of virology*, 89(15), 8077–8081. <https://doi.org/10.1128/JVI.00356-15>

<sup>79</sup> EcoHealth Alliance. Draft Defense Advanced Research Projects Agency proposal. Project DEFUSE: Defusing the threat of bat-borne coronaviruses. March 2018. HR001118S0017-PREEMPT-PA 001

<sup>80</sup> *Id.*

<sup>81</sup> Peacock TP, Goldhill DH, Zhou J, et al. (2021). The furin cleavage site in the SARS-CoV-2 spike protein is required for transmission in ferrets. *Nature Microbiology*. Published online April 27, 2021:1-11. <https://doi.org/10.1038/s41564-021-00908-w>

<sup>82</sup> Johnson, B. A., Xie, X., Bailey, A. L., Kalveram, B., Lokugamage, K. G., Muruato, A., Zou, J., Zhang, X., Juelich, T., Smith, J. K., Zhang, L., Bopp, N., Schindewolf, C., Vu, M., Vanderheiden, A., Winkler, E. S., Swetnam, D., Plante, J. A., Aguilar, P., Plante, K. S., ... Menachery, V. D. (2021). Loss of furin cleavage site attenuates SARS-CoV-2 pathogenesis. *Nature*, 591(7849), 293–299. <https://doi.org/10.1038/s41586-021-03237-4>

- <sup>83</sup> Whittaker, G. R. (2021). SARS-CoV-2 spike and its adaptable furin cleavage site. *The Lancet. Microbe*, 2(10), e488–e489. [https://doi.org/10.1016/S2666-5247\(21\)00174-9](https://doi.org/10.1016/S2666-5247(21)00174-9)
- <sup>84</sup> Centers for Disease Control and Prevention & National Institutes of Health. (2020). Biosafety in Microbiological and Biomedical Laboratories (BMBL) 6th Edition. [https://www.cdc.gov/labs/pdf/SF\\_19\\_308133-A\\_BMBL6\\_00-BOOK-WEB-final-3.pdf](https://www.cdc.gov/labs/pdf/SF_19_308133-A_BMBL6_00-BOOK-WEB-final-3.pdf)
- <sup>85</sup> National Institutes of Health. (2019). NIH Guidelines for Research Involving Recombinant or Synthetic Nucleic Acid Molecules. [https://osp.od.nih.gov/wp-content/uploads/NIH\\_Guidelines.pdf](https://osp.od.nih.gov/wp-content/uploads/NIH_Guidelines.pdf)
- <sup>86</sup> Menachery, V., Yount, B., Debbink, K. *et al.* A SARS-like cluster of circulating bat coronaviruses shows potential for human emergence. *Nat Med* **21**, 1508–1513 (2015). <https://doi.org/10.1038/nm.398>
- <sup>87</sup> BurrNIH-00000514
- <sup>88</sup> Zeng, L-P. Reverse Genetic System of Bat SARS-like coronavirus and function of ORFX. 2017. Wuhan Institute of Virology, Chinese Academy of Sciences. 2018. Available at <https://docs.google.com/document/d/1uZrBG5A720aLGtVI4kPp6nJM7FuolwO/edit>
- <sup>89</sup> *Id.*
- <sup>90</sup> *Id.*
- <sup>91</sup> Reply to Science Magazine. <https://www.science.org/pb-assets/PDF/News%20PDFs/Shi%20Zhengli%20Q&A-1630433861.pdf>
- <sup>92</sup> *Id.*
- <sup>93</sup> Mention of humanized mice, bats and pangolins: Fact Sheet: Activity at the Wuhan Institute of Virology. United States Department of State. <https://2017-2021.state.gov/fact-sheet-activity-at-the-wuhan-institute-of-virology/index.html>
- <sup>94</sup> Mention of transgenic mice and civets: Reply to Science Magazine. <https://www.science.org/pb-assets/PDF/News%20PDFs/Shi%20Zhengli%20Q&A-1630433861.pdf>
- <sup>95</sup> Zhengli S., Cohen J. Wuhan coronavirus hunter Shi Zhengli speaks out. *Science*. 2020;369(6503):487-488. <https://doi.org/10.1126/science.369.6503.487> (written responses). <https://www.science.org/pb-assets/PDF/News%20PDFs/Shi%20Zhengli%20Q&A-1630433861.pdf>
- <sup>96</sup> BurrNIH-00000483-495.
- <sup>97</sup> Mention of transgenic mice and civets research: Reply to Science Magazine. <https://www.science.org/pb-assets/PDF/News%20PDFs/Shi%20Zhengli%20Q&A-1630433861.pdf>
- <sup>98</sup> B.L.S A. COVID-19: US NIH Partially Terminates Grant to EcoHealth Alliance – The Wire Science. Accessed October 10, 2022. <https://science.thewire.in/the-sciences/us-national-institute-of-health-terminates-grant-to-nonprofit-that-worked-with-wuhan-institute/>
- <sup>99</sup> “Wuhan Institute of Virology Holds 2019 Specialized Training on National Security”, *Wuhan Institute of Virology* (Online), 13 May 2019.
- <sup>100</sup> *For example, see* “Party Branch of the Wuhan Institute of Virology Microbiological Resources and Bioinformatics Research Center Organizes Monthly Party Day Activities and Specialized Investigation and Study of ‘Staying True to our Original Aspiration, Keeping Firmly in Mind our Mission’” Wuhan Institute of Virology (Online), 22 July 2019. *See also*, “Wuhan Institute of Virology Organizes Centralized Study on the Educational Theme of ‘Staying True to our Original Aspiration, Keeping Firmly in Mind our Mission’,” Wuhan Institute of Virology (Online), 09 July 2019.
- <sup>101</sup> Ai, H. (2019). “Testing Begins for Special Passage through Airport for Military World Games”, Hebei Daily reprinted by Xinhua (Online), 26 September 2019
- <sup>102</sup> *Id.*
- <sup>103</sup> Cao C. China's evolving biosafety/biosecurity legislations. *J Law Biosci*. 2021 Jun 30;8(1):lsab020. <https://doi.org/10.1093/jlb/lsab020>. PMID: 34221436; PMCID: PMC8245076. <https://academic.oup.com/jlb/article/8/1/lsab020/6311556>
- <sup>104</sup> *See*, “Keep Firmly in Mind Your Responsibilities, Hold Fast to the Mission, Be a Pioneer for our Nation in the Realm of High-Level Biosafety – The Achievements of the Zhengdian Lab Party Branch of the Chinese Academy of Sciences Wuhan Institute of Virology”, *Wuhan Institute of Virology* (Online), 12 November 2019.
- <sup>105</sup> *Id.*
- <sup>106</sup> *Id.*
- <sup>107</sup> Li W., Zhen W.J. (November 15, 2019). “Explore the Institute of Model Animals of Wuhan University, which used to be one of the battlefields against SARS. Chutian Metropolis Daily. [Exploring the Institute of Model Animals of Wuhan University, which used to be one of the battlefields to fight against SARS – yqqlm \(new-qq-](#)

[com.translate.goog](https://www.google.com.translate)) [Exploring the Institute of Model Animals of Wuhan University, which used to be one of the battlefields to fight against SARS – yqqlm \(new-yq-com.translate.goog\)](#)

<sup>108</sup> Luo, F., Liao, F. L., Wang, H., Tang, H. B., Yang, Z. Q., & Hou, W. (2018). Evaluation of Antibody-Dependent Enhancement of SARS-CoV Infection in Rhesus Macaques Immunized with an Inactivated SARS-CoV Vaccine. *Virologica Sinica*, 33(2), 201–204. <https://doi.org/10.1007/s12250-018-0009-2>

<sup>109</sup> See “Wuhan Institute of Virology Launches Training on Safety Work”, Wuhan Institute of Virology (Online), 21 November 2019.

<sup>110</sup> *Id.*

<sup>111</sup> *Id.*

<sup>112</sup> Wuhan Institute of Virology. 2019. Patent:No. 201910325059.0 Biosafety autoclave and sterilization method. <https://patents.google.com/patent/CN210078382U/en?assignee=Wuhan+Institute+of+Virology+of+CAS&sort=new&page=12>

<sup>113</sup> Tang, H., Yao, L., Wu, J., Li, L., Liu, J. Patent: A tourniquet-like instrument that is used in biological safety laboratory. CN1107555127A. November 15, 2019. <https://patents.google.com/patent/CN1107555127A/en?assignee=Wuhan+Institute+of+Virology+of+CAS&sort=new&page=8>

<sup>114</sup> Gao, D., Zhang, Q., Han, K., Qian, Q., Wenbo, A. Google Patent: Integrated Biological Sensor CN 201922213832.2. December 11, 2019. <https://patents.google.com/patent/CN211375358U/en?assignee=Wuhan+Institute+of+Virology+of+CAS&sort=new&page=8>

<sup>115</sup> Jia W, Zhiming Y, Hao T, Jun L, Hao Q, Yi L, Lin W. (2020). Google Patents. Object surface disinfectant for high-grade biosafety laboratory and preparation method thereof. <https://patents.google.com/patent/CN112262846B/en?assignee=Wuhan+Institute+of+Virology+of+CAS&sort=new&page=5>

<sup>116</sup> Markson S., (2021). What Really Happened in Wuhan, Sydney, Australia: Harper Collins Publishers. pgs. 369-372.

<sup>117</sup> Wan, Y., Shang, J., Sun, S., Tai, W., Chen, J., Geng, Q., He, L., Chen, Y., Su, J., Shi, Z-L., Zhou, Y., Du, L., Li, F. (2019). Molecular mechanism for antibody-dependent enhancement of coronavirus entry. *Journal of Virology*. 94(5) <https://doi.org/10.1128/jvi.02015-19>

<sup>118</sup> Zhou, Y., Gu, G., Sun H. S., He, L.H., Han G., Lang, X., Liu, J., Geng, S., Sheng, X. (February 24, 2020). Patent for Novel coronavirus COVID-19 vaccine, preparation method and application thereof. The Institute of Microbial Epidemiology, Academy of Military Medical Sciences. Application publication number CN 111333704 A.

<sup>119</sup> Sun S-H, Chen Q, Gu H-J, Yang G, Wang Y-X, X-Y H, Liu S-S, Zhang N-N, Li X-F, Xiong R, Guo Y, Deng Y-Q, Huang W-J, Liu Q, Liu Q-M, Shen Y-L, Zhou Y, Yang X, Zhao T-Y, Fan C-F, Zhou Y-S, Qin C-F, Wang Y-C. (2020). A mouse model of SARS-CoV-2 infection and pathogenesis. *Cell Host and Microbe*. 28, 124-133. <https://doi.org/10.1016/j.chom.2020.05.020>

<sup>120</sup> Gu, H., Chen, Q., Yang, G., He, L., Fan, H., Deng, Y. Q., Wang, Y., Teng, Y., Zhao, Z., Cui, Y., Li, Y., Li, X. F., Li, J., Zhang, N. N., Yang, X., Chen, S., Guo, Y., Zhao, G., Wang, X., Luo, D. Y., ... Zhou, Y. (2020). Adaptation of SARS-CoV-2 in BALB/c mice for testing vaccine efficacy. *Science (New York, N.Y.)*, 369(6511), 1603–1607. <https://doi.org/10.1126/science.abc4730>

<sup>121</sup> Sun, S., He, L., Zhao, Z. *et al.* (2021). Recombinant vaccine containing an RBD-Fc fusion induced protection against SARS-CoV-2 in nonhuman primates and mice. *Cell Mol Immunol* 18, 1070–1073. <https://doi.org/10.1038/s41423-021-00658-z>

<sup>122</sup> Gu, H., Chen, Q., Yang, G., He, L., Fan, H., Deng, Y. Q., Wang, Y., Teng, Y., Zhao, Z., Cui, Y., Li, Y., Li, X. F., Li, J., Zhang, N. N., Yang, X., Chen, S., Guo, Y., Zhao, G., Wang, X., Luo, D. Y., ... Zhou, Y. (2020). Adaptation of SARS-CoV-2 in BALB/c mice for testing vaccine efficacy. *Science (New York, N.Y.)*, 369(6511), 1603–1607. <https://doi.org/10.1126/science.abc4730>

<sup>123</sup> Sun, S., He, L., Zhao, Z. *et al.* (2021). Recombinant vaccine containing an RBD-Fc fusion induced protection against SARS-CoV-2 in nonhuman primates and mice. *Cell Mol Immunol* 18, 1070–1073. <https://doi.org/10.1038/s41423-021-00658-z>

<sup>124</sup> Wu, S., Zhong, G., Zhang, J., Shuai, L., Zhang, Z., Wen, Z., Wang, B., Zhao, Z., Song, X., Chen, Y., Liu, R., Fu, L., Zhang, J., Guo, Q., Wang, C., Yang, Y., Fang, T., Lv, P., Wang, J., Xu, J., ... Chen, W. (2020). A single dose of

an adenovirus-vectored vaccine provides protection against SARS-CoV-2 challenge. *Nature communications*, 11(1), 4081. <https://doi.org/10.1038/s41467-020-17972-1>

<sup>125</sup> Chen W., et al. A recombinant novel coronavirus vaccine using human replication deficient adenovirus as a vector. Application No. 202010193587.8.

[https://patents.google.com/patent/EP3950947A1/en?q=\(chen+A+recombinant+novel+coronavirus+vaccine+human+replication+deficient+adenovirus+vector.\)&oq=chen+A+recombinant+novel+coronavirus+vaccine+using+human+replication+deficient+adenovirus+as+a+vector.](https://patents.google.com/patent/EP3950947A1/en?q=(chen+A+recombinant+novel+coronavirus+vaccine+human+replication+deficient+adenovirus+vector.)&oq=chen+A+recombinant+novel+coronavirus+vaccine+using+human+replication+deficient+adenovirus+as+a+vector.)

<sup>126</sup> WHO-convened global study of origins of SARS-CoV-2: China Part. (2021).

<https://www.who.int/publications/i/item/who-convened-global-study-of-origins-of-sars-cov-2-china-part>

<sup>127</sup> The Office of the Spokesperson of the U.S. Department of State. (Jan. 15, 2021). Fact Sheet: Activity at the Wuhan Institute of Virology. U.S. Department of State.

<sup>128</sup> Ma J. (Mar. 13, 2020). Coronavirus: China's First Confirmed Covid-19 Case Traced Back to November 17.

South China Morning Post. <https://www.scmp.com/news/china/society/article/3074991/coronavirus-chinas-first-confirmed-covid-19-case-traced-back>

<sup>129</sup> Cobb N.L., Collier S., Attia E.F., Augusto O., West T.E., Wagenaar B.H. (2022). Global influenza surveillance systems to detect the spread of influenza-negative influenza-like illness during the COVID-19 pandemic: Time series outlier analyses from 2015–2020. *PLoS Med* 19(7): e1004035. <https://doi.org/10.1371/journal.pmed.1004035>

<sup>130</sup> US Government. (2009). A Tradecraft Primer: Structured Analytic Techniques for Improving Intelligence Analysis. <https://www.stat.berkeley.edu/~aldous/157/Papers/Tradecraft%20Primer-apr09.pdf>

<sup>131</sup> *Id.*

<sup>132</sup> Taylor MW. (2014). What Is a Virus? *Viruses and Man: A History of Interactions*. 22:23–40.

[https://doi.org/10.1007/978-3-319-07758-1\\_2](https://doi.org/10.1007/978-3-319-07758-1_2) PMID: PMC7122971.

<sup>133</sup> *Id.*

<sup>134</sup> *Id.*

<sup>135</sup> *Id.*

<sup>136</sup> *Id.*

<sup>137</sup> Siegel, R.D. (2018) Classification of Human Viruses. *Principles and Practice of Pediatric Infectious Diseases*. 2018:1044–1048.e1. <https://doi.org/10.1016/B978-0-323-40181-4.00201-2> Epub 2017 Jul 18. PMID: PMC7151951.

<sup>138</sup> Taylor, M.W. (2014). What Is a Virus? *Viruses and Man: A History of Interactions*. 22:23–40.

[https://doi.org/10.1007/978-3-319-07758-1\\_2](https://doi.org/10.1007/978-3-319-07758-1_2) PMID: PMC7122971 Siegel RD. (2018) Classification of Human Viruses. *Principles and Practice of Pediatric Infectious Diseases*. 2018:1044–1048.e1. <https://doi.org/10.1016/B978-0-323-40181-4.00201-2> Epub 2017 Jul 18. PMID: PMC7151951.

<sup>139</sup> Schoeman, D., & Fielding, B. C. (2019). Coronavirus envelope protein: current knowledge. *Virology journal*, 16(1), 69. <https://doi.org/10.1186/s12985-019-1182-0>

<sup>140</sup> Hu, B., Guo, H., Zhou, P., Shi, Z-L. (2020). Characteristics of SARS-CoV-2 and COVID-19. *Nature Reviews Microbiology*. 19(19):1-14. <https://doi.org/10.1038/s41579-020-00459-7>

<sup>141</sup> Alexandersen, S., Chamings, A., Bhatta, T. R. (2020). SARS-CoV-2 genomic and subgenomic RNAs in diagnostic samples are not an indicator of active replication. *Nature communications*, 11(1), 6059.

<https://doi.org/10.1038/s41467-020-19883-7>

<sup>142</sup> Lefkowitz, E.J., Dempsey, D.M., Hendrickson, R.C., Orton, R.J., Siddell, S.G., Smith, D.B. (2018). Virus taxonomy: the database of the International Committee on Taxonomy of Viruses (ICTV), *Nucleic Acids Research*, 46:D1 D708–D717. <https://doi.org/10.1016/B978-0-12-384684-6.00068-9>

<sup>143</sup> Frutos, R., Serra-Cobo, J., Pinault, L., Lopez Roig, M., & Devaux, C. A. (2021). Emergence of Bat-Related Betacoronaviruses: Hazard and Risks. *Frontiers in microbiology*, 12, 591535.

<https://doi.org/10.3389/fmicb.2021.591535>

<sup>144</sup> *Id.*

<sup>145</sup> *Id.*

<sup>146</sup> *Id.*

<sup>147</sup> *Id.*

<sup>148</sup> *Id.*

<sup>149</sup> Duffy, S. (2018). Why are RNA virus mutation rates so damn high?. *PLoS biology*, 16(8), e3000003.

<https://doi.org/10.1371/journal.pbio.3000003>

- <sup>150</sup> See <https://www.cdc.gov/flu/pandemic-resources/monitoring/viruses-concern.html>, “Novel influenza A viruses are of extra concern because of the potential impact they could have on public health if they gain the ability to spread easily from person to person, which might cause the next influenza pandemic.”
- <sup>151</sup> Robson, F., Khan, K. S., Le, T. K., Paris, C., Demirbag, S., Barfuss, P., Rocchi, P., & Ng, W. L. (2020). Coronavirus RNA Proofreading: Molecular Basis and Therapeutic Targeting. *Molecular cell*, *80*(6), 1136–1138. <https://doi.org/10.1016/j.molcel.2020.11.048>
- <sup>152</sup> Duffy S. (2018). Why are RNA virus mutation rates so damn high?. *PLoS biology*, *16*(8), e3000003. <https://doi.org/10.1371/journal.pbio.3000003>; Simon-Loriere, E., Holmes, E. Why do RNA viruses recombine?. *Nat Rev Microbiol* *9*, 617–626 (2011). <https://doi.org/10.1038/nrmicro2614>
- <sup>153</sup> *Id.*
- <sup>154</sup> Robson, F., Khan, K. S., Le, T. K., Paris, C., Demirbag, S., Barfuss, P., Rocchi, P., & Ng, W. L. (2020). Coronavirus RNA Proofreading: Molecular Basis and Therapeutic Targeting. *Molecular cell*, *80*(6), 1136–1138. <https://doi.org/10.1016/j.molcel.2020.11.048>
- <sup>155</sup> *Id.*
- <sup>156</sup> *Id.*
- <sup>157</sup> Duffy S. (2018). Why are RNA virus mutation rates so damn high?. *PLoS biology*, *16*(8), e3000003. <https://doi.org/10.1371/journal.pbio.3000003>; Simon-Loriere, E., Holmes, E. Why do RNA viruses recombine?. *Nat Rev Microbiol* *9*, 617–626 (2011). <https://doi.org/10.1038/nrmicro2614>
- <sup>158</sup> Mengist, H. M., Kombe, A. J., Mekonnen, D., Abebaw, A., Getachew, M., & Jin, T. (2021). Mutations of SARS-CoV-2 spike protein: Implications on immune evasion and vaccine-induced immunity. *Seminars in immunology*, *55*, 101533. <https://doi.org/10.1016/j.smim.2021.101533>
- <sup>159</sup> Yewdell, J. W. (2021). Antigenic drift: Understanding COVID-19. *Immunity*, *54*(12), 2681–2687. <https://doi.org/10.1016/j.immuni.2021.11.016>
- <sup>160</sup> Ho, S. (2014). The Molecular Clock and Estimating Species Divergence | Learn Science at Scitable. Nature.com. <https://www.nature.com/scitable/topicpage/the-molecular-clock-and-estimating-species-divergence-41971/>
- <sup>161</sup> Baillie, G. J., Galiano, M., Agapow, P. M., Myers, R., Chiam, R., Gall, A., Palser, A. L., Watson, S. J., Hedge, J., Underwood, A., Platt, S., McLean, E., Pebody, R. G., Rambaut, A., Green, J., Daniels, R., Pybus, O. G., Kellam, P., & Zambon, M. (2012). Evolutionary dynamics of local pandemic H1N1/2009 influenza virus lineages revealed by whole-genome analysis. *Journal of virology*, *86*(1), 11–18. <https://doi.org/10.1128/JVI.05347-11>
- <sup>162</sup> Smith, G. J., Vijaykrishna, D., Bahl, J., Lycett, S. J., Worobey, M., Pybus, O. G., Ma, S. K., Cheung, C. L., Raghvani, J., Bhatt, S., Peiris, J. S., Guan, Y., & Rambaut, A. (2009). Origins and evolutionary genomics of the 2009 swine-origin H1N1 influenza A epidemic. *Nature*, *459*(7250), 1122–1125. <https://doi.org/10.1038/nature08182>
- <sup>163</sup> Simon-Loriere, E., & Holmes, E. C. (2011). Why do RNA viruses recombine?. *Nature reviews. Microbiology*, *9*(8), 617–626. <https://doi.org/10.1038/nrmicro2614>
- <sup>164</sup> Pérez-Losada, M., Arenas, M., Galán, J. C., Palero, F., & González-Candelas, F. (2015). Recombination in viruses: mechanisms, methods of study, and evolutionary consequences. *Infection, genetics and evolution : journal of molecular epidemiology and evolutionary genetics in infectious diseases*, *30*, 296–307. <https://doi.org/10.1016/j.meegid.2014.12.022>
- <sup>165</sup> Fleischmann, W.R. (1996). Viral Genetics. Medical Microbiology. 4th edition PubMed. <https://www.ncbi.nlm.nih.gov/books/NBK8439/#:~:text=Viral%20recombination%20occurs%20when%20viruses>
- <sup>166</sup> Focosi, D., & Maggi, F. (2022). Recombination in Coronaviruses, with a Focus on SARS-CoV-2. *Viruses*, *14*(6), 1239. <https://doi.org/10.3390/v14061239>
- <sup>167</sup> Hu, B., Zeng, L. P., Yang, X. L., Ge, X. Y., Zhang, W., Li, B., Xie, J. Z., Shen, X. R., Zhang, Y. Z., Wang, N., Luo, D. S., Zheng, X. S., Wang, M. N., Daszak, P., Wang, L. F., Cui, J., & Shi, Z. L. (2017). Discovery of a rich gene pool of bat SARS-related coronaviruses provides new insights into the origin of SARS coronavirus. *PLoS pathogens*, *13*(11), e1006698. <https://doi.org/10.1371/journal.ppat.1006698>
- <sup>168</sup> Bobay, L. M., O'Donnell, A. C., & Ochman, H. (2020). Recombination events are concentrated in the spike protein region of Betacoronaviruses. *PLoS genetics*, *16*(12), e1009272. <https://doi.org/10.1371/journal.pgen.1009272>
- <sup>169</sup> *Id.*
- <sup>170</sup> Pollett, S., Conte, M. A., Sanborn, M., Jarman, R. G., Lidl, G. M., Modjarrad, K., & Maljkovic Berry, I. (2021). A comparative recombination analysis of human coronaviruses and implications for the SARS-CoV-2 pandemic. *Scientific reports*, *11*(1), 17365. <https://doi.org/10.1038/s41598-021-96626-8>
- <sup>171</sup> Dearlove, B., Lewitus, E., Bai, H., Li, Y., Reeves, D. B., Joyce, M. G., Scott, P. T., Amare, M. F., Vasan, S., Michael, N. L., Modjarrad, K., & Rolland, M. (2020). A SARS-CoV-2 vaccine candidate would likely match all

- currently circulating variants. *Proceedings of the National Academy of Sciences of the United States of America*, 117(38), 23652–23662. <https://doi.org/10.1073/pnas.2008281117>
- <sup>172</sup> Naqvi, A. A. T., Fatima, K., Mohammad, T., Fatima, U., Singh, I. K., Singh, A., Atif, S. M., Hariprasad, G., Hasan, G. M., & Hassan, M. I. (2020). Insights into SARS-CoV-2 genome, structure, evolution, pathogenesis and therapies: Structural genomics approach. *Biochimica et biophysica acta. Molecular basis of disease*, 1866(10), 165878. <https://doi.org/10.1016/j.bbadis.2020.165878>
- <sup>173</sup> *Id.*
- <sup>174</sup> Michel, C. J., Mayer, C., Poch, O., & Thompson, J. D. (2020). Characterization of accessory genes in coronavirus genomes. *Virology journal*, 17(1), 131. <https://doi.org/10.1186/s12985-020-01402-1>
- <sup>175</sup> Kopecky-Bromberg, S. A., Martínez-Sobrido, L., Frieman, M., Baric, R. A., & Palese, P. (2007). Severe acute respiratory syndrome coronavirus open reading frame (ORF) 3b, ORF 6, and nucleocapsid proteins function as interferon antagonists. *Journal of virology*, 81(2), 548–557. <https://doi.org/10.1128/JVI.01782-06>
- <sup>176</sup> Zamorano Cuervo, N., & Grandvaux, N. (2020). ACE2: Evidence of role as entry receptor for SARS-CoV-2 and implications in comorbidities. *eLife*, 9, e61390. <https://doi.org/10.7554/eLife.61390>
- <sup>177</sup> Sriram K, Insel P, Loomba R. (2020). What is the ACE2 receptor, how is it connected to coronavirus and why might it be key to treating COVID-19? The experts explain. The Conversation. Published May 14, 2020. <https://theconversation.com/what-is-the-ace2-receptor-how-is-it-connected-to-coronavirus-and-why-might-it-be-key-to-treating-covid-19-the-experts-explain-136928>
- <sup>178</sup> Turner AJ. ACE2 Cell Biology, Regulation, and Physiological Functions. The Protective Arm of the Renin Angiotensin System (RAS). Published online 2015:185-189. <https://doi.org/10.1016/b978-0-12-801364-9.00025-0>
- <sup>179</sup> *Id.*
- <sup>180</sup> Angiotensin Converting Enzyme 2 - an overview | ScienceDirect Topics. www.sciencedirect.com. <https://www.sciencedirect.com/topics/pharmacology-toxicology-and-pharmaceutical-science/angiotensin-converting-enzyme-2>
- <sup>181</sup> Turner AJ. ACE2 Cell Biology, Regulation, and Physiological Functions. The Protective Arm of the Renin Angiotensin System (RAS). Published online 2015:185-189. <https://doi.org/10.1016/b978-0-12-801364-9.00025-0>
- <sup>182</sup> Sriram K, Insel P, Loomba R. (2020). What is the ACE2 receptor, how is it connected to coronavirus and why might it be key to treating COVID-19? The experts explain. The Conversation. Published May 14, 2020. <https://theconversation.com/what-is-the-ace2-receptor-how-is-it-connected-to-coronavirus-and-why-might-it-be-key-to-treating-covid-19-the-experts-explain-136928>
- <sup>183</sup> Turner AJ. ACE2 Cell Biology, Regulation, and Physiological Functions. The Protective Arm of the Renin Angiotensin System (RAS). Published online 2015:185-189. <https://doi.org/10.1016/b978-0-12-801364-9.00025-0>
- <sup>184</sup> Hikmet, F., Méar, L., Edvinsson, Å., Micke, P., Uhlén, M., & Lindskog, C. (2020). The protein expression profile of ACE2 in human tissues. *Molecular systems biology*, 16(7), e9610. <https://doi.org/10.15252/msb.20209610>
- <sup>185</sup> Huang, Y., Yang, C., Xu, X. F., Xu, W., & Liu, S. W. (2020). Structural and functional properties of SARS-CoV-2 spike protein: potential antivirus drug development for COVID-19. *Acta pharmacologica Sinica*, 41(9), 1141–1149. <https://doi.org/10.1038/s41401-020-0485-4>
- <sup>186</sup> Huang, Y., Yang, C., Xu, X. F., Xu, W., & Liu, S. W. (2020). Structural and functional properties of SARS-CoV-2 spike protein: potential antivirus drug development for COVID-19. *Acta pharmacologica Sinica*, 41(9), 1141–1149. <https://doi.org/10.1038/s41401-020-0485-4>
- <sup>187</sup> *Id.*
- <sup>188</sup> Goldman B. (2020). How the new coronavirus penetrates, exploits and kills cells, and how an army of scientists aims to destroy it. *Stanford Magazine*. (2). [How the coronavirus destroys cells and how scientists attempt to disarm it | Stanford Medicine](https://www.stanfordmagazine.com/2020/04/how-the-coronavirus-destroys-cells-and-how-scientists-attempt-to-disarm-it/)
- <sup>189</sup> Mittal, A., Khattri, A., & Verma, V. (2022). Structural and antigenic variations in the spike protein of emerging SARS-CoV-2 variants. *PLoS pathogens*, 18(2), e1010260. <https://doi.org/10.1371/journal.ppat.1010260>
- <sup>190</sup> Pal M, Berhanu G, Desalegn C, Kandi V. (2020). Severe Acute Respiratory Syndrome Coronavirus-2 (SARS-CoV-2): An Update. *Cureus*. 12(3). <https://doi.org/10.7759/cureus.7423>
- <sup>191</sup> Roberts, A., Deming, D., Paddock, C. D., Cheng, A., Yount, B., Vogel, L., Herman, B. D., Sheahan, T., Heise, M., Genrich, G. L., Zaki, S. R., Baric, R., & Subbarao, K. (2007). A mouse-adapted SARS-coronavirus causes disease and mortality in BALB/c mice. *PLoS pathogens*, 3(1), e5. <https://doi.org/10.1371/journal.ppat.0030005>
- <sup>192</sup> Hulswit, R. J., de Haan, C. A., & Bosch, B. J. (2016). Coronavirus Spike Protein and Tropism Changes. *Advances in virus research*, 96, 29–57. <https://doi.org/10.1016/bs.aivir.2016.08.004>

- <sup>193</sup> Sun, Y., Cheng, J., Luo, Y., Yan, X. L., Wu, Z. X., He, L. L., Tan, Y. R., Zhou, Z. H., Li, Q. N., Zhou, L., Wu, R. T., Lan, T., & Ma, J. Y. (2019). Attenuation of a virulent swine acute diarrhea syndrome coronavirus strain via cell culture passage. *Virology*, 538, 61–70. <https://doi.org/10.1016/j.virol.2019.09.009>
- <sup>194</sup> MacLean OA, Lytras S, Weaver S, et al. (2021). Natural selection in the evolution of SARS-CoV-2 in bats created a generalist virus and highly capable human pathogen. *PLoS Biol.*19(3):e3001115. Published 2021 Mar 12. <https://doi.org/10.1371/journal.pbio.3001115>
- <sup>195</sup> Abdelrahman, Z., Li, M., & Wang, X. (2020). Comparative Review of SARS-CoV-2, SARS-CoV, MERS-CoV, and Influenza A Respiratory Viruses. *Frontiers in immunology*, 11, 552909. <https://doi.org/10.3389/fimmu.2020.552909>
- <sup>196</sup> MacLean OA, Lytras S, Weaver S, et al. (2021). Natural selection in the evolution of SARS-CoV-2 in bats created a generalist virus and highly capable human pathogen. Tully D, ed. *PLOS Biology*. 19(3):e3001115. <https://doi.org/10.1371/journal.pbio.3001115>
- <sup>197</sup> *Id.*
- <sup>198</sup> Howard A. (2021). SARS-CoV-2 jumped from bats to humans without much change. Interview with Professor Sergei Pond, the Institute for Genomics and Evolutionary Medicine, Temple University, Philadelphia. <https://www.eurekalert.org/news-releases/520840>
- <sup>199</sup> Boni MF, Lemey P, Jiang X, Lam TT, Perry BW, Castoe TA, Rambaut A, Robertson DL. (2020). Evolutionary origins of the SARS-CoV-2 sarbecovirus lineage responsible for the COVID-19 pandemic. *Nat Microbiol*. 5(11):1408-1417. <https://doi.org/10.1038/s41564-020-0771-4>
- <sup>200</sup> Tan, C. C. S., Lam, S. D., Richard, D., Owen, C. J., Berchtold, D., Orengo, C., Nair, M. S., Kuchipudi, S. V., Kapur, V., van Dorp, L., & Balloux, F. (2022). Transmission of SARS-CoV-2 from humans to animals and potential host adaptation. *Nature communications*, 13(1), 2988. <https://doi.org/10.1038/s41467-022-30698-6>
- <sup>201</sup> *Id.*
- <sup>202</sup> MacLean OA, Lytras S, Weaver S, et al. (2021). Natural selection in the evolution of SARS-CoV-2 in bats created a generalist virus and highly capable human pathogen. Tully D, ed. *PLOS Biology*.19(3):e3001115. <https://doi.org/10.1371/journal.pbio.3001115>
- <sup>203</sup> Peacock, T. P., Penrice-Randal, R., Hiscox, J. A., & Barclay, W. S. (2021). SARS-CoV-2 one year on: evidence for ongoing viral adaptation. *The Journal of general virology*, 102(4), 001584. <https://doi.org/10.1099/jgv.0.001584>
- <sup>204</sup> Tan, C. C. S., Lam, S. D., Richard, D., Owen, C. J., Berchtold, D., Orengo, C., Nair, M. S., Kuchipudi, S. V., Kapur, V., van Dorp, L., & Balloux, F. (2022). Transmission of SARS-CoV-2 from humans to animals and potential host adaptation. *Nature communications*, 13(1), 2988. <https://doi.org/10.1038/s41467-022-30698-6>
- <sup>205</sup> Peacock TP, Goldhill DH, Zhou J, et al. (2021). The furin cleavage site in the SARS-CoV-2 spike protein is required for transmission in ferrets. *Nature Microbiology*. Published online April 27, 2021:1-11. <https://doi.org/10.1038/s41564-021-00908-w>
- <sup>206</sup> Becker GL, Lu Y, Hards K, Strehlow B, Levesque C, Lindberg I, Sandvig K, Bakowsky U, Day R, Garten W, Steinmetzer T. (2012). Highly potent inhibitors of proprotein convertase furin as potential drugs for treatment of infectious diseases. *Journal of Biochemistry*. 287(26): 21992-22003. <https://doi.org/10.11074/jbc.M111.332643>
- <sup>207</sup> Chan, Y. A., & Zhan, S. H. (2022). The Emergence of the Spike Furin Cleavage Site in SARS-CoV-2. *Molecular biology and evolution*, 39(1), msab327. <https://doi.org/10.1093/molbev/msab327>
- <sup>208</sup> *Id.*
- <sup>209</sup> *Id.*
- <sup>210</sup> Johnson, B.A., Xie, X., Bailey, A.L. *et al.* (2021). Loss of furin cleavage site attenuates SARS-CoV-2 pathogenesis. *Nature* 591, 293–299. <https://doi.org/10.1038/s41586-021-03237-4>
- <sup>211</sup> *Id.*
- <sup>212</sup> Wu, Y., & Zhao, S. (2020). Furin cleavage sites naturally occur in coronaviruses. *Stem cell research*, 50, 102115. Advance online publication. <https://doi.org/10.1016/j.scr.2020.102115>
- <sup>213</sup> *Id.*
- <sup>214</sup> Wang, H., Pipes, L., & Nielsen, R. (2020). Synonymous mutations and the molecular evolution of SARS-CoV-2 origins. *Virus evolution*, 7(1), veaa098. <https://doi.org/10.1093/ve/veaa098>
- <sup>215</sup> Chan, Y. A., & Zhan, S. H. (2022). The Emergence of the Spike Furin Cleavage Site in SARS-CoV-2. *Molecular biology and evolution*, 39(1), msab327. <https://doi.org/10.1093/molbev/msab327>
- <sup>216</sup> Rabaan, A. A., Al-Ahmed, S. H., Haque, S., Sah, R., Tiwari, R., Malik, Y. S., Dhama, K., Yatoo, M. I., Bonilla-Aldana, D. K., & Rodriguez-Morales, A. J. (2020). SARS-CoV-2, SARS-CoV, and MERS-COV: A comparative overview. *Le infezioni in medicina*, 28(2), 174–184. [Vol 28 2 2020 7.pdf \(infezmed.it\)](https://doi.org/10.1007/s10086-020-02000-7)

- <sup>217</sup> Temmam, S., Vongphayloth, K., Baquero, E. *et al.* (2022). Bat coronaviruses related to SARS-CoV-2 and infectious for human cells. *Nature* 604, 330–336. <https://doi.org/10.1038/s41586-022-04532-4>
- <sup>218</sup> Zhou, H. *et al.* Identification of novel bat coronaviruses sheds light on the evolutionary origins of SARS-CoV-2 and related viruses. *Cell*. 2021.184, 4380–4391. <https://doi.org/10.1016/j.cell.2021.06.008>
- <sup>219</sup> Lytras, S. The Sarbecovirus origin of SARS-CoV-2's furin cleavage site. (2021) *Virological*. <https://virological.org/t/the-sarbecovirus-origin-of-sars-cov-2-s-furin-cleavage-site/536/6>
- <sup>220</sup> Lau, S. K. P., Luk, H. K. H., Wong, A. C. P., Li, K. S. M., Zhu, L., He, Z., Fung, J., Chan, T. T. Y., Fung, K. S. C., & Woo, P. C. Y. (2020). Possible Bat Origin of Severe Acute Respiratory Syndrome Coronavirus 2. *Emerging infectious diseases*, 26(7), 1542–1547. <https://doi.org/10.3201/eid2607.200092>
- <sup>221</sup> Peacock, T.P., Goldhill, D.H., Zhou, J., *et al.* (2021). The furin cleavage site in the SARS-CoV-2 spike protein is required for transmission in ferrets. *Nature Microbiology*. Published online April 27, 2021:1-11. <https://doi.org/10.1038/s41564-021-00908-w>
- <sup>222</sup> *Id.*
- <sup>223</sup> Borucki, M. K., Allen, J. E., Chen-Harris, H., Zemla, A., Vanier, G., Mabery, S., Torres, C., Hullinger, P., & Slezak, T. (2013). The role of viral population diversity in adaptation of bovine coronavirus to new host environments. *PloS one*, 8(1), e52752. <https://doi.org/10.1371/journal.pone.0052752>
- <sup>224</sup> Coutard, B., Valle, C., de Lamballerie, X., Canard, B., Seidah, N. G., & Decroly, E. (2020). The spike glycoprotein of the new coronavirus 2019-nCoV contains a furin-like cleavage site absent in CoV of the same clade. *Antiviral research*, 176, 104742. <https://doi.org/10.1016/j.antiviral.2020.104742>
- <sup>225</sup> *Id.*
- <sup>226</sup> Follis, K. E., York, J., & Nunberg, J. H. (2006). Furin cleavage of the SARS coronavirus spike glycoprotein enhances cell-cell fusion but does not affect virion entry. *Virology*, 350(2), 358–369. <https://doi.org/10.1016/j.virol.2006.02.003>
- <sup>227</sup> Watanabe, R., Matsuyama, S., Shirato, K., Maejima, M., Fukushi, S., Morikawa, S., & Taguchi, F. (2008). Entry from the cell surface of severe acute respiratory syndrome coronavirus with cleaved S protein as revealed by pseudotype virus bearing cleaved S protein. *Journal of virology*, 82(23), 11985–11991. <https://doi.org/10.1128/JVI.01412-08>
- <sup>228</sup> Li, X., Duan, G., Zhang, W., Shi, J., Chen, S., Gao, S., Ruan, J. (2020). A furin cleavage site was discovered in the S protein of the 2019 novel coronavirus. *Chinese Journal of Bioinformatics*. 18(2):103-108. <https://doi.org/10.2113/202002001>
- <sup>229</sup> Whittaker, G. R. (2021). SARS-CoV-2 spike and its adaptable furin cleavage site. *The Lancet. Microbe*, 2(10), e488–e489. [https://doi.org/10.1016/S2666-5247\(21\)00174-9](https://doi.org/10.1016/S2666-5247(21)00174-9)
- <sup>230</sup> Wang, P., Lau, S. Y., Deng, S., Chen, P., Mok, B. W., Zhang, A. J., Lee, A. C., Chan, K. H., Tam, R. C., Xu, H., Zhou, R., Song, W., Liu, L., To, K. K., Chan, J. F., Chen, Z., Yuen, K. Y., & Chen, H. (2021). Characterization of an attenuated SARS-CoV-2 variant with a deletion at the S1/S2 junction of the spike protein. *Nature communications*, 12(1), 2790. <https://doi.org/10.1038/s41467-021-23166-0>
- <sup>231</sup> Vu, M. N., Lokugamage, K. G., Plante, J. A., Scharton, D., Bailey, A. O., Sotcheff, S., Swetnam, D. M., Johnson, B. A., Schindewolf, C., Alvarado, R. E., Crocquet-Valdes, P. A., Debbink, K., Weaver, S. C., Walker, D. H., Russell, W. K., Routh, A. L., Plante, K. S., & Menachery, V. D. (2022). QTQTN motif upstream of the furin-cleavage site plays a key role in SARS-CoV-2 infection and pathogenesis. *Proceedings of the National Academy of Sciences of the United States of America*, 119(32), e2205690119. <https://doi.org/10.1073/pnas.2205690119>
- <sup>232</sup> Hoffmann, M., Kleine-Weber, H., Pohlmann, S. A. (2020). A multibasic cleavage site in the spike protein of SARS-CoV-2 is essential for infection of human lung cell. *Molecular Cell*. 78, 779-784 e775. <https://doi.org/10.1016/j.molcel.2020.04.022>
- <sup>233</sup> Vu, M. N., Lokugamage, K. G., Plante, J. A., Scharton, D., Bailey, A. O., Sotcheff, S., Swetnam, D. M., Johnson, B. A., Schindewolf, C., Alvarado, R. E., Crocquet-Valdes, P. A., Debbink, K., Weaver, S. C., Walker, D. H., Russell, W. K., Routh, A. L., Plante, K. S., & Menachery, V. D. (2022). QTQTN motif upstream of the furin-cleavage site plays a key role in SARS-CoV-2 infection and pathogenesis. *Proceedings of the National Academy of Sciences of the United States of America*, 119(32), e2205690119. <https://doi.org/10.1073/pnas.2205690119>
- <sup>234</sup> Johnson, B. A., Xie, X., Bailey, A. L., Kalveram, B., Lokugamage, K. G., Muruato, A., Zou, J., Zhang, X., Juelich, T., Smith, J. K., Zhang, L., Bopp, N., Schindewolf, C., Vu, M., Vanderheiden, A., Winkler, E. S., Swetnam, D., Plante, J. A., Aguilar, P., Plante, K. S., ... Menachery, V. D. (2021). Loss of furin cleavage site attenuates SARS-CoV-2 pathogenesis. *Nature*, 591(7849), 293–299. <https://doi.org/10.1038/s41586-021-03237-4>
- <sup>235</sup> *Id.*



- <sup>236</sup> Hu, B., Guo, H., Zhou, P., & Shi, Z. L. (2021). Characteristics of SARS-CoV-2 and COVID-19. *Nature reviews. Microbiology*, 19(3), 141–154. <https://doi.org/10.1038/s41579-020-00459-7>
- <sup>237</sup> Sigrist, C. J., Bridge, A., & Le Mercier, P. (2020). A potential role for integrins in host cell entry by SARS-CoV-2. *Antiviral research*, 177, 104759. <https://doi.org/10.1016/j.antiviral.2020.104759>
- <sup>238</sup> Kadry, Y.A., Calderwood, D.A. (2020). Structural and signaling functions of integrins. *BioChim Biophys Acta Biomember* <https://doi.org/10.1016/j.bbamem.2020.183206>
- <sup>239</sup> *Id.*
- <sup>240</sup> Hussein, H.A., Walker, L.R., Abdel-Raouf, U.M. (2015). Beyond RGD: virus interactions with integrins Arch Virol 160:2669-2681 <http://doi.org/10.1007/s00705-015-2579-8>
- <sup>241</sup> *Id.*
- <sup>242</sup> Sigrist, C. J., Bridge, A., & Le Mercier, P. (2020). A potential role for integrins in host cell entry by SARS-CoV-2. *Antiviral research*, 177, 104759. <https://doi.org/10.1016/j.antiviral.2020.104759>
- <sup>243</sup> Liu, J., Lu, F., Chen, Y., Plow, E., & Qin, J. (2022). Integrin mediates cell entry of the SARS-CoV-2 virus independent of cellular receptor ACE2. *The Journal of biological chemistry*, 298(3), 101710. <https://doi.org/10.1016/j.jbc.2022.101710>
- <sup>244</sup> Sigrist, C. J., Bridge, A., & Le Mercier, P. (2020). A potential role for integrins in host cell entry by SARS-CoV-2. *Antiviral research*, 177, 104759. <https://doi.org/10.1016/j.antiviral.2020.104759>
- <sup>245</sup> Liu, K., Pan, X., Li, L., Yu, F., Zheng, A., Du, P., Han, P., Meng, Y., Zhang, Y., Wu, L., Chen, Q., Song, C., Jia, Y., Niu, S., Lu, D., Qiao, C., Chen, Z., Ma, D., Ma, X., Tan, S., ... Wang, Q. (2021). Binding and molecular basis of the bat coronavirus RaTG13 virus to ACE2 in humans and other species. *Cell*, 184(13), 3438–3451.e10. <https://doi.org/10.1016/j.cell.2021.05.031>
- <sup>246</sup> Hu, B., Guo, H., Zhou, P., & Shi, Z. L. (2021). Characteristics of SARS-CoV-2 and COVID-19. *Nature reviews. Microbiology*, 19(3), 141–154. <https://doi.org/10.1038/s41579-020-00459-7>
- <sup>247</sup> Sigrist, C. J., Bridge, A., & Le Mercier, P. (2020). A potential role for integrins in host cell entry by SARS-CoV-2. *Antiviral research*, 177, 104759. <https://doi.org/10.1016/j.antiviral.2020.104759>
- <sup>248</sup> Yan, Shijia, Sun H., Bu, X., Wan ,G. (2020). New strategy for COVID-19: An evolutionary role for RGD Motif in SARS-CoV-2 and potential inhibitors for virus infection. *Frontiers in Pharmacology*. <https://doi.org/10.3389/fphar.2020.00912>
- <sup>249</sup> *Id.*
- <sup>250</sup> *Id.*
- <sup>251</sup> Ackermann, M., Verleden, S, Kuehnel, M., et al. 2020. Pulmonary vascular endothelialitis, thrombosis and angiogenesis in Covid-19 *N Engl J Med* 383:120-8 <http://doi:10.1056/NEJMoa2015432>
- <sup>252</sup> Makowski, L, Olson-Sidford, W, Weisel, JW, 2021. Biological and clinical consequences of integrin binding via a rogue motif in the SARS-CoV-2 spike protein 13: 146 <http://doi.org/10.3390/v13020146>
- <sup>253</sup> *Id.*
- <sup>254</sup> Nader D, Fletcher N, Curley GF, Kerrigan SW. 2021. SARS-CoV-2 uses major endothelial integrin  $\alpha v\beta 3$  to cause vascular dysregulation in-vitro during COVID-19. *PLOS One*. 16(6): e0253347 <https://doi.org/10.1371/journal.pone.0253347>
- <sup>255</sup> BurrNIH-00000485-490.
- <sup>256</sup> EcoHealth Alliance. Draft Defense Advanced Research Projects Agency proposal. Project DEFUSE: Defusing the threat of bat-borne coronaviruses. March 2018. HR001118S0017-PREEMPT-PA 001 <https://www.documentcloud.org/documents/21066966-defuse-proposal>
- <sup>257</sup> Frutos, R., Serra-Cobo, J., Pinault, L., Lopez Roig, M., & Devaux, C. A. (2021). Emergence of Bat-Related Betacoronaviruses: Hazard and Risks. *Frontiers in microbiology*, 12, 591535. <https://doi.org/10.3389/fmicb.2021.591535>
- <sup>258</sup> Nabi, G., Wang, Y., Lü, L., Jiang, C., Ahmad, S., Wu, Y., & Li, D. (2021). Bats and birds as viral reservoirs: A physiological and ecological perspective. *The Science of the total environment*, 754, 142372. <https://doi.org/10.1016/j.scitotenv.2020.142372>
- <sup>259</sup> Latinne, A., Hu, B., Olival, K. J., Zhu, G., Zhang, L., Li, H., Chmura, A. A., Field, H. E., Zambrana-Torrelío, C., Epstein, J. H., Li, B., Zhang, W., Wang, L. F., Shi, Z. L., & Daszak, P. (2020). Origin and cross-species transmission of bat coronaviruses in China. *Nature communications*, 11(1), 4235. <https://doi.org/10.1038/s41467-020-17687-3>
- <sup>260</sup> Olival, K. J., Hosseini, P. R., Zambrana-Torrelío, C., Ross, N., Bogich, T. L., & Daszak, P. (2017). Host and viral traits predict zoonotic spillover from mammals. *Nature*, 546(7660), 646–650. <https://doi.org/10.1038/nature22975>

- <sup>261</sup> Brierley, L., Vonhof, M. J., Olival, K. J., Daszak, P., & Jones, K. E. (2016). Quantifying Global Drivers of Zoonotic Bat Viruses: A Process-Based Perspective. *The American naturalist*, 187(2), E53–E64. <https://doi.org/10.1086/684391>
- <sup>262</sup> Li, W., Shi, Z., Yu, M., Ren, W., Smith, C., Epstein, J. H., Wang, H., Crameri, G., Hu, Z., Zhang, H., Zhang, J., McEachern, J., Field, H., Daszak, P., Eaton, B. T., Zhang, S., & Wang, L. F. (2005). Bats are natural reservoirs of SARS-like coronaviruses. *Science (New York, N.Y.)*, 310(5748), 676–679. <https://doi.org/10.1126/science.1118391>
- <sup>263</sup> Temmam, S., Vongphayloth, K., Baquero, E. *et al.* (2022). Bat coronaviruses related to SARS-CoV-2 and infectious for human cells. *Nature* 604, 330–336. <https://doi.org/10.1038/s41586-022-04532-4>
- <sup>264</sup> Zhu, Z., Meng, K., & Meng, G. (2020). Genomic recombination events may reveal the evolution of coronavirus and the origin of SARS-CoV-2. *Scientific reports*, 10(1), 21617. <https://doi.org/10.1038/s41598-020-78703-6>
- <sup>265</sup> Letko, M., Seifert, S. N., Olival, K. J., Plowright, R. K., & Munster, V. J. (2020). Bat-borne virus diversity, spillover and emergence. *Nature reviews. Microbiology*, 18(8), 461–471. <https://doi.org/10.1038/s41579-020-0394-z>
- <sup>266</sup> Yu P, Hu B, Shi ZL, Cui J. (2019). Geographical structure of bat SARS-related coronaviruses. *Infection, Genetics and Evolution*. 69:224-229. <https://doi.org/doi:10.1016/j.meegid.2019.02.001>
- <sup>267</sup> Mallapaty S. (2021). Closest known relatives of virus behind COVID-19 found in Laos. *Nature*. 597(7878):603-603. <https://doi.org/10.1038/d41586-021-02596-2>
- <sup>268</sup> Temmam, S., Vongphayloth, K., Baquero, E. *et al.* (2022). Bat coronaviruses related to SARS-CoV-2 and infectious for human cells. *Nature* 604, 330–336. <https://doi.org/10.1038/s41586-022-04532-4>
- <sup>269</sup> *Id.*
- <sup>270</sup> *Id.*
- <sup>271</sup> *Id.*
- <sup>272</sup> Temmam S., Montagutelli X., Hérate C. *et al.* (2022). SARS-CoV-2-Related Bat Virus in Human Relevant Models Sheds Light on the Proximal Origin of COVID-19. PREPRINT (Version 1) available at Research Square <https://doi.org/10.21203/rs.3.rs-1803095/v1>
- <sup>273</sup> Chan, Y. A., & Zhan, S. H. (2022). The Emergence of the Spike Furin Cleavage Site in SARS-CoV-2. *Molecular biology and evolution*, 39(1), msab327. <https://doi.org/10.1093/molbev/msab327>
- <sup>274</sup> Temmam S., Montagutelli X., Hérate C. *et al.* (2022). SARS-CoV-2-Related Bat Virus in Human Relevant Models Sheds Light on the Proximal Origin of COVID-19. PREPRINT (Version 1) available at Research Square <https://doi.org/10.21203/rs.3.rs-1803095/v1>
- <sup>275</sup> *Id.*
- <sup>276</sup> Liu K, Pan X, Li L, *et al.* (2021). Binding and molecular basis of the bat coronavirus RaTG-13 virus to ACE2 in humans and other species. *Cell*.184(13):3438-3451.e10. <https://doi.org/10.1016/j.cell.2021.05.031> According Shi, RaTG-13 was originally catalogued as sample ID4991 (Addendum: “A pneumonia outbreak associated with a new coronavirus of probable bat origin”)
- <sup>277</sup> Guo, H., Hu, B., Si, H. R., Zhu, Y., Zhang, W., Li, B., Li, A., Geng, R., Lin, H. F., Yang, X. L., Zhou, P., & Shi, Z. L. (2021). Identification of a novel lineage bat SARS-related coronaviruses that use bat ACE2 receptor. *Emerging microbes & infections*, 10(1), 1507–1514. <https://doi.org/10.1080/22221751.2021.1956373>
- <sup>278</sup> Holmes, E. C., Goldstein, S. A., Rasmussen, A. L., Robertson, D. L., Crits-Christoph, A., Wertheim, J. O., Anthony, S. J., Barclay, W. S., Boni, M. F., Doherty, P. C., Farrar, J., Geoghegan, J. L., Jiang, X., Leibowitz, J. L., Neil, S. J. D., Skern, T., Weiss, S. R., Worobey, M., Andersen, K. G., Garry, R. F., ... Rambaut, A. (2021). The origins of SARS-CoV-2: A critical review. *Cell*, 184(19), 4848–4856. <https://doi.org/10.1016/j.cell.2021.08.017>
- <sup>279</sup> “Viral recombination occurs when viruses of two different parent strains coinfect the same host cell and interact during replication to generate virus progeny that have some genes from both parents.” Fleischmann WR Jr. *Viral Genetics*. In: Baron S, editor. *Medical Microbiology*. 4<sup>th</sup> edition. Galveston (TX): University of Texas Medical Branch at Galveston; 1996. Chapter 43. Available from: <https://www.ncbi.nlm.nih.gov/books/NBK8439/>
- <sup>280</sup> Singh D, Yi SV. (2021). On the origin and evolution of SARS-CoV-2. *Experimental & Molecular Medicine*. 53. <https://doi.org/10.1038/s12276-021-00604-z> see also Sun J, Liu M, Yang N. Insight into the origin of SARS-CoV-2 through structural analysis of receptor recognition: a molecular simulation study. *RSC Advances*. 2021;11(15):8718-8729. <https://doi.org/10.1039/D1RA00127B>
- <sup>281</sup> Sun J, Liu M, Yang N. Insight into the origin of SARS-CoV-2 through structural analysis of receptor recognition: a molecular simulation study. *RSC Advances*. 2021;11(15):8718-8729. <https://doi.org/10.1039/D1RA00127B>
- <sup>282</sup> Lytras S, Xia W, Hughes J, Jiang X, Robertson DL. (2021). The animal origin of SARS-CoV-2. *Science*. 373(6558):968-970. <https://doi.org/10.1126/science.abh0117>
- <sup>283</sup> *Id.*

- <sup>284</sup> Zhou H, Ji J, Chen X, et al. (2021). Identification of novel bat coronaviruses sheds light on the evolutionary origins of SARS-CoV-2 and related viruses. *Cell*.184(17):4380-4391.e14. <https://doi.org/10.1016/j.cell.2021.06.008>
- <sup>285</sup> Chan YA, Zhan SH. (2021). The emergence of the spike furin cleavage site in SARS-CoV-2. Kumar S, ed. *Molecular Biology and Evolution*. Published online November 12, 2021. <https://doi.org/10.1093/molbev/msab327>
- <sup>286</sup> *Id.*
- <sup>287</sup> *Id.*
- <sup>288</sup> Allam Z. (2020). The First 50 days of COVID-19: A Detailed Chronological Timeline and Extensive Review of Literature Documenting the Pandemic. *Surveying the Covid-19 Pandemic and its Implications*, 1–7. <https://doi.org/10.1016/B978-0-12-824313-8.00001-2>.
- <sup>289</sup> World Health Organization. (2021). WHO-convened global study of origins of SARS-CoV-2: China Part. <https://www.who.int/publications/i/item/who-convened-global-study-of-origins-of-sars-cov-2-china-part>
- <sup>290</sup> Office of the Director of National Intelligence. (2021). Updated Assessment on COVID-19 Origins Key Takeaways. [Declassified-Assessment-on-COVID-19-Origins.pdf \(dni.gov\)](https://www.dni.gov/files/ODNI/documents/assessments/Declassified-Assessment-on-COVID-19-Origins.pdf)  
<https://www.dni.gov/files/ODNI/documents/assessments/Declassified-Assessment-on-COVID-19-Origins.pdf>
- <sup>291</sup> Pekar, J., Worobey, M., Moshiri, N., Scheffler, K., Wertheim J.O. (2021). Timing the SARS-CoV-2 index case in Hubei province. *Science* 372, no. 6540: 412-417 <https://doi.org/10.1126/science.abf8003>; see also Roberts, D. L., Rossman, J.S, Jarić, I. (2021). Dating first cases of COVID-19. *PLoS pathogens* 17, no. 6: e1009620.
- <sup>292</sup> Pekar J, Worobey M, Moshiri N, Scheffler K, Wertheim J O. (2021). Timing the SARS-Cov-2 index case in Hubei province. *Science*. 372(6540):412-417. <https://doi.org/10.1126/science.abf8003>
- <sup>293</sup> Lee E. (2021). Chasing the Virus Origin to Prepare for the Future a Systems Approach in Analyzing the Origin of SARS-CoV-2. [https://www.evalee-innovation.net/CenterORMedicine/Papers/2021\\_SARS\\_Origin\\_EvaLee.pdf](https://www.evalee-innovation.net/CenterORMedicine/Papers/2021_SARS_Origin_EvaLee.pdf)
- <sup>294</sup> *Id.*
- <sup>295</sup> World Health Organization. (2021). WHO-convened global study of origins of SARS-CoV-2: China Part. <https://www.who.int/publications/i/item/who-convened-global-study-of-origins-of-sars-cov-2-china-part>
- <sup>296</sup> *Id.*
- <sup>297</sup> World Health Organization Scientific Advisory Group for the Origins of Novel Pathogens (SAGO). (2022). Preliminary Report. [SAGO Preliminary Report \(who.int\)](https://www.who.int/publications/i/item/sago-preliminary-report)
- <sup>298</sup> Cobb NL, Collier S, Attia EF, Augusto O, West TE, Wagenaar BH (2022). Global influenza surveillance systems to detect the spread of influenza-negative influenza-like illness during the COVID-19 pandemic: Time series outlier analyses from 2015–2020. *PLoS Med* 19(7): e1004035. <https://doi.org/10.1371/journal.pmed.1004035>
- <sup>299</sup> The Novel Coronavirus Pneumonia Emergency Response Epidemiology Team. (Feb. 14, 2020). The epidemiological characteristics of an outbreak of 2019 novel coronavirus diseases (COVID-19) — China, 2020. China Center for Disease Control. <https://weekly.chinacdc.cn/en/article/id/e53946e2-c6c4-41e9-9a9b-fea8db1a8f51>.
- <sup>300</sup> United States Department of State. (2021). Fact Sheet: Activity at the Wuhan Institute of Virology. <https://2017-2021.state.gov/fact-sheet-activity-at-the-wuhan-institute-of-virology/index.html>
- <sup>301</sup> Dai, Y., & Wang, J. (2020). Identifying the outbreak signal of COVID-19 before the response of the traditional disease monitoring system. *PLoS neglected tropical diseases*, 14(10), e0008758. <https://doi.org/10.1371/journal.pntd.0008758>
- <sup>302</sup> Westergard R. (2020). Surviving the Outbreak: Reflections on ConGen Wuhan’s Evacuation and Life in Quarantine. *State Magazine*. <https://statemag.state.gov/2020/04/0420feat05/>.
- <sup>303</sup> Dai, Y., & Wang, J. (2020). Identifying the outbreak signal of COVID-19 before the response of the traditional disease monitoring system. *PLoS neglected tropical diseases*, 14(10), e0008758. <https://doi.org/10.1371/journal.pntd.0008758>
- <sup>304</sup> XinhuaNet. (Oct. 18, 2019). Military World Games Opens in Wuhan, Ushering in New Era. [http://www.xinhuanet.com/english/2019-10/18/c\\_138483351.htm#:~:text=18%20\(Xinhua\)%20%2D%2D%20Chinese%20President,couple%20of%20record%2Dbreaking%20endeavors.](http://www.xinhuanet.com/english/2019-10/18/c_138483351.htm#:~:text=18%20(Xinhua)%20%2D%2D%20Chinese%20President,couple%20of%20record%2Dbreaking%20endeavors.)
- <sup>305</sup> Rogin J. (June 23, 2021). Congress is Investigating Whether the 2019 Military World Games in Wuhan was a COVID-19 Superspreader Event. *Washington Post*. <https://www.washingtonpost.com/opinions/2021/06/23/congress-wuhan-military-games-2019-covid/>. See also Michael Houston. (May 17, 2020). More Athletes Claim They Contracted COVID-19 at Military World Games in Wuhan. *Inside the Games*. <https://www.insidethegames.biz/articles/1094347/world-military-games-illness-covid-19>; see also Kelly-Ann Mills. (May 7, 2020). French Army Returned from Wuhan Military Games in October with Mystery Illness. *The Mirror*. <https://www.mirror.co.uk/news/uk-news/french-army-returned-wuhan-military-21988912>; see also: Tristin Hopper. (Dec. 15, 2021). First Reading: Could a Prior Chinese International Sports

Event Have Seeded COVID-19 in Canada?. The National Post. <https://nationalpost.com/news/politics/first-reading-could-a-prior-chinese-international-sports-event-have-seeded-covid-19-in-canada>.

<sup>306</sup>Houston M. (May 17, 2020). More Athletes Claim They Contracted COVID-19 at Military World Games in Wuhan. Inside the Games. <https://www.insidethegames.biz/articles/1094347/world-military-games-illness-covid-19>

<sup>307</sup>Mills K-A.. (May 7, 2020). French Army Returned from Wuhan Military Games in October with Mystery Illness. The Mirror. <https://www.mirror.co.uk/news/uk-news/french-army-returned-wuhan-military-21988912>

<sup>308</sup> Squitieri T. (Jun. 30, 2020). Did the Military World Games Spread COVID-19?. The American Prospect. <https://prospect.org/coronavirus/did-the-military-world-games-spread-covid-19/>

<sup>309</sup> Konigsberg, I. R., Barnes, B., Campbell, M., Davidson, E., Zhen, Y., Pallisard, O., Boorgula, M. P., Cox, C., Nandy, D., Seal, S., Crooks, K., Sticca, E., Harrison, G. F., Hopkinson, A., Vest, A., Arnold, C. G., Kahn, M. G., Kao, D. P., Peterson, B. R., Wicks, S. J., ... Barnes, K. C. (2021). Host methylation predicts SARS-CoV-2 infection and clinical outcome. *Communications medicine*, 1(1), 42. <https://doi.org/10.1038/s43856-021-00042-y>

<sup>310</sup> Mao, W., Miller, C. M., Nair, V. D., Ge, Y., Amper, M. A. S., Cappuccio, A., George, M. C., Goforth, C. W., Guevara, K., Marjanovic, N., Nudelman, G., Pincas, H., Ramos, I., Sealson, R. S. G., Soares-Schanoski, A., Vangeti, S., Vasoya, M., Weir, D. L., Zaslavsky, E., Biobank Team, ... Chikina, M. (2023). A methylation clock model of mild SARS-CoV-2 infection provides insight into immune dysregulation. *Molecular systems biology*, e11361. Advance online publication. <https://doi.org/10.15252/msb.202211361>

<sup>311</sup> Radio Farda. (Mar. 22, 2020). Eleven Athletes in Iran Have Died of Coronavirus Infection. Radio Free Europe. <https://en.radiofarda.com/a/eleven-athletes-in-iran-have-died-of-coronavirus-infection/30502659.html>

<sup>312</sup> Ma VL, Nair MS. (Jun. 12, 2020). Coronavirus May Have Spread in China Last August, Preliminary Harvard Study Suggests. The Harvard Crimson. <https://www.thecrimson.com/article/2020/6/12/coronavirus-satellite-research/>

<sup>313</sup> Brownstein J.S., et al. (2020). Analysis of Hospital Traffic and Search Engine data in Wuhan China Indicates Early Disease Activity in the Fall of 2019. Harvard Library. <http://nrs.harvard.edu/urn-3:HUL.InstRepos:42669767/>

<sup>314</sup>Ma VL, Nair MS. (Jun. 12, 2020). Coronavirus May Have Spread in China Last August, Preliminary Harvard Study Suggests. The Harvard Crimson. <https://www.thecrimson.com/article/2020/6/12/coronavirus-satellite-research/>

<sup>315</sup> *Id.*

<sup>316</sup> Brownstein J.S., et al. (2020). Analysis of Hospital Traffic and Search Engine data in Wuhan China Indicates Early Disease Activity in the Fall of 2019. Harvard Library. <http://nrs.harvard.edu/urn-3:HUL.InstRepos:42669767/>

<sup>317</sup> Han, C., Duan, C., Zhang, S., Spiegel, B., Shi, H., Wang, W., Zhang, L., Lin, R., Liu, J., Ding, Z., & Hou, X. (2020). Digestive Symptoms in COVID-19 Patients With Mild Disease Severity: Clinical Presentation, Stool Viral RNA Testing, and Outcomes. *The American journal of gastroenterology*, 115(6), 916–923.

<https://doi.org/10.14309/ajg.0000000000000664>

<sup>318</sup> *Id.*

<sup>319</sup> Dai, Y., & Wang, J. (2020). Identifying the outbreak signal of COVID-19 before the response of the traditional disease monitoring system. *PLoS neglected tropical diseases*, 14(10), e0008758.

<https://doi.org/10.1371/journal.pntd.0008758>

<sup>320</sup> Qui J. (2022). Meet the Scientist at the Center of the Covid lab leak Controversy. MIT Technology Review <https://www.technologyreview.com/2022/02/09/1044985/shi-zhengli-covid-lab-leak-wuhan/>.

<sup>321</sup> *Id.*

<sup>322</sup> Markson S. (2021). What Really Happened in Wuhan: A Virus like No Other, Countless Infections, Millions of Deaths. Harpercollins Publishers Australia Pty Limited.

<sup>323</sup> The Office of the Spokesperson of the U.S. Department of State. (Jan. 15, 2021). Fact Sheet: Activity at the Wuhan Institute of Virology. U.S. Department of State.

<sup>324</sup> Sexton J. (Aug. 23, 2021). Josh Rogin: The Sick Researchers from the Wuhan Institute of Virology Lost their Sense of Smell. Hot Air; *see also* Honestly with Bari Weiss. (Aug. 23, 2021). You're Already Living in China's World Pt 1: The Lab Leak Lies. Apple Podcasts (Online).

<sup>325</sup> Office of the Director of National Intelligence. (2021). Updated Assessment on COVID-19 Origins Key Takeaways. <https://www.dni.gov/files/ODNI/documents/assessments/Declassified-Assessment-on-COVID-19-Origins.pdf>

<sup>326</sup>Birrell I. (May 29, 2021). Is 'Patient Su' Covid's Patient Zero?. The Daily Mail. <https://www.hindustantimes.com/world-news/is-wuhan-s-patient-su-covid-s-patient-zero-report-reveals-new-timeline-of-infection-101622360922716.html>.

<sup>327</sup> Experts judge the source of the new [coronavirus] December 12 last year may not be the earliest onset time.

专家研判新冠源头：去年 12 月 8 日或许不是最早发病时间. [www.guancha.cn](http://www.guancha.cn).

[https://www.guancha.cn/politics/2020\\_02\\_27\\_538822.shtml](https://www.guancha.cn/politics/2020_02_27_538822.shtml)

<sup>328</sup> Wang Z. (February. 27, 2020). Expert Assesses the Source of the Novel Coronavirus: December 8 of Last Year May Not be the Earliest Time of Onset. Health Times.

<https://docs.google.com/document/d/1DkO6pbwE93LolOmvv8rIS-yI52p7XgNTESoEA8aEhZA/edit>

<sup>329</sup> *Id.*

<sup>330</sup> Ma J. (Mar. 13, 2020). Coronavirus: China's First Confirmed Covid-19 Case Traced Back to November 17. South China Morning Post. <https://www.scmp.com/news/china/society/article/3074991/coronavirus-chinas-first-confirmed-covid-19-case-traced-back>.

<sup>331</sup> *Id.*

<sup>332</sup> *Id.*

<sup>333</sup> *Id.*

<sup>334</sup> Walsh NP. (Dec. 1, 2020). The Wuhan files. CNN. <https://edition.cnn.com/2020/11/30/asia/wuhan-china-covid-intl/index.html>.

<sup>335</sup> Reed C. (Mar. 4, 2020). What it's REALLY like to catch coronavirus: First British victim, 25, describes how 'worst disease he ever had' left him sweating, shivering, and struggling to breathe as his eyes burned and bones ached. The Daily Mail. <https://www.dailymail.co.uk/news/article-8075633/First-British-victim-25-describes-coronavirus.html>

<sup>336</sup> Dangerfield B. (Mar. 11, 2020). Briton Struck with Coronavirus in Wuhan Recalls: 'I Couldn't Get Enough Air'. Reuters. <https://www.reuters.com/article/us-health-coronavirus-wuhan-britain/briton-struck-with-coronavirus-in-wuhan-recalls-i-couldnt-get-enough-air-idUSKBN20Y22F>

<sup>337</sup> *Id.*

<sup>338</sup> *Id.*

<sup>339</sup> World Health Organization. (2022). Preliminary Report for the Scientific Advisory Group for the Origins of Novel Pathogens (SAGO). <https://www.who.int/publications/m/item/scientific-advisory-group-on-the-origins-of-novel-pathogens-report>

<sup>340</sup> Basavaraju, S. V., Patton, M. E., Grimm, K., Rasheed, M. A. U., Lester, S., Mills, L., Stumpf, M., Freeman, B., Tamin, A., Harcourt, J., Schiffer, J., Semenova, V., Li, H., Alston, B., Ategbale, M., Bolcen, S., Boulay, D., Browning, P., Cronin, L., David, E., ... Stramer, S. L. (2021). Serologic Testing of US Blood Donations to Identify Severe Acute Respiratory Syndrome Coronavirus 2 (SARS-CoV-2)-Reactive Antibodies: December 2019-January 2020. *Clinical infectious diseases : an official publication of the Infectious Diseases Society of America*, 72(12), e1004–e1009. <https://doi.org/10.1093/cid/ciaa1785>

<sup>341</sup> World Health Organization. (2022). Preliminary Report for the Scientific Advisory Group for the Origins of Novel Pathogens (SAGO). <https://www.who.int/publications/m/item/scientific-advisory-group-on-the-origins-of-novel-pathogens-report>

<sup>342</sup> World Health Organization. (2022). Preliminary Report for the Scientific Advisory Group for the Origins of Novel Pathogens (SAGO). <https://www.who.int/publications/m/item/scientific-advisory-group-on-the-origins-of-novel-pathogens-report>

<sup>343</sup> Fongaro, G., Stoco, P. H., Souza, D. S. M., Grisard, E. C., Magri, M. E., Rogovski, P., Schörner, M. A., Barazzetti, F. H., Christoff, A. P., de Oliveira, L. F. V., Bazzo, M. L., Wagner, G., Hernández, M., & Rodríguez-Lázaro, D. (2021). The presence of SARS-CoV-2 RNA in human sewage in Santa Catarina, Brazil, November 2019. *The Science of the total environment*, 778, 146198. <https://doi.org/10.1016/j.scitotenv.2021.146198>

<sup>344</sup> La Rosa, G., Mancini, P., Bonanno Ferraro, G., Veneri, C., Iaconelli, M., Bonadonna, L., Lucentini, L., & Suffredini, E. (2021). SARS-CoV-2 has been circulating in northern Italy since December 2019: Evidence from environmental monitoring. *The Science of the total environment*, 750, 141711. <https://doi.org/10.1016/j.scitotenv.2020.141711>

<sup>345</sup> Deslandes, A., Berti, V., Tandjaoui-Lambotte, Y., Alloui, C., Carbonnelle, E., Zahar, J. R., Briclher, S., & Cohen, Y. (2020). SARS-CoV-2 was already spreading in France in late December 2019. *International journal of antimicrobial agents*, 55(6), 106006. <https://doi.org/10.1016/j.ijantimicag.2020.106006>

<sup>346</sup> Markson S. (Sept. 2021). What Really Happened in Wuhan, Sydney, Australia: HarperCollins Publishers.

<sup>347</sup> Westergard RJ. (April 2020) "Surviving the Outbreak: Reflections on ConGen Wuhan's Evacuation and Life in Quarantine," STATE Magazine. <https://statemag.state.gov/2020/04/0420feat05/>

- <sup>348</sup> Peng, Z., Wang, R., Liu, L., & Wu, H. (2020). Exploring Urban Spatial Features of COVID-19 Transmission in Wuhan Based on Social Media Data. *ISPRS International Journal of Geo-Information*. 9(6), 402. <https://doi.org/10.3390/ijgi9060402>.
- <sup>349</sup> *Id.*
- <sup>350</sup> *Id.*
- <sup>351</sup> *Id.*
- <sup>352</sup> Li Y., Xue Y. (February 3, 2020) Enshi sealed 290 artificial breeding sites. Hubei Daily News. [http://news.cnhubei.com/content/2020-02/03/content\\_12677100.html](http://news.cnhubei.com/content/2020-02/03/content_12677100.html)
- <sup>353</sup> Standaert M., Dou E. (Oct. 11, 2021). In Search for Coronavirus Origins, Hubei caves and Wildlife Farms Draw New Scrutiny. *Washington Post*. [https://www.washingtonpost.com/world/asia\\_pacific/china-covid-bats-caves-hubei/2021/10/10/082eb8b6-1c32-11ec-bea8-308ea134594f\\_story.html](https://www.washingtonpost.com/world/asia_pacific/china-covid-bats-caves-hubei/2021/10/10/082eb8b6-1c32-11ec-bea8-308ea134594f_story.html)
- <sup>354</sup> *Id.*
- <sup>355</sup> *Id.*
- <sup>356</sup> Dept. of Wildlife Conservation. (Feb. 2, 2022). Hubei ‘Six Uniform’ to Control Wild Animals. State Forestry and Grassland Administration, Government of the People’s Republic of China. <http://www.forestry.gov.cn/bwwz/2784/20200513/085630366321198.html>.
- <sup>357</sup> Wu Z, McGoogan JM. (2020). Characteristics of and Important Lessons From the Coronavirus Disease 2019 (COVID-19) Outbreak in China: Summary of a Report of 72 314 Cases From the Chinese Center for Disease Control and Prevention. *JAMA*. 323(13):1239–1242. <https://doi.org/10.1001/jama.2020.2648>
- <sup>358</sup> Lucey, D.R. (Apr. 27, 2020). With Evidence Against the Origin of COVID-19 Being the Seafood Market in December, a call to Share and Discuss all data at the 73rd World Health Assembly in May. *Science Speaks*. Infectious Disease Society of America. [https://www.idsociety.org/science-speaks-blog/2020/with-evidence-against-the-origin-of-covid-19-being-the-seafood-market-in-december-a--call-to-share-and-discuss-all-data-at-the-73rd-world-health-assembly-in-may/#/+/0/publishedDate\\_na\\_dt/desc/](https://www.idsociety.org/science-speaks-blog/2020/with-evidence-against-the-origin-of-covid-19-being-the-seafood-market-in-december-a--call-to-share-and-discuss-all-data-at-the-73rd-world-health-assembly-in-may/#/+/0/publishedDate_na_dt/desc/).
- <sup>359</sup> WHO-China Report Annex D pg 116. <https://www.who.int/docs/default-source/coronaviruse/who-convened-global-study-of-origins-of-sars-cov-2-china-part-annexes.pdf>
- <sup>360</sup> The quoted text is “我市华南海鲜市场陆续出现不明原因肺炎病人。” See “Municipal Health Commission’s Urgent Notice on Reporting on the Critical Care Situation for Pneumonia of Unknown Etiology (市卫生健康委关于报送不明原因肺炎救治情况的紧急通知), Wuhan Municipal Health Commission reposted on Wikisource (维基文库) (Online), 30 December 2019.
- <sup>361</sup> The quoted text is “我市华南海鲜市场陆续出现不明原因肺炎病人。” See “Municipal Health Commission’s Urgent Notice on Reporting on the Critical Care Situation for Pneumonia of Unknown Etiology (市卫生健康委关于报送不明原因肺炎救治情况的紧急通知), Wuhan Municipal Health Commission reposted on Wikisource (维基文库) (Online), 30 December 2019.
- <sup>362</sup> *Id.* The quoted text is “未经授权任何单位, 个人不得擅自对外发布救治信息。”
- <sup>363</sup> The quoted text is “我市部分医疗机构陆续出现不明原因肺炎病人。” See “Urgent Notice on Doing a Good Job with Critical Care for Pneumonia of Unknown Etiology” (关于做好不明原因肺炎救治工作的紧急通知), Wuhan Municipal Health Commission reposted on Wikisource (维基文库) (Online), 30 December 2019.
- <sup>364</sup> See “Wuhan Municipal Health Commission Situational Report on a Pneumonia Epidemic Currently in our City” (武汉市卫健委关于当前我市肺炎疫情的情况通报), Wuhan Municipal Health Commission (Online), 31 December 2019.
- <sup>365</sup> *Id.*
- <sup>366</sup> Lawrence S. (May 13, 2020). COVID-19 and China: A Chronology of Events (December 2019-January 2020) Congressional Research Service. [https://www.everycrsreport.com/files/20200513\\_R46354\\_1fa921a2ce644b74c9de9dd2e96cc470ee1dc395.pdf](https://www.everycrsreport.com/files/20200513_R46354_1fa921a2ce644b74c9de9dd2e96cc470ee1dc395.pdf).
- <sup>367</sup> Li, Q. (2020). " Notes from the Field: An Outbreak of NCIP (2019-nCoV) Infection in China — Wuhan, Hubei Province, 2019–2020" *China CDC Weekly* 2, no. 5 (2020): 79. <https://weekly.chinacdc.cn/en/article/doi/10.46234/ccdcw2020.022>
- <sup>368</sup> Team, Epidemiology. (2020). "The epidemiological characteristics of an outbreak of 2019 novel coronavirus diseases (COVID-19)—China, 2020." *China CDC weekly* 2, no. 8: 113. <http://rs.yiigle.com/CN112338202002/1184694.htm>
- <sup>369</sup> Worobey M. (2021). Dissecting the early COVID-19 cases in Wuhan. *Science (New York, N.Y.)*, 374(6572), 1202–1204. <https://doi.org/10.1126/science.abm4454> .

- <sup>370</sup> J. Page, W. Fan, N. Khan, (2020). “How it all started: China’s early coronavirus missteps,” *Wall Street Journal* <https://www.wsj.com/articles/how-it-all-started-chinas-early-coronavirus-missteps-11583508932>
- <sup>371</sup> Du, W. (2020). “Experiencers tell the story: Whole story of the infection of medical staff in Wuhan Central Hospital,” *China Newsweek*.
- <sup>372</sup> Zhang, Y. Z., & Holmes, E. C. (2020). A Genomic Perspective on the Origin and Emergence of SARS-CoV-2. *Cell*, 181(2), 223–227. <https://doi.org/10.1016/j.cell.2020.03.035>
- <sup>373</sup> Team, Epidemiology. (2020). The Epidemiological Characteristics of an Outbreak of 2019 Novel Coronavirus Diseases (COVID-19) — China, 2020. *China CDC Weekly*. 2020;2(8):113-122. <https://doi.org/10.46234/ccdcw2020.032>
- <sup>374</sup> *Id.*
- <sup>375</sup> Rasmussen, S.A., Goodman, R. A. (2019). *The CDC Field Epidemiology Manual*. New York: Oxford University Press.
- <sup>376</sup> Team, Epidemiology. (2020). "The epidemiological characteristics of an outbreak of 2019 novel coronavirus diseases (COVID-19)—China, 2020." *China CDC weekly* 2, no. 8: 113. <http://rs.yiigle.com/CN112338202002/1184694.htm>
- <sup>377</sup> Pekar, J., Worobey, M., Moshiri, N., Scheffler, K., Wertheim, J.O. (2021). Timing the SARS-CoV-2 index case in Hubei province. *Science*. 372(6540):412-417. <https://doi.org/10.1126/science.abf8003> <https://www.science.org/doi/10.1126/science.abf8003>
- <sup>378</sup> Du, Z., Javan, E., Nugent, C., Cowling, B.J., Meyers, L.A. Using the COVID-19 to influenza ratio to estimate early pandemic spread in Wuhan, China and Seattle, US. *EClinicalMedicine*. 2020;26:100479. <https://doi.org/10.1016/j.eclinm.2020.100479>
- <sup>379</sup> Worobey, M., Levy, J.I., Serrano, L.M., et al. (2022). The Huanan Seafood Wholesale Market in Wuhan was the early epicenter of the COVID-19 pandemic. *Science*. <https://www.science.org/doi/10.1126/science.abp8715>
- <sup>380</sup> Rambaut, A., Holmes, E.C., O’Toole, Á., et al. (2020). A dynamic nomenclature proposal for SARS-CoV-2 lineages to assist genomic epidemiology. *Nature Microbiology*. 5(11), 1403–1407. <https://doi.org/10.1038/s41564-020-0770-5>
- <sup>381</sup> *Id.*
- <sup>382</sup> Cohen J. (2022). Do three new studies add up to proof of COVID-19’s origin in a Wuhan animal market? [www.science.org](https://www.science.org). <https://www.science.org/content/article/do-three-new-studies-add-proof-covid-19-s-origin-wuhan-animal-market>, discussing researchers “modeled what would have happened if there was an introduction of a single lineage and compared that with the viruses sequenced from Wuhan cases through 23 January 2020. By matching the sequence data from the actual epidemic, they found there was only a 3.6% chance that a single lineage mutated into a second one.”
- <sup>383</sup> Lau, S. K. P., Luk, H. K. H., Wong, A. C. P., Li, K. S. M., Zhu, L., He, Z., Fung, J., Chan, T. T. Y., Fung, K. S. C., & Woo, P. C. Y. (2020). Possible Bat Origin of Severe Acute Respiratory Syndrome Coronavirus 2. *Emerging infectious diseases*, 26(7), 1542–1547. <https://doi.org/10.3201/eid2607.200092>
- <sup>384</sup> U.S. Centers for Disease Control and Prevention. (2012). Introduction to Epidemiology: Epidemic Patterns: Common Source <https://www.cdc.gov/csels/dsepd/ss1978/Lesson1/Section11.html#ALT121>
- <sup>385</sup> Vlieg, W. L., Fanoy, E. B., van Asten, L., Liu, X., Yang, J., Pilot, E., Bijkerk, P., van der Hoek, W., Krafft, T., van der Sande, M. A., & Liu, Q. Y. (2017). Comparing national infectious disease surveillance systems: China and the Netherlands. *BMC public health*, 17(1), 415. <https://doi.org/10.1186/s12889-017-4319-3>
- <sup>386</sup> *Id.*
- <sup>387</sup> Xin I., Xiao W. (2020) The Yuan 730mln CDC reporting system that failed for 28 days. Caixin <https://docs.google.com/document/d/1KMtSoYS6Fv4L9zSz7acmPkiZ6eRnQjeMn0EexpK14t0/edit>
- <sup>388</sup> Han, C., Duan, C., Zhang, S., Spiegel, B., Shi, H., Wang, W., Zhang, L., Lin, R., Liu, J., Ding, Z., & Hou, X. (2020). Digestive Symptoms in COVID-19 Patients With Mild Disease Severity: Clinical Presentation, Stool Viral RNA Testing, and Outcomes. *The American journal of gastroenterology*, 115(6), 916–923. <https://doi.org/10.14309/ajg.0000000000000664>
- <sup>389</sup> Wong, S. H., Lui, R. N., & Sung, J. J. (2020). Covid-19 and the digestive system. *Journal of gastroenterology and hepatology*, 35(5), 744–748. <https://doi.org/10.1111/jgh.15047>
- <sup>390</sup> Han, C., Duan, C., Zhang, S., Spiegel, B., Shi, H., Wang, W., Zhang, L., Lin, R., Liu, J., Ding, Z., & Hou, X. (2020). Digestive Symptoms in COVID-19 Patients With Mild Disease Severity: Clinical Presentation, Stool Viral RNA Testing, and Outcomes. *The American journal of gastroenterology*, 115(6), 916–923. <https://doi.org/10.14309/ajg.0000000000000664>
- <sup>391</sup> *Id.*

- <sup>392</sup> Li, Q., Guan, X., Wu, P., Wang, X., Zhou, L., Tong, Y., Ren, R., Leung, K. S. M., Lau, E. H. Y., Wong, J. Y., Xing, X., Xiang, N., Wu, Y., Li, C., Chen, Q., Li, D., Liu, T., Zhao, J., Liu, M., Tu, W., ... Feng, Z. (2020). Early Transmission Dynamics in Wuhan, China, of Novel Coronavirus-Infected Pneumonia. *The New England journal of medicine*, 382(13), 1199–1207. <https://doi.org/10.1056/NEJMoa2001316>
- <sup>393</sup> Worobey, M., Levy, J. I., Malpica Serrano, L., Crits-Christoph, A., Pekar, J. E., Goldstein, S. A., Rasmussen, A. L., Kraemer, M. U. G., Newman, C., Koopmans, M. P. G., Suchard, M. A., Wertheim, J. O., Lemey, P., Robertson, D. L., Garry, R. F., Holmes, E. C., Rambaut, A., & Andersen, K. G. (2022). The Huanan Seafood Wholesale Market in Wuhan was the early epicenter of the COVID-19 pandemic. *Science (New York, N.Y.)*, 377(6609), 951–959. <https://doi.org/10.1126/science.abp8715>
- <sup>394</sup> *Id.*
- <sup>395</sup> Caixin. (2020). Why did the infectious disease network direct reporting system built with an investment of 730 million fail for 28 days? <https://docs.google.com/document/d/1KMtSoYS6Fv4L9zSz7acmPkiZ6eRnQjeMn0EexpK14t0/edit>
- <sup>396</sup> Huang Y. (2004). THE SARS EPIDEMIC AND ITS AFTERMATH IN CHINA: A POLITICAL PERSPECTIVE. In: Institute of Medicine (US) Forum on Microbial Threats; Knobler S, Mahmoud A, Lemon S, et al., editors. Learning from SARS: Preparing for the Next Disease Outbreak: Workshop Summary. Washington (DC): National Academies Press. <https://www.ncbi.nlm.nih.gov/books/NBK92479/>
- <sup>397</sup> Li, Q. (2020). "An outbreak of NCIP (2019-nCoV) infection in China—Wuhan, Hubei province, 2019–2020." *China CDC Weekly* 2, no. 5: 79. <https://weekly.chinacdc.cn/en/article/doi/10.46234/ccdcw2020.022>
- <sup>398</sup> Nishiura, H., Linton, N. M., & Akhmetzhanov, A. R. (2020). Initial Cluster of Novel Coronavirus (2019-nCoV) Infections in Wuhan, China Is Consistent with Substantial Human-to-Human Transmission. *Journal of clinical medicine*, 9(2), 488. <https://doi.org/10.3390/jcm9020488>
- <sup>399</sup> Tsang, T. K., Wu, P., Lin, Y., Lau, E. H. Y., Leung, G. M., & Cowling, B. J. (2020). Effect of changing case definitions for COVID-19 on the epidemic curve and transmission parameters in mainland China: a modelling study. *The Lancet. Public health*, 5(5), e289–e296. [https://doi.org/10.1016/S2468-2667\(20\)30089-X](https://doi.org/10.1016/S2468-2667(20)30089-X)
- <sup>400</sup> *Id.*
- <sup>401</sup> Kang D. (December 2020). China testing blunders stemmed from secret deals with firms. Associated Press News. [China testing blunders stemmed from secret deals with firms | AP News](https://www.foxnews.com/health/china-testing-blunders-stemmed-secret-deals-firms)
- <sup>402</sup> *Id.*
- <sup>403</sup> *Id.*
- <sup>404</sup> Chen, N., Zhou, M., Dong, X., Qu, J., Gong, F., Han, Y., Qiu, Y., Wang, J., Liu, Y., Wei, Y., Xia, J., Yu, T., Zhang, X., & Zhang, L. (2020). Epidemiological and clinical characteristics of 99 cases of 2019 novel coronavirus pneumonia in Wuhan, China: a descriptive study. *Lancet (London, England)*, 395(10223), 507–513. [https://doi.org/10.1016/S0140-6736\(20\)30211-7](https://doi.org/10.1016/S0140-6736(20)30211-7)
- <sup>405</sup> Tsang, T. K., Wu, P., Lin, Y., Lau, E. H. Y., Leung, G. M., & Cowling, B. J. (2020). Effect of changing case definitions for COVID-19 on the epidemic curve and transmission parameters in mainland China: a modelling study. *The Lancet. Public health*, 5(5), e289–e296. [https://doi.org/10.1016/S2468-2667\(20\)30089-X](https://doi.org/10.1016/S2468-2667(20)30089-X)
- <sup>406</sup> Xie, J. (March 28, 2020) "In China, Officials Exclude Asymptomatic COVID-19 Carriers From Data," *Voice of America* (Online). [https://www.voanews.com/a/science-health\\_coronavirus-outbreak\\_china-officials-exclude-asymptomatic-covid-19-carriers-data/6186569.html](https://www.voanews.com/a/science-health_coronavirus-outbreak_china-officials-exclude-asymptomatic-covid-19-carriers-data/6186569.html)
- <sup>407</sup> Tsang, T. K., Wu, P., Lin, Y., Lau, E. H. Y., Leung, G. M., & Cowling, B. J. (2020). Effect of changing case definitions for COVID-19 on the epidemic curve and transmission parameters in mainland China: a modelling study. *The Lancet. Public health*, 5(5), e289–e296. [https://doi.org/10.1016/S2468-2667\(20\)30089-X](https://doi.org/10.1016/S2468-2667(20)30089-X)
- <sup>408</sup> Xie J. (28 March 2020). "In China, Officials Exclude Asymptomatic COVID-19 Carriers From Data," *Voice of America* (Online). [https://www.voanews.com/a/science-health\\_coronavirus-outbreak\\_china-officials-exclude-asymptomatic-covid-19-carriers-data/6186569.html](https://www.voanews.com/a/science-health_coronavirus-outbreak_china-officials-exclude-asymptomatic-covid-19-carriers-data/6186569.html)
- <sup>409</sup> *Id.*
- <sup>410</sup> New York Times. (2020). *Most Coronavirus Cases Are Mild. That's Good and Bad News* <https://www.nytimes.com/2020/02/27/world/asia/coronavirus-treatment-recovery.html>
- <sup>411</sup> Tsang, T. K., Wu, P., Lin, Y., Lau, E. H. Y., Leung, G. M., & Cowling, B. J. (2020). Effect of changing case definitions for COVID-19 on the epidemic curve and transmission parameters in mainland China: a modelling study. *The Lancet. Public health*, 5(5), e289–e296. [https://doi.org/10.1016/S2468-2667\(20\)30089-X](https://doi.org/10.1016/S2468-2667(20)30089-X)
- <sup>412</sup> *Id.*



- <sup>413</sup>Xie J.(March 28, 2020). “In China, Officials Exclude Asymptomatic COVID-19 Carriers From Data,” *Voice of America* (Online). [https://www.voanews.com/a/science-health\\_coronavirus-outbreak\\_china-officials-exclude-asymptomatic-covid-19-carriers-data/6186569.html](https://www.voanews.com/a/science-health_coronavirus-outbreak_china-officials-exclude-asymptomatic-covid-19-carriers-data/6186569.html)
- <sup>414</sup> Gao Y., Peng Y., Yang R., Feng Y., Ma D., Murphy F., Han W., Shen T. (2020). “How Early Signs of the Coronavirus were Spotted, Spread and Throttled in China,” *Caixin Global* (Online), 28 February 2020. <https://www.straitstimes.com/asia/east-asia/how-early-signs-of-the-coronavirus-were-spotted-spread-and-throttled-in-china>
- <sup>415</sup> The Editorial Board of the Washington Post, “As the Pandemic Exploded, A Researcher Saw the Danger. China’s Leader Kept Silent,” *The Washington Post* (Online), 22 April 2022. <https://www.washingtonpost.com/opinions/interactive/2022/china-researcher-covid-19-coverup/>
- <sup>416</sup> Gao Yu, et. al. (28 February 2020.) The Associated Press also independently confirmed that Vision Medicals had sequenced the genome by December 27. See “China Delayed Releasing Coronavirus Info, Frustrating WHO,” *The Associated Press* (Online), 02 June 2020. <https://apnews.com/article/ united-nations-health-ap-top-news-virus-outbreak-public-health-3c061794970661042b18d5aeaaed9fae>
- <sup>417</sup> “WHO Statement regarding Cluster of Pneumonia Cases in Wuhan, China,” (09 January 2020). *World Health Organization* (Online).
- <sup>418</sup> Gao Y., Peng Y., Yang R., Feng Y., Ma D., Murphy F., Han W., Shen T. (2020). “How Early Signs of the Coronavirus were Spotted, Spread and Throttled in China,” *Caixin Global* (Online), 28 February 2020. <https://www.straitstimes.com/asia/east-asia/how-early-signs-of-the-coronavirus-were-spotted-spread-and-throttled-in-china>
- <sup>419</sup> *Id.*
- <sup>420</sup> *Id.*
- <sup>421</sup> *Id.*
- <sup>422</sup> *Id.*
- <sup>423</sup> *Id.*
- <sup>424</sup> *Id.*
- <sup>425</sup> Zhuang P. (28 February 2020). “Chinese Laboratory that First Shared Coronavirus Genome with World Ordered to Close for ‘Rectification’, Hindering its Covid-19 Research,” *South China Morning Post* (Online),. <https://www.scmp.com/news/china/society/article/3052966/chinese-laboratory-first-shared-coronavirus-genome-world-ordered>
- <sup>426</sup> Allam Z. (2020). “The First 50 days of COVID-19: A Detailed Chronological Timeline and Extensive Review of Literature Documenting the Pandemic” in *Surveying the Covid-19 Pandemic and its Implications*. Elsevier Public Health Emergency Collection (Online), p 4.. <https://doi.org/10.1016/B978-0-12-824313-8.00001-2>
- <sup>427</sup> Gao Y., et. al., 28 February 2020. The Associated Press also independently confirmed that Vision Medicals had sequenced the genome by December 27. See “China Delayed Releasing Coronavirus Info, Frustrating WHO,” *The Associated Press* (Online), 02 June 2020. <https://apnews.com/article/ united-nations-health-ap-top-news-virus-outbreak-public-health-3c061794970661042b18d5aeaaed9fae>
- <sup>428</sup> Wu, Z., & McGoogan, J. M. (2020). Characteristics of and Important Lessons From the Coronavirus Disease 2019 (COVID-19) Outbreak in China: Summary of a Report of 72 314 Cases From the Chinese Center for Disease Control and Prevention. *JAMA*, 323(13), 1239–1242. <https://jamanetwork.com/journals/jama/fullarticle/2762130>
- <sup>429</sup> Lucey D. (2020) With evidence against the origin of COVID-19 being the seafood market in December, a call to share and discuss all data at the 73rd World Health Assembly in May [https://www.idsociety.org/science-speaks-blog/2020/with-evidence-against-the-origin-of-covid-19-being-the-seafood-market-in-december-a-call-to-share-and-discuss-all-data-at-the-73rd-world-health-assembly-in-may/#/+/0/publishedDate\\_na\\_dt/asc/](https://www.idsociety.org/science-speaks-blog/2020/with-evidence-against-the-origin-of-covid-19-being-the-seafood-market-in-december-a-call-to-share-and-discuss-all-data-at-the-73rd-world-health-assembly-in-may/#/+/0/publishedDate_na_dt/asc/)
- <sup>430</sup> WHO-China Report Annex D pg 116 <https://www.who.int/docs/default-source/coronaviruse/who-convened-global-study-of-origins-of-sars-cov-2-china-part-annexes.pdf>
- <sup>431</sup> *Id.*
- <sup>432</sup> *Id.*
- <sup>433</sup> Lucey D.R. (24 August 2021). “Comments on Key Documents from the Early Weeks of SARS-CoV-2,” *Infectious Diseases Society of America* (Online). [https://www.idsociety.org/science-speaks-blog/2021/comments-on-key-documents-from-the-early-weeks-of-sars-cov-2/#/+/0/publishedDate\\_na\\_dt/asc/](https://www.idsociety.org/science-speaks-blog/2021/comments-on-key-documents-from-the-early-weeks-of-sars-cov-2/#/+/0/publishedDate_na_dt/asc/)
- <sup>434</sup> *Id.*

- <sup>435</sup> The original post has been removed from the website of the Wuhan Municipal People’s Government. For a secondary source, see Geraghty J. (23 March 2020). “The Comprehensive Timeline of China’s COVID-19 Lies,” *National Review* (Online). <https://www.nationalreview.com/the-morning-jolt/chinas-devastating-lies/>
- <sup>436</sup> Parry J. (2020). “China Coronavirus: Cases Surge as Official Admits Human-to-human Transmission,” *The BJM*, 2020, 368: m236, published online on 20 January 2020. <https://doi.org/10.1136/bmj.m236>
- <sup>437</sup> *Id.*
- <sup>438</sup> Wee S-L. (15 January 2020). “Japan and Thailand Confirm New Cases of Chinese Coronavirus,” *The New York Times* (Online). <https://www.nytimes.com/2020/01/15/world/asia/coronavirus-japan-china.html>
- <sup>439</sup> Parry J. (20 January 2020). “China Coronavirus: Cases Surge as Official Admits Human-to-human Transmission,” *The BJM*, 2020, 368: m236. <https://doi.org/10.1136/bmj.m236>
- <sup>440</sup> The original post has been removed from the website of the Wuhan Municipal People’s Government. For a secondary source, see Geraghty J. (23 March 2020). “The Comprehensive Timeline of China’s COVID-19 Lies,” *National Review* (Online). <https://www.nationalreview.com/the-morning-jolt/chinas-devastating-lies/>
- <sup>441</sup> *Xinhua News Agency*. (20 January 2020). “Novel Coronavirus Infectious Pneumonia Epidemic: Person-to-Person Transmission and Infection of Medical Personnel has Already Been Confirmed” (新型冠状病毒病毒感染肺炎疫情：已确认存在人传人和医务人员感染), (Online). [http://www.xinhuanet.com/english/2020-01/21/c\\_138722888.htm](http://www.xinhuanet.com/english/2020-01/21/c_138722888.htm)
- <sup>442</sup> Hernandez, J.C., Ramzy, A. (20 January 2020). “China Confirms New Coronavirus Spreads From Humans to Humans,” *New York Times* (Online). <https://www.nytimes.com/2020/01/20/world/asia/coronavirus-china-symptoms.html>
- <sup>443</sup> *Xinhua News Agency*. (20 January 2020). “Novel Coronavirus Infectious Pneumonia Epidemic: Person-to-Person Transmission and Infection of Medical Personnel has Already Been Confirmed” (新型冠状病毒病毒感染肺炎疫情：已确认存在人传人和医务人员感染), (Online). [http://www.xinhuanet.com/english/2020-01/21/c\\_138722888.htm](http://www.xinhuanet.com/english/2020-01/21/c_138722888.htm)
- Emphasis added. The quote is taken from this sentence: “目前疫情在武汉出现局部暴发的情况。”
- <sup>444</sup> *Id.* The quote is “我不相信它会像 17 年前非典造成的社会影响以及经济的损害。”
- <sup>445</sup> Ma J., Zhang P. (14 February 2020). “Chinese Medical Staff Paying ‘Too High a Price’ in Battle to Curb Coronavirus,” *South China Morning Post* (Online) <https://www.scmp.com/news/china/society/article/3050748/chinese-medical-staff-paying-too-high-price-battle-curb>
- <sup>446</sup> Lucey, D. R. (14 February 2020). “China Discloses 1,716 Healthcare Workers with Covid-19: Feb. 14, 2020,” *Infectious Diseases Society of America* (Online). [https://www.idsociety.org/science-speaks-blog/2020/china-discloses-1716-healthcare-workers-with-covid-19-feb.-14-2020/#/+0/publishedDate\\_na\\_dt/desc/](https://www.idsociety.org/science-speaks-blog/2020/china-discloses-1716-healthcare-workers-with-covid-19-feb.-14-2020/#/+0/publishedDate_na_dt/desc/)
- <sup>447</sup> *Id.*
- <sup>448</sup> *Wuhan Municipal Health Commission*. (31 December 2019). “Wuhan Municipal Health Commission Situational Report on a Pneumonia Epidemic Currently in our City” (武汉市卫健委关于当前我市肺炎疫情的情况通报), The exact statement at that time was “Up until now, the investigation has not yet uncovered obvious transmission from person-to-person nor infections of medical personnel.”
- <sup>449</sup> *The Associated Press* (Online). (15 April 2020). “China Didn’t Warn Public of Likely Pandemic for 6 Key Days.” <https://apnews.com/article/virus-outbreak-health-ap-top-news-international-news-china-clamps-down-68a9e1b91de4ffc166acd6012d82c2f9>
- <sup>450</sup> Phillips, N., Mallapaty, S., Cyranoski, D. “How Quickly Does the Wuhan Virus Spread?,” *Nature Magazine* (Online), 21 January 2020. <https://www.nature.com/articles/d41586-020-00146-w>
- <sup>451</sup> Ruan L., Knockel J., Crete-Nishihata M. (2020). Censored Contagion: How Information on the Coronavirus is Managed on Chinese Social Media. <https://citizenlab.ca/2020/03/censored-contagion-how-information-on-the-coronavirus-is-managed-on-chinese-social-media/>
- <sup>452</sup> Ruan L., Knockel J., Crete-Nishihata M. (2020). Censored Contagion: How Information on the Coronavirus is Managed on Chinese Social Media. <https://citizenlab.ca/2020/03/censored-contagion-how-information-on-the-coronavirus-is-managed-on-chinese-social-media/>
- <sup>453</sup> *Id.*
- <sup>454</sup> Gao Y., Peng Y., Yang R., Feng Y., Ma D., Murphy F., Han W., Shen T. (2020). “How Early Signs of the Coronavirus were Spotted, Spread and Throttled in China,” *Caixin Global* (Online), 28 February 2020. <https://www.straitstimes.com/asia/east-asia/how-early-signs-of-the-coronavirus-were-spotted-spread-and-throttled-in-china>

- <sup>455</sup> People's Daily (online), (02 January 2020). "Eight Pneumonia Epidemic Rumormongers in Wuhan Investigated and Dealt With" (武汉 8 名散布肺炎疫情谣言者被查处), People's Daily (Online). The quoted text is "8 名散布谣言者, 已被依法查处."
- <sup>456</sup> *Id.* The quoted text is "在网络上发布, 转发不实信息, 造成不良社会影响."
- <sup>457</sup> People's Daily (online), (02 January 2020). "Eight Pneumonia Epidemic Rumormongers in Wuhan Investigated and Dealt With" (武汉 8 名散布肺炎疫情谣言者被查处).
- <sup>458</sup> *China Central Television*, 02 January 2020, reposted on China Digital Times (Online). (29 January 2020). "CCTV: Eight Rumormongers Investigated and Dealt With" (CCTV: 8 名散布谣言者被查处).
- <sup>459</sup> Markson, S. (2021). *What Really Happened in Wuhan*, Sydney, Australia: HarperCollins Publishers, pg. 357-358.
- <sup>460</sup> Lin T. (林庭瑶), Ni H. (倪怀仁). (15 April 2020). "Exclusively Obtained Red-Letterhead Document: The Chinese Communist Party Concealed Wuhan Epidemic" (独家取得红头文件: 中共隐瞒武汉疫情), *The Storm Media (疯传媒)* (Online). Note a "red-letterhead document" in the PRC context refers to an official directive or policy document issued by a central government or communist party office. The relevant agency that produced the document is printed in red ink at the top. The Storm Media is based in Taiwan, not China. The Associated Press has also reviewed the official directive in question. See, "China Delayed Releasing Coronavirus Info, Frustrating WHO," *The Associated Press* (Online), 02 June 2020.
- <sup>461</sup> The Associated Press (Online). (02 June 2020). "China Delayed Releasing Coronavirus Info, Frustrating WHO." <https://apnews.com/article/united-nations-health-ap-top-news-virus-outbreak-public-health-3c061794970661042b18d5aeaaed9fae>
- <sup>462</sup> On file with Committee.
- <sup>463</sup> The Investigative Unit of the National Supervision Commission, "Notice Regarding the Investigation of the Situation Involving Dr. Li Wenliang and the Public Response," (关于群众反映的涉及李文亮医生有关情况调查的通报), *Xinhua* (Online), 19 March 2020.
- <sup>464</sup> McMullen J. "Covid-1 9: Five Days that Shaped the Outbreak," *BBC News* (Online), 26 January 2021 <https://www.bbc.com/news/world-55756452> ; .
- <sup>465</sup> Buckley, C. (6 February 2020). "Chinese Doctor, Silenced After Warning of Outbreak, Dies From Coronavirus," *New York Times* (Online). <https://www.nytimes.com/2020/02/06/world/asia/chinese-doctor-Li-Wenliang-coronavirus.html>
- <sup>466</sup> Nie, J. B., & Elliott, C. (2020). Humiliating Whistle-Blowers: Li Wenliang, the Response to Covid-19, and the Call for a Decent Society. *Journal of bioethical inquiry*, 17(4), 543–547. <https://doi.org/10.1007/s11673-020-09990-x>
- <sup>467</sup> Kuo, L. ( 01 March 2020). "'They're Chasing Me': the Journalist who wouldn't Stay Quiet on Covid-19," *the Guardian* (Online), <https://www.theguardian.com/world/2020/mar/01/li-zehua-journalist-wouldnt-stay-quiet-covid-19-coronavirus>
- <sup>468</sup> Tian, Y.L. (23 April 2020). "Chinese Citizen Journalist Resurfaces after Going Missing in Wuhan," *Reuters* (Online). <https://www.reuters.com/article/us-health-coronavirus-china-journalist/chinese-citizen-journalist-resurfaces-after-going-missing-in-wuhan-idUSKCN22515X>
- <sup>469</sup> Gan, N., Thomas, N. "Chen Qiushi Spoke Out about the Wuhan Virus. Now his Family and Friends Fear he's been Silenced," *CNN* (Online), 09 February 2020 <https://www.cnn.com/2020/02/09/asia/wuhan-citizen-journalist-intl-hnk/index.html> ; and Zhai K. "Chinese Citizen Journalist Who Documented Covid-19 in Wuhan Resurfaces After 600 Days," *Wall Street Journal* (Online), 01 October 202 <https://www.wsj.com/articles/chinese-citizen-journalist-who-documented-covid-19-in-wuhan-resurfaces-after-600-days-116330779561> .
- <sup>470</sup> "Coronavirus: Why have two reporters in Wuhan disappeared?," *BBC News* (Online) 14 February 2020 <https://www.bbc.com/news/world-asia-china-51486106> ; and "Concerns Grow For 'Disappeared' Wuhan Citizen Journalist," *Radio Free Asia* (Online), 09 March 2021 <https://www.rfa.org/english/news/china/wuhan-fangbin-03092021081706.html> .
- <sup>471</sup> Simmons, K., Jett, J., Perrette, A., Kuhr, E. (18 December 2021). "A Reporter Risked Her Life to Show the World Covid in Wuhan. Now She may not Survive Jail," *NBC News* (Online). <https://www.nbcnews.com/news/china/reporter-zhang-zhan-risked-life-show-world-covid-wuhan-now-may-not-survive-jail-rcna9212>
- <sup>472</sup> Chang, C. A., Ramzy, A. (08 October 2021). "Chinese Citizen Who Documented Wuhan Outbreak Falls Ill in Prison Hunger Strike," *New York Times* (Online). <https://www.nytimes.com/2021/08/25/world/asia/china-zhang-zhan-hunger-strike.html>

- <sup>473</sup> *Id.* The quoted text is “把疫情防控工作作为当前首要的政治任务... 举全办, 全系统之力切实做好疫情防控网上宣传引导工作...”
- <sup>474</sup> *Id.* The quoted text is “推动网上形成众志成城...” and “营造网上良好氛围.”
- <sup>475</sup> Ruan, L., Knockel, J., Crete-Nishihata, M. (2020). Censored Contagion: How Information on the Coronavirus is Managed on Chinese Social Media. <https://citizenlab.ca/2020/03/censored-contagion-how-information-on-the-coronavirus-is-managed-on-chinese-social-media/>
- <sup>476</sup> Ruan, L., Knockel, J., Crete-Nishihata, M. (2020). Censored Contagion: How Information on the Coronavirus is Managed on Chinese Social Media. <https://citizenlab.ca/2020/03/censored-contagion-how-information-on-the-coronavirus-is-managed-on-chinese-social-media/>
- <sup>477</sup> *Id.*
- <sup>478</sup> Eban, K., “The Lab Leak Theory: Inside the Fight to Uncover COVID-19’s Origins,” Vanity Fair (Online), 03 June 2021. <https://www.vanityfair.com/news/2021/06/the-lab-leak-theory-inside-the-fight-to-uncover-covid-19s-origins>
- <sup>479</sup> Zhou, P., Yang, X. L., Wang, X. G., Hu, B., Zhang, L., Zhang, W., Si, H. R., Zhu, Y., Li, B., Huang, C. L., Chen, H. D., Chen, J., Luo, Y., Guo, H., Jiang, R. D., Liu, M. Q., Chen, Y., Shen, X. R., Wang, X., Zheng, X. S., ... Shi, Z. L. (2020). A pneumonia outbreak associated with a new coronavirus of probable bat origin. *Nature*, 579(7798), 270–273. <https://doi.org/10.1038/s41586-020-2012-7>
- <sup>480</sup> U.S. Right to Know. (2020). Freedom of Information Act: Email From Matt Frieman to Vineet Men archery. Page 283. <https://usrtk.org/wp-content/uploads/2023/01/ED-20-01981-F-Dec-2022-Production-OPAQUE.pdf>
- <sup>481</sup> The Novel Coronavirus Pneumonia Emergency Response Epidemiology Team (2020). The Epidemiological Characteristics of an Outbreak of 2019 Novel Coronavirus Diseases (COVID-19) — China, 2020, China CDC Weekly, February 2020. <http://rs.yiigle.com/CN112338202002/1184694.htm>
- <sup>482</sup> Epidemiology Working Group for NCIP Epidemic Response, Chinese Center for Disease Control and Prevention (2020). *Zhonghua liu xing bing xue za zhi = Zhonghua liuxingbingxue zazhi*, 41(2), 145–151. <https://doi.org/10.3760/cma.j.issn.0254-6450.2020.02.003>
- <sup>483</sup> Oran, D. P., Topol, E. J. (2020). Prevalence of Asymptomatic SARS-CoV-2 Infection : A Narrative Review. *Annals of internal medicine*, 173(5), 362–367. <https://www.acpjournals.org/doi/10.7326/M20-3012>
- <sup>484</sup> Team, Epidemiology. (2020). "The epidemiological characteristics of an outbreak of 2019 novel coronavirus diseases (COVID-19)—China, 2020." *China CDC weekly* 2, no. 8: 113. <http://rs.yiigle.com/CN112338202002/1184694.htm>
- <sup>485</sup> Plowright, R. K., Parrish, C. R., McCallum, H., Hudson, P. J., Ko, A. I., Graham, A. L., & Lloyd-Smith, J. O. (2017). Pathways to zoonotic spillover. *Nature reviews. Microbiology*, 15(8), 502–510. <https://www.nature.com/articles/nrmicro.2017.45>
- <sup>486</sup> World Health Organization. Zoonoses. (2020). <https://www.who.int/news-room/fact-sheets/detail/zoonoses>
- <sup>487</sup> Jones, K. E., Patel, N. G., Levy, M. A., Storeygard, A., Balk, D., Gittleman, J. L., & Daszak, P. (2008). Global trends in emerging infectious diseases. *Nature*, 451(7181), 990–993. <https://doi.org/10.1038/nature06536>
- <sup>488</sup> *Id.*
- <sup>489</sup> Wade, N. (2010). Europe’s Plagues Came From China, Study Finds. *New York Times*. <https://www.nytimes.com/2010/11/01/health/01plague.html>
- <sup>490</sup> Shi, L., Yang, G., Zhang, Z., Xia, L., Liang, Y., Tan, H., He, J., Xu, J., Song, Z., Li, W., & Wang, P. (2018). Reemergence of human plague in Yunnan, China in 2016. *PloS one*, 13(6), e0198067. <https://journals.plos.org/plosone/article?id=10.1371/journal.pone.0198067>
- <sup>491</sup> Qin, Y., Zhao, M. J., Tan, Y. Y., Li, X. Q., Zheng, J. D., Peng, Z. B., & Feng, L. Z. (2018). *Zhonghua liu xing bing xue za zhi = Zhonghua liuxingbingxue zazhi*, 39(8), 1028–1031. <https://doi.org/10.3760/cma.j.issn.0254-6450.2018.08.003> <https://pubmed.ncbi.nlm.nih.gov/30180422/>
- <sup>492</sup> Hipgrave, D. (2011). Communicable disease control in China: From Mao to now. *Journal of global health*, 1(2), 224–238. <https://www.ncbi.nlm.nih.gov/pmc/articles/PMC3484775/>
- <sup>493</sup> Huang, Y. THE SARS EPIDEMIC AND ITS AFTERMATH IN CHINA: A POLITICAL PERSPECTIVE. In: Institute of Medicine (US) Forum on Microbial Threats; Knobler S, Mahmoud A, Lemon S, et al., editors. Learning from SARS: Preparing for the Next Disease Outbreak: Workshop Summary. Washington (DC): National Academies Press (US); 2004. Available from: <https://www.ncbi.nlm.nih.gov/books/NBK92479>
- <sup>494</sup> *Id.*

- <sup>495</sup> Centers for Disease Control and Prevention. (2017). SARS Basic Fact Sheet. <https://www.cdc.gov/sars/about/fs-sars.html>
- <sup>496</sup> Huang, Y. THE SARS EPIDEMIC AND ITS AFTERMATH IN CHINA: A POLITICAL PERSPECTIVE. In: Institute of Medicine (US) Forum on Microbial Threats; Knobler S, Mahmoud A, Lemon S, et al., editors. Learning from SARS: Preparing for the Next Disease Outbreak: Workshop Summary. Washington (DC): National Academies Press (US); 2004. <https://www.ncbi.nlm.nih.gov/books/NBK92486/>
- <sup>497</sup> *Id*
- <sup>498</sup> *Id*.
- <sup>499</sup> Freeman C.W.China's Capacity to Manage Infectious Diseases: Global Implications, CSIS pg. 10
- <sup>500</sup> Huang Y. THE SARS EPIDEMIC AND ITS AFTERMATH IN CHINA: A POLITICAL PERSPECTIVE. In: Institute of Medicine (US) Forum on Microbial Threats; Knobler S, Mahmoud A, Lemon S, et al., editors. Learning from SARS: Preparing for the Next Disease Outbreak: Workshop Summary. Washington (DC): National Academies Press (US); 2004. Available from: <https://www.ncbi.nlm.nih.gov/books/NBK92479/#>
- <sup>501</sup> *Id*.
- <sup>502</sup> Freeman, C.W., et al. (2009). China's Capacity to Manage Infectious Diseases: Global Implications, CSIS [China's Capacity to Manage Infectious Diseases \(csis.org\)](http://China's Capacity to Manage Infectious Diseases (csis.org))
- <sup>503</sup> *Id*.
- <sup>504</sup> Huang Y. THE SARS EPIDEMIC AND ITS AFTERMATH IN CHINA: A POLITICAL PERSPECTIVE. In: Institute of Medicine (US) Forum on Microbial Threats; Knobler S, Mahmoud A, Lemon S, et al., editors. Learning from SARS: Preparing for the Next Disease Outbreak: Workshop Summary. Washington (DC): National Academies Press (US); 2004. <https://www.ncbi.nlm.nih.gov/books/NBK92479/#>
- <sup>505</sup> *Id*.
- <sup>506</sup> Xu, R. H., He, J. F., Evans, M. R., Peng, G. W., Field, H. E., Yu, D. W., Lee, C. K., Luo, H. M., Lin, W. S., Lin, P., Li, L. H., Liang, W. J., Lin, J. Y., & Schnur, A. (2004). Epidemiologic clues to SARS origin in China. *Emerging infectious diseases*, 10(6), 1030–1037. <https://doi.org/10.3201/eid1006.030852> <https://www.ncbi.nlm.nih.gov/pmc/articles/PMC3323155/>
- <sup>507</sup> *Id*.
- <sup>508</sup> Freeman, C.W., et al. (2009). China's Capacity to Manage Infectious Diseases: Global Implications, CSIS [China's Capacity to Manage Infectious Diseases \(csis.org\)](http://China's Capacity to Manage Infectious Diseases (csis.org))
- <sup>509</sup> World Health Organization. (2006).SARS: How a Global Epidemic was Stopped, WHO pg 6 [https://apps.who.int/iris/bitstream/handle/10665/207501/9290612134\\_eng.pdf](https://apps.who.int/iris/bitstream/handle/10665/207501/9290612134_eng.pdf)
- <sup>510</sup> *Id*.
- <sup>511</sup> *Id*.
- <sup>512</sup> *Id*.
- <sup>513</sup> SARS: How a Global Epidemic was Stopped, WHO pg 7-8 [https://apps.who.int/iris/bitstream/handle/10665/207501/9290612134\\_eng.pdf](https://apps.who.int/iris/bitstream/handle/10665/207501/9290612134_eng.pdf)
- <sup>514</sup> *Id*.
- <sup>515</sup> *Id*.
- <sup>516</sup> *Id*.
- <sup>517</sup> *Id*.
- <sup>518</sup> *Id*.
- <sup>519</sup> Kahn J. (2007). China Bars U.S. Trip for Doctor Who Exposed SARS Cover-Up. New York Times (online). <https://www.nytimes.com/2007/07/13/world/asia/13doctor.html>
- <sup>520</sup> *Id*.
- <sup>521</sup> SARS: How a Global Epidemic was Stopped, WHO pg 29 [https://apps.who.int/iris/bitstream/handle/10665/207501/9290612134\\_eng.pdf](https://apps.who.int/iris/bitstream/handle/10665/207501/9290612134_eng.pdf)
- <sup>522</sup> Eckholm, E. *THE SARS EPIDEMIC: EPIDEMIC; China Admits Underreporting Its SARS Cases*. (2003). New York Times. <https://www.nytimes.com/2003/04/21/world/the-sars-epidemic-epidemic-china-admits-underreporting-its-sars-cases.html>
- <sup>523</sup> *Id*.
- <sup>524</sup> SARS: How a Global Epidemic was Stopped, WHO pg 79 [https://apps.who.int/iris/bitstream/handle/10665/207501/9290612134\\_eng.pdf](https://apps.who.int/iris/bitstream/handle/10665/207501/9290612134_eng.pdf)
- <sup>525</sup> Huang, Y. THE SARS EPIDEMIC AND ITS AFTERMATH IN CHINA: A POLITICAL PERSPECTIVE. In: Institute of Medicine (US) Forum on Microbial Threats; Knobler S, Mahmoud A, Lemon S, et al., editors. Learning

from SARS: Preparing for the Next Disease Outbreak: Workshop Summary. Washington (DC): National Academies Press (US); 2004. Available from: <https://www.ncbi.nlm.nih.gov/books/NBK92479>

<sup>526</sup> *Id.*

<sup>527</sup> *Id.*

<sup>528</sup> *Id.*

<sup>529</sup> *Id.*

<sup>530</sup> Merkely, S.C. (2022). Freedom of the Press and the 2002-2003 SARS Outbreak. Congressional-Executive Commission on China. <https://www.cecc.gov/freedom-of-the-press-and-the-2002-2003-sars-outbreak>

<sup>531</sup> *Id.*

<sup>532</sup> *Id.*

<sup>453</sup> *Id.*

<sup>534</sup> *Id.*

<sup>535</sup> FlorCruz, J. China Bars CNN SARS Report. (2003).

<https://www.cnn.com/2003/WORLD/asiapcf/east/05/14/sars.censor/>

<sup>536</sup> Merkely, S.C. (2022). Freedom of the Press and the 2002-2003 SARS Outbreak. Congressional-Executive Commission on China. <https://www.cecc.gov/freedom-of-the-press-and-the-2002-2003-sars-outbreak>

<sup>537</sup> *Id.*

<sup>538</sup> SARS: How a Global Epidemic was Stopped, WHO pg 35

[https://apps.who.int/iris/bitstream/handle/10665/207501/9290612134\\_eng.pdf](https://apps.who.int/iris/bitstream/handle/10665/207501/9290612134_eng.pdf)

[https://apps.who.int/iris/bitstream/handle/10665/207501/9290612134\\_eng.pdf](https://apps.who.int/iris/bitstream/handle/10665/207501/9290612134_eng.pdf)

<sup>539</sup> Wang, L. F., & Eaton, B. T. (2007). Bats, civets and the emergence of SARS. *Current topics in microbiology and immunology*, 315, 325–344. [https://doi.org/10.1007/978-3-540-70962-6\\_13](https://doi.org/10.1007/978-3-540-70962-6_13)

<sup>540</sup> Zhong, N. S., Zheng, B. J., Li, Y. M., Poon, Xie, Z. H., Chan, K. H., Li, P. H., Tan, S. Y., Chang, Q., Xie, J. P., Liu, X. Q., Xu, J., Li, D. X., Yuen, K. Y., Peiris, & Guan, Y. (2003). Epidemiology and cause of severe acute respiratory syndrome (SARS) in Guangdong, People's Republic of China, in February, 2003. *Lancet (London, England)*, 362(9393), 1353–1358. [https://doi.org/10.1016/s0140-6736\(03\)14630-2](https://doi.org/10.1016/s0140-6736(03)14630-2)

<sup>541</sup> Liang, G., Chen, Q., Xu, J., Liu, Y., Lim, W., Peiris, J. S., Anderson, L. J., Ruan, L., Li, H., Kan, B., Di, B., Cheng, P., Chan, K. H., Erdman, D. D., Gu, S., Yan, X., Liang, W., Zhou, D., Haynes, L., Duan, S., et al. (2004). SARS Diagnosis Working Group. Laboratory diagnosis of four recent sporadic cases of community-acquired SARS, Guangdong Province, China. *Emerging infectious diseases*, 10(10), 1774–1781.

<https://doi.org/10.3201/eid1010.040445>

<sup>542</sup> Centers for Disease Control and Prevention (CDC) (2003). Prevalence of IgG antibody to SARS-associated coronavirus in animal traders—Guangdong Province, China, 2003. *MMWR. Morbidity and mortality weekly report*, 52(41), 986–987. <https://pubmed.ncbi.nlm.nih.gov/14561956/>

<sup>543</sup> *Id.*

<sup>544</sup> Wang, L. F., & Eaton, B. T. (2007). Bats, civets and the emergence of SARS. *Current topics in microbiology and immunology*, 315, 325–344. [https://doi.org/10.1007/978-3-540-70962-6\\_13](https://doi.org/10.1007/978-3-540-70962-6_13)

<sup>545</sup> Guan, Y., Zheng, B. J., He, Y. Q., Liu, X. L., Zhuang, Z. X., Cheung, C. L., Luo, S. W., Li, P. H., Zhang, L. J., Guan, Y. J., Butt, K. M., Wong, K. L., Chan, K. W., Lim, W., Shortridge, K. F., Yuen, K. Y., Peiris, J. S., & Poon, L. L. (2003). Isolation and characterization of viruses related to the SARS coronavirus from animals in southern China. *Science (New York, N.Y.)*, 302(5643), 276–278. <https://doi.org/10.1126/science.1087139>

<https://pubmed.ncbi.nlm.nih.gov/12958366/>

<sup>546</sup> *Id.*

<sup>547</sup> Wang, L. F., & Eaton, B. T. (2007). Bats, civets and the emergence of SARS. *Current topics in microbiology and immunology*, 315, 325–344. [https://doi.org/10.1007/978-3-540-70962-6\\_13](https://doi.org/10.1007/978-3-540-70962-6_13)

<sup>548</sup> *Id.*

<sup>549</sup> Tu, C., Cramer, G., Kong, X., Chen, J., Sun, Y., Yu, M., Xiang, H., Xia, X., Liu, S., Ren, T., Yu, Y., Eaton, B. T., Xuan, H., & Wang, L. F. (2004). Antibodies to SARS coronavirus in civets. *Emerging infectious diseases*, 10(12), 2244–2248. <https://doi.org/10.3201/eid1012.040520>

<sup>550</sup> *Id.*

<sup>551</sup> Kan, B., Wang, M., Jing, H., Xu, H., Jiang, X., Yan, M., Liang, W., Zheng, H., Wan, K., Liu, Q., Cui, B., Xu, Y., Zhang, E., Wang, H., Ye, J., Li, G., Li, M., Cui, Z., Qi, X., Chen, K., ... Xu, J. (2005). Molecular evolution analysis and geographic investigation of severe acute respiratory syndrome coronavirus-like virus in palm civets at an animal market and on farms. *Journal of virology*, 79(18), 11892–11900. <https://doi.org/10.1128/JVI.79.18.11892-11900.2005>

<sup>552</sup> *Id.*

<sup>553</sup> SARS: How a Global Epidemic was Stopped, WHO, pg. 6

[https://apps.who.int/iris/bitstream/handle/10665/207501/9290612134\\_eng.pdf](https://apps.who.int/iris/bitstream/handle/10665/207501/9290612134_eng.pdf)

<sup>554</sup> Muth, D., Corman, V. M., Roth, H., Binger, T., Dijkman, R., Gottula, L. T., Gloza-Rausch, F., Balboni, A., Battilani, M., Rihtarič, D., Toplak, I., Ameneiros, R. S., Pfeifer, A., Thiel, V., Drexler, J. F., Müller, M. A., & Drosten, C. (2018). Attenuation of replication by a 29-nucleotide deletion in SARS-coronavirus acquired during the early stages of human-to-human transmission. *Scientific reports*, 8(1), 15177.

<https://www.nature.com/articles/s41598-018-33487-8>

<sup>555</sup> Wang, L-f, Eaton B.T. (2007). Bats, Civets and the Emergence of SARS.

[https://www.ncbi.nlm.nih.gov/pmc/articles/PMC7120088/pdf/978-3-540-70962-6\\_Chapter\\_13.pdf](https://www.ncbi.nlm.nih.gov/pmc/articles/PMC7120088/pdf/978-3-540-70962-6_Chapter_13.pdf)

<sup>556</sup> *Id.*

<sup>557</sup> Lau, S. K., Che, X. Y., Woo, P. C., Wong, B. H., Cheng, V. C., Woo, G. K., Hung, I. F., Poon, R. W., Chan, K. H., Peiris, J. S., & Yuen, K. Y. (2005). SARS coronavirus detection methods. *Emerging infectious diseases*, 11(7), 1108–1111. <https://doi.org/10.3201/eid1107.041045>

<sup>558</sup> Wang, L-f, Eaton B.T. (2007). Bats, Civets and the Emergence of SARS.

<https://www.ncbi.nlm.nih.gov/pmc/articles/PMC7120088/>

<sup>559</sup> Hu, B., Zeng, L. P., Yang, X. L., Ge, X. Y., Zhang, W., Li, B., Xie, J. Z., Shen, X. R., Zhang, Y. Z., Wang, N., Luo, D. S., Zheng, X. S., Wang, M. N., Daszak, P., Wang, L. F., Cui, J., & Shi, Z. L. (2017). Discovery of a rich gene pool of bat SARS-related coronaviruses provides new insights into the origin of SARS coronavirus. *PLoS pathogens*, 13(11), e1006698. <https://doi.org/10.1371/journal.ppat.1006698>

<sup>560</sup> Ge, X. Y., Li, J. L., Yang, X. L., Chmura, A. A., Zhu, G., Epstein, J. H., Mazet, J. K., Hu, B., Zhang, W., Peng, C., Zhang, Y. J., Luo, C. M., Tan, B., Wang, N., Zhu, Y., Cramer, G., Zhang, S. Y., Wang, L. F., Daszak, P., & Shi, Z. L. (2013). Isolation and characterization of a bat SARS-like coronavirus that uses the ACE2 receptor. *Nature*, 503(7477), 535–538. <https://doi.org/10.1038/nature12711>

<sup>561</sup> *Id.*

<sup>562</sup> *Id.*

<sup>563</sup> *Id.*

<sup>564</sup> *Id.*

<sup>565</sup> Yang, X. L., Hu, B., Wang, B., Wang, M. N., Zhang, Q., Zhang, W., Wu, L. J., Ge, X. Y., Zhang, Y. Z., Daszak, P., Wang, L. F., & Shi, Z. L. (2015). Isolation and Characterization of a Novel Bat Coronavirus Closely Related to the Direct Progenitor of Severe Acute Respiratory Syndrome Coronavirus. *Journal of virology*, 90(6), 3253–3256. <https://journals.asm.org/doi/full/10.1128/JVI.02582-15>

<sup>566</sup> Hu, B., Zeng, L. P., Yang, X. L., Ge, X. Y., Zhang, W., Li, B., Xie, J. Z., Shen, X. R., Zhang, Y. Z., Wang, N., Luo, D. S., Zheng, X. S., Wang, M. N., Daszak, P., Wang, L. F., Cui, J., & Shi, Z. L. (2017). Discovery of a rich gene pool of bat SARS-related coronaviruses provides new insights into the origin of SARS coronavirus. *PLoS pathogens*, 13(11), e1006698. <https://doi.org/10.1371/journal.ppat.1006698>

<sup>567</sup> Wang, L. F., Shi, Z., Zhang, S., Field, H., Daszak, P., & Eaton, B. T. (2006). Review of bats and SARS. *Emerging infectious diseases*, 12(12), 1834–1840. <https://doi.org/10.3201/eid1212.060401>

<sup>568</sup> Aguirre, A. A., Catherina, R., Frye, H., & Shelley, L. (2020). Illicit Wildlife Trade, Wet Markets, and COVID-19: Preventing Future Pandemics. *World medical & health policy*, 12(3), 256–265. <https://doi.org/10.1002/wmh3.348>

<sup>569</sup> Huang Y. (2004). THE SARS EPIDEMIC AND ITS AFTERMATH IN CHINA: A POLITICAL PERSPECTIVE. In: Institute of Medicine (US) Forum on Microbial Threats; Knobler S, Mahmoud A, Lemon S, et al., editors.

Learning from SARS: Preparing for the Next Disease Outbreak: Workshop Summary. Washington (DC): National Academies Press (US). Available from: <https://www.ncbi.nlm.nih.gov/books/NBK92479>

<sup>570</sup> Bouey, J. (2020). China's Health System Reform and Global Health Strategy in the Context of COVID-19. Santa Monica, CA: RAND Corporation. <https://www.rand.org/pubs/testimonies/CTA321-1.html>

<sup>571</sup> Sito P. (2020). What has China's public healthcare system learned from the twin coronavirus outbreaks of Sars and Covid-19? South China Morning Post. <https://www.scmp.com/business/china-business/article/3075095/what-has-chinas-public-healthcare-system-learned-twin>

<sup>572</sup> Bouey, J. (2020). China's Health System Reform and Global Health Strategy in the Context of COVID-19. Santa Monica, CA: RAND Corporation. <https://www.rand.org/pubs/testimonies/CTA321-1.html>

<sup>573</sup> Yang, W., Li, Z., Lan, Y., Ma, J., Jin, L., Lai, S., Liao, Y., Lv, W., Sun, Q., & Wang, J. (2017). China Infectious Diseases Automated-Alert and Response System (CIDARS). *Early Warning for Infectious Disease Outbreak*, 133–161. <https://doi.org/10.1016/B978-0-12-812343-0.00007-2>

- <sup>574</sup> Freemam C.W. (2020). China's Capacity to Manage Infectious Diseases: Global Implications, Center Strategic International Studies. [China's Capacity to Manage Infectious Diseases and Its Global Implications | CSIS Events](#)
- <sup>575</sup> Bouey, J. (2020). China's Health System Reform and Global Health Strategy in the Context of COVID-19. Santa Monica, CA: RAND Corporation. <https://www.rand.org/pubs/testimonies/CTA321-1.html>
- <sup>576</sup> Yang, W., Li, Z., Lan, Y., Ma, J., Jin, L., Lai, S., Liao, Y., Lv, W., Sun, Q., & Wang, J. (2017). China Infectious Diseases Automated-Alert and Response System (CIDARS). *Early Warning for Infectious Disease Outbreak*, 133–161. <https://doi.org/10.1016/B978-0-12-812343-0.00007-2>
- <sup>577</sup> *Id.*
- <sup>578</sup> *Id.*
- <sup>579</sup> *Id.*
- <sup>580</sup> *Id.*
- <sup>581</sup> *Id.*
- <sup>582</sup> Pang, X., Wang, X., Wang, Q., Gao, T., & Li, X. (2017). Infectious Disease Surveillance and Early Warning System During Beijing Olympic Games. *Early Warning for Infectious Disease Outbreak*, 163–180. <https://doi.org/10.1016/B978-0-12-812343-0.00008-4>
- <sup>583</sup> *Id.*
- <sup>584</sup> *Id.*
- <sup>585</sup> Freemam C.W. (2020). China's Capacity to Manage Infectious Diseases: Global Implications, Center Strategic International Studies. [China's Capacity to Manage Infectious Diseases and Its Global Implications | CSIS Events](#)
- <sup>586</sup> Bouey, J. (2020). China's Health System Reform and Global Health Strategy in the Context of COVID-19. Santa Monica, CA: RAND Corporation. <https://www.rand.org/pubs/testimonies/CTA321-1.html>
- <sup>587</sup> *Id.*
- <sup>588</sup> *Id.*
- <sup>589</sup> Xiang, N., Havers, F., Chen, T., Song, Y., Tu, W., Li, L., Cao, Y., Liu, B., Zhou, L., Meng, L., Hong, Z., Wang, R., Niu, Y., Yao, J., Liao, K., Jin, L., Zhang, Y., Li, Q., Widdowson, M. A., & Feng, Z. (2013). Use of national pneumonia surveillance to describe influenza A(H7N9) virus epidemiology, China, 2004-2013. *Emerging infectious diseases*, 19(11), 1784–1790. <https://doi.org/10.3201/eid1911.130865>
- <sup>590</sup> Qian, Y. H., Su, J., Shi, P., He, E. Q., Shao, J., Sun, N., Zu, R. Q., & Yu, R. B. (2011). Attempted early detection of influenza A (H1N1) pandemic with surveillance data of influenza-like illness and unexplained pneumonia. *Influenza and other respiratory viruses*, 5(6), e479–e486. <https://doi.org/10.1111/j.1750-2659.2011.00248.x>
- <sup>591</sup> Vlieg, W. L., Fanoy, E. B., van Asten, L., Liu, X., Yang, J., Pilot, E., Bijkerk, P., van der Hoek, W., Krafft, T., van der Sande, M. A., & Liu, Q. Y. (2017). Comparing national infectious disease surveillance systems: China and the Netherlands. *BMC public health*, 17(1), 415. <https://doi.org/10.1186/s12889-017-4319-3>
- <sup>592</sup> Yu W., Wu M., Garber A. (2006). Control of Infectious Disease: Challenges to China's Public Health System. Stanford University. [https://kingcenter.stanford.edu/sites/g/files/sbiybj16611/files/media/file/296wp\\_0.pdf](https://kingcenter.stanford.edu/sites/g/files/sbiybj16611/files/media/file/296wp_0.pdf)
- <sup>593</sup> Bouey, J. (2020). China's Health System Reform and Global Health Strategy in the Context of COVID-19. Santa Monica, CA: RAND Corporation, 2020. <https://www.rand.org/pubs/testimonies/CTA321-1.html>
- <sup>594</sup> *Id.*
- <sup>595</sup> Vlieg, W. L., Fanoy, E. B., van Asten, L., Liu, X., Yang, J., Pilot, E., Bijkerk, P., van der Hoek, W., Krafft, T., van der Sande, M. A., & Liu, Q. Y. (2017). Comparing national infectious disease surveillance systems: China and the Netherlands. *BMC public health*, 17(1), 415. <https://doi.org/10.1186/s12889-017-4319-3>
- <sup>596</sup> Bouey J. (2020). China's Health System Reform and Global Health Strategy in the Context of COVID-19. Santa Monica, CA: RAND Corporation, 2020. <https://www.rand.org/pubs/testimonies/CTA321-1.html>
- <sup>597</sup> *Id.*
- <sup>598</sup> *Id.*
- <sup>599</sup> *Id.*
- <sup>600</sup> Chen, H. H5N1 avian influenza in China. *Sci China Ser C. C* 52, 419–427 (2009). <https://doi.org/10.1007/s11427-009-0068-6>
- <sup>601</sup> *Id.*
- <sup>602</sup> *Id.*
- <sup>603</sup> Kedkovid, R., Sirisereewan, C., & Thanawongnuwech, R. (2020). Major swine viral diseases: an Asian perspective after the African swine fever introduction. *Porcine health management*, 6, 20. <https://doi.org/10.1186/s40813-020-00159-x>
- <sup>604</sup> *Id.*



- <sup>605</sup> Huang Y. (2020). The Biggest Animal Disease Outbreak in China. Council on Foreign Relations. <https://www.cfr.org/blog/biggest-animal-disease-outbreak-china>
- <sup>606</sup> Zhang X. (2019). Veterinary infectious diseases control in China. *The Lancet. Infectious diseases*, 19(4), 354–356. [https://doi.org/10.1016/S1473-3099\(19\)30117-3](https://doi.org/10.1016/S1473-3099(19)30117-3)
- <sup>607</sup> *Id.*
- <sup>608</sup> *Id.*
- <sup>609</sup> Wei X., Lin W., Hennessy D.A.(2013) Biosecurity and Disease Management in China’s Animal Agriculture Sector Iowa State University. <https://www.card.iastate.edu/products/publications/pdf/13wp542.pdf>
- <sup>610</sup> <https://www.card.iastate.edu/products/publications/pdf/13wp542.pdf>
- <sup>611</sup> *Id.*
- <sup>612</sup> *Id.*
- <sup>613</sup> The fight against bird flu. *Nature* 496, 397 (2013). <https://doi.org/10.1038/496397a>
- <sup>614</sup> Lin, Y. P., Yang, Z. F., Liang, Y., Li, Z. T., Bond, H. S., Chua, H., Luo, Y. S., Chen, Y., Chen, T. T., Guan, W. D., Lai, J. C. C., Siu, Y. L., Pan, S. H., Peiris, J. S. M., Cowling, B. J., & Mok, C. K. P. (2016). Population seroprevalence of antibody to influenza A(H7N9) virus, Guangzhou, China. *BMC infectious diseases*, 16(1), 632. <https://doi.org/10.1186/s12879-016-1983-3>
- <sup>615</sup> Kile, J. C., Ren, R., Liu, L., Greene, C. M., Roguski, K., Iuliano, A. D., Jang, Y., Jones, J., Thor, S., Song, Y., Zhou, S., Trock, S. C., Dugan, V., Wentworth, D. E., Levine, M. Z., Uyeki, T. M., Katz, J. M., Jernigan, D. B., Olsen, S. J., Fry, A. M., ... Davis, C. T. (2017). Update: Increase in Human Infections with Novel Asian Lineage Avian Influenza A(H7N9) Viruses During the Fifth Epidemic - China, October 1, 2016–August 7, 2017. *MMWR. Morbidity and mortality weekly report*, 66(35), 928–932. <https://doi.org/10.15585/mmwr.mm6635a2>
- <sup>616</sup> Guo-Lin Wang, Gregory C Gray, Ji-Ming Chen, Mai-Juan Ma, Will China’s H7N9 Control Strategy Continue to Be Effective?, *Open Forum Infectious Diseases*, Volume 6, Issue 6, June 2019, ofz258, <https://doi.org/10.1093/ofid/ofz258>
- <sup>617</sup> Centers for Disease Control and Prevention. Past Outbreaks. (2022). <https://www.cdc.gov/flu/avianflu/past-outbreaks.htm>
- <sup>618</sup> Zhou, P., Fan, H., Lan, T. *et al.* (2018). Fatal swine acute diarrhoea syndrome caused by an HKU2-related coronavirus of bat origin. *Nature* 556, 255–258. <https://doi.org/10.1038/s41586-018-0010-9>
- <sup>619</sup> *Id.*
- <sup>620</sup> *Id.*
- <sup>621</sup> *Id.*
- <sup>622</sup> Zhou, L., Li, Q. N., Su, J. N., Chen, G. H., Wu, Z. X., Luo, Y., Wu, R. T., Sun, Y., Lan, T., & Ma, J. Y. (2019). The re-emerging of SADS-CoV infection in pig herds in Southern China. *Transboundary and emerging diseases*, 66(5), 2180–2183. <https://doi.org/10.1111/tbed.13270>  
<https://www.ncbi.nlm.nih.gov/pmc/articles/PMC7168562/>
- <sup>623</sup> Zhou, P., Fan, H., Lan, T. *et al.* Fatal swine acute diarrhoea syndrome caused by an HKU2-related coronavirus of bat origin. *Nature* 556, 255–258 (2018). <https://doi.org/10.1038/s41586-018-0010-9>
- <sup>624</sup> Zhou, P., Fan, H., Lan, T. *et al.* Fatal swine acute diarrhoea syndrome caused by an HKU2-related coronavirus of bat origin. *Nature* 556, 255–258 (2018). <https://doi.org/10.1038/s41586-018-0010-9>
- <sup>625</sup> Zhang, X. A., Li, H., Jiang, F. C., Zhu, F., Zhang, Y. F., Chen, J. J., Tan, C. W., Anderson, D. E., Fan, H., Dong, L. Y., Li, C., Zhang, P. H., Li, Y., Ding, H., Fang, L. Q., Wang, L. F., & Liu, W. (2022). A Zoonotic Henipavirus in Febrile Patients in China. *The New England journal of medicine*, 387(5), 470–472. <https://doi.org/10.1056/NEJMc2202705> <https://www.nejm.org/doi/full/10.1056/NEJMc2202705>
- <sup>626</sup> *Id.*
- <sup>627</sup> *Id.*
- <sup>628</sup> *Id.*
- <sup>629</sup> *Id.* [https://www.nejm.org/doi/suppl/10.1056/NEJMc2202705/suppl\\_file/nejmc2202705\\_appendix.pdf](https://www.nejm.org/doi/suppl/10.1056/NEJMc2202705/suppl_file/nejmc2202705_appendix.pdf)
- <sup>630</sup> *Id.*
- <sup>631</sup> Gao G., Liu W., Liu P., Lei W., Jia Z., He X., Liu L-L. Shi W., Tan Y., Zou S., Zhao X., Wong, G., Wang J., Wang F., Wang G., Qin K., Gao R-b., Zhang J., Li M., Wu G. (Feb. 25, 2022). Surveillance of SARS-CoV-2 in the environment and animal samples of the Huanan Seafood Market. Research Square. <https://doi.org/10.21203/rs.3.rs-1370392/v1>.
- <sup>632</sup> Courtier-Orgogozo, Virginie & Francisco A. de Reibera. (Jul. 2, 2022). SARS-CoV-2 Infection at the Huanan Seafood Market. *Environmental Research*. 214, Part 1. <https://doi.org/10.1016/j.envres.2022.113702>.

- <sup>633</sup> Liu R, Li D, & Kaewunruen S. (2020). Role of Railway Transportation in the Spread of the Coronavirus: Evidence From Wuhan-Beijing Railway Corridor. *Front. Built Environ.* 6:590146. <https://doi.org/10.3389/fbuil.2020.590146>.
- <sup>634</sup> <http://tjj.wuhan.gov.cn/details.aspx?id=4615> (link now dead)
- <sup>635</sup> Pekar J, Worobey M, Moshiri N, Scheffler K, Wertheim JO., et al. (Mar. 18, 2021). Timing the SARS-CoV-2 index case in Hubei province. *Science.* 2021;372(6540):412-417. <https://doi.org/10.1126/science.abf8003>
- <sup>636</sup> Gao G., Liu W., Liu P., et al. Surveillance of SARS-CoV-2 in the environment and animal samples of the Huanan Seafood Market. PREPRINT (Version 1) available at Research Square <https://doi.org/10.21203/rs.3.rs-1370392/v1> pg. 4
- <sup>637</sup> Page, J., Khan, N. (May 12, 2020). On the Ground in Wuhan, Signs of China Stalling Probe of Coronavirus Origin. *Wall Street Journal.* [On the Ground in Wuhan, Signs of China Stalling Probe of Coronavirus Origins - WSJ](#)
- <sup>638</sup> *Id.*
- <sup>639</sup> World Health Organization. Report of the WHO-China Joint Mission on Coronavirus Disease 2019 (COVID-19) WHO-China Feb. 2020 Report, page 8. <https://www.who.int/docs/default-source/coronaviruse/who-china-joint-mission-on-covid-19-final-report.pdf>
- <sup>640</sup> Gao G., Liu W., Liu P., et al. Surveillance of SARS-CoV-2 in the environment and animal samples of the Huanan Seafood Market. PREPRINT (Version 1) available at Research Square <https://doi.org/10.21203/rs.3.rs-1370392/v1> pg. 4
- <sup>641</sup> Page, J., Khan, N. (May 12, 2020). On the Ground in Wuhan, Signs of China Stalling Probe of Coronavirus Origin. *Wall Street Journal.* [On the Ground in Wuhan, Signs of China Stalling Probe of Coronavirus Origins - WSJ](#)
- <sup>642</sup> World Health organization. (2021). WHO-convened Global Study of Origins of SARS-CoV-2: China Part Joint WHO-China Study 14 January-10 February 2021 Joint Report - ANNEXES WHO China Report, Annex E4 pg 174 <https://www.who.int/docs/default-source/coronaviruse/who-convened-global-study-of-origins-of-sars-cov-2-china-part-annexes.pdf>
- <sup>643</sup> *Id.*
- <sup>644</sup> Cohen J. (Jul. 17, 20121). With Call for ‘Raw Data’ and Lab Audits, WHO Chief Pressures China on Pandemic Origin Probe. *Science Insider.* <https://doi.org/10.1126/science.abl4763> .
- <sup>645</sup> World Health Organization. Report of the WHO-China Joint Mission on Coronavirus Disease 2019 (COVID-19) WHO-China Feb. 2020 Report, page 8. <https://www.who.int/docs/default-source/coronaviruse/who-china-joint-mission-on-covid-19-final-report.pdf>
- <sup>646</sup> *Id.* pg 181
- <sup>647</sup> Xu, H. F., Wang, M., Zhang, Z. B., Zou, X. Z., Gao, Y., Liu, X. N., Lu, E. J., Pan, B. Y., Wu, S. J., & Yu, S. Y. (Mar. 2004). *Zhonghua yu fang yi xue za zhi [Chinese journal of preventive medicine]*, 38(2), 81–83.
- <sup>648</sup> World Health organization. (2021). WHO-convened Global Study of Origins of SARS-CoV-2: China Part Joint WHO-China Study 14 January-10 February 2021 Joint Report - ANNEXES WHO China Report, Annex E4 pg 181 <https://www.who.int/docs/default-source/coronaviruse/who-convened-global-study-of-origins-of-sars-cov-2-china-part-annexes.pdf>
- <sup>649</sup> Gao G., Liu W., Liu P., et al. Surveillance of SARS-CoV-2 in the environment and animal samples of the Huanan Seafood Market. PREPRINT (Version 1) available at Research Square <https://doi.org/10.21203/rs.3.rs-1370392/v1> pg.4-5
- <sup>650</sup> *Id.*
- <sup>651</sup> *Id.*
- <sup>652</sup> *Id.*
- <sup>653</sup> Wang, X. (Jan. 26, 2020). Progress Continues in Coronavirus Trace. *China Daily.* <https://www.chinadaily.com.cn/a/202001/26/WS5e2d3124a3101282172734dd.html>; see also Lucey, D. R. (Mar. 15, 2020). Recent Data and Maps to Help Find the Origin of COVID-19. *Science Speaks.* Infectious Disease Society of America. [https://www.idsociety.org/science-speaks-blog/2020/recent-data-and-maps-to-help-find-the-origin-of-covid-19/#/+0/publishedDate\\_na\\_dt/asc/](https://www.idsociety.org/science-speaks-blog/2020/recent-data-and-maps-to-help-find-the-origin-of-covid-19/#/+0/publishedDate_na_dt/asc/).
- <sup>654</sup> Wang X. (Jan. 26, 2020). Progress Continues in Coronavirus Trace. *China Daily.* <https://www.chinadaily.com.cn/a/202001/26/WS5e2d3124a3101282172734dd.html>;
- <sup>655</sup> *Id.*
- <sup>656</sup> Worobey, M., Levy, J. I., Malpica Serrano, L., Crits-Christoph, A., Pekar, J. E., Goldstein, S. A., Rasmussen, A. L., Kraemer, M., Newman, C., Koopmans, M., Suchard, M. A., Wertheim, J. O., Lemey, P., Robertson, D. L., Garry, R. F., Holmes, E. C., Rambaut, A., & Andersen, K. G. (2022). The Huanan Seafood Wholesale Market in Wuhan

was the early epicenter of the COVID-19 pandemic. *Science (New York, N.Y.)*, 377(6609), 951–959.

<https://doi.org/10.1126/science.abp8715> pg. 3

<sup>657</sup> Gao G., Liu W., Liu P., et al. Surveillance of SARS-CoV-2 in the environment and animal samples of the Huanan Seafood Market. PREPRINT (Version 1) available at Research Square <https://doi.org/10.21203/rs.3.rs-1370392/v1> ] pg. 4-5

<sup>658</sup> *Id.*

<sup>659</sup> Worobey, M., Levy, J. I., Malpica Serrano, L., Crits-Christoph, A., Pekar, J. E., Goldstein, S. A., Rasmussen, A. L., Kraemer, M., Newman, C., Koopmans, M., Suchard, M. A., Wertheim, J. O., Lemey, P., Robertson, D. L., Garry, R. F., Holmes, E. C., Rambaut, A., & Andersen, K. G. (2022). The Huanan Seafood Wholesale Market in Wuhan was the early epicenter of the COVID-19 pandemic. *Science (New York, N.Y.)*, 377(6609), 951–959.

<https://doi.org/10.1126/science.abp8715>pg. 5

<sup>660</sup> Gao G., Liu W., Liu P., et al. Surveillance of SARS-CoV-2 in the environment and animal samples of the Huanan Seafood Market. PREPRINT (Version 1) available at Research Square <https://doi.org/10.21203/rs.3.rs-1370392/v1>

<sup>661</sup> *Id.*

<sup>662</sup> *Id.*

<sup>663</sup> World Health Organization. Report of the WHO-China Joint Mission on Coronavirus Disease 2019 (COVID-19) WHO-China Feb. 2020 Report, page 98. <https://www.who.int/docs/default-source/coronaviruse/who-china-joint-mission-on-covid-19-final-report.pdf>

<sup>664</sup> World Health organization. (2021). WHO-convened Global Study of Origins of SARS-CoV-2: China Part Joint WHO-China Study 14 January-10 February 2021 Joint Report - ANNEXES WHO China Report, Annex D4 pg 122 <https://www.who.int/docs/default-source/coronaviruse/who-convened-global-study-of-origins-of-sars-cov-2-china-part-annexes.pdf>

<sup>665</sup> World Health Organization. Report of the WHO-China Joint Mission on Coronavirus Disease 2019 (COVID-19) WHO-China Feb. 2020 Report, page 98. <https://www.who.int/docs/default-source/coronaviruse/who-china-joint-mission-on-covid-19-final-report.pdf>

<sup>666</sup> United States Centers for Disease Control and Prevention. (Jul. 5, 2022). Animals and COVID-19. United States Department of Health and Human Services. <https://www.cdc.gov/coronavirus/2019-ncov/daily-life-coping/animals.html>.

<sup>667</sup> World Health Organization. Report of the WHO-China Joint Mission on Coronavirus Disease 2019 (COVID-19) WHO-China Feb. 2020 Report, page 98. <https://www.who.int/docs/default-source/coronaviruse/who-china-joint-mission-on-covid-19-final-report.pdf>

<sup>668</sup> *Id.* pg 97.

<sup>669</sup> *Id.* pg 99.

<sup>670</sup> *Id.*

<sup>671</sup> *Id.* pg 98

<sup>672</sup> *Id.*

<sup>673</sup> World Health organization. (2021). WHO-convened Global Study of Origins of SARS-CoV-2: China Part Joint WHO-China Study 14 January-10 February 2021 Joint Report - ANNEXES WHO China Report, Annex D4 pg 122 <https://www.who.int/docs/default-source/coronaviruse/who-convened-global-study-of-origins-of-sars-cov-2-china-part-annexes.pdf>

<sup>674</sup> *Id.*

<sup>675</sup> Xiao, X., Newman, C., Buesching, C.D. *et al.* (Jun. 7, 2021). Animal Sales from Wuhan Wet Markets Immediately Prior to the COVID-19 Pandemic. *Scientific Reports*. 11: 11898. <https://doi.org/10.1038/s41598-021-91470-2>

<sup>676</sup> *Id.*

<sup>677</sup> *Id.*

<sup>678</sup> Worobey, M., Levy, J. I., Malpica Serrano, L., Crits-Christoph, A., Pekar, J. E., Goldstein, S. A., Rasmussen, A. L., Kraemer, M., Newman, C., Koopmans, M., Suchard, M. A., Wertheim, J. O., Lemey, P., Robertson, D. L., Garry, R. F., Holmes, E. C., Rambaut, A., & Andersen, K. G. (2022). The Huanan Seafood Wholesale Market in Wuhan was the early epicenter of the COVID-19 pandemic. *Science (New York, N.Y.)*, 377(6609), 951–959.

<https://doi.org/10.1126/science.abp8715>supplemental materials

<sup>679</sup> Gao G, Liu W, Liu P, et al. (2022). Surveillance of SARS-CoV-2 in the environment and animal samples of the Huanan Seafood Market. PREPRINT (Version 1) available at Research Square. <https://doi.org/10.21203/rs.3.rs-1370392/v1>

- <sup>680</sup> Xiao, X., Newman, C., Buesching, C.D. et al. (Jun. 7, 2021). Animal Sales from Wuhan Wet Markets Immediately Prior to the COVID-19 Pandemic. *Scientific Reports*. 11: 11898. <https://doi.org/10.1038/s41598-021-91470-2>
- <sup>681</sup> *Id.* pg 5.
- <sup>682</sup> Worobey, M., Levy, J. I., Malpica Serrano, L., Crits-Christoph, A., Pekar, J. E., Goldstein, S. A., Rasmussen, A. L., Kraemer, M. U. G., Newman, C., Koopmans, M. P. G., Suchard, M. A., Wertheim, J. O., Lemey, P., Robertson, D. L., Garry, R. F., Holmes, E. C., Rambaut, A., & Andersen, K. G. (2022). The Huanan Seafood Wholesale Market in Wuhan was the early epicenter of the COVID-19 pandemic. *Science (New York, N.Y.)*, 377(6609), 951–959. <https://doi.org/10.1126/science.abp8715>
- <sup>683</sup> Gao G, Liu W, Liu P, et al. (2022). Surveillance of SARS-CoV-2 in the environment and animal samples of the Huanan Seafood Market. PREPRINT (Version 1) available at Research Square. <https://doi.org/10.21203/rs.3.rs-1370392/v1>
- <sup>684</sup> Rambaut, A., Holmes, E. C., O’Toole, Á., Hill, V., McCrone, J. T., Ruis, C., du Plessis, L., & Pybus, O. G. (Jul. 15, 2020). A dynamic nomenclature proposal for SARS-CoV-2 lineages to assist genomic epidemiology. *Nature microbiology*, 5(11), 1403–1407. <https://doi.org/10.1038/s41564-020-0770-5>.
- <sup>685</sup> Braun, K. M., Moreno, G. K., Wagner, C., Accola, M. A., Rehrauer, W. M., Baker, D. A., Koelle, K., O’Connor, D. H., Bedford, T., Friedrich, T. C., & Moncla, L. H. (Aug. 23, 2021). Acute SARS-CoV-2 infections harbor limited within-host diversity and transmit via tight transmission bottlenecks. *PLoS Pathogens*, 17(8), e1009849. <https://doi.org/10.1371/journal.ppat.1009849>
- <sup>686</sup> Cohen J. (2020). Mining coronavirus genomes for clues to the outbreak’s origins. *Science*. [Mining coronavirus genomes for clues to the outbreak’s origins | Science | AAAS](https://doi.org/10.1126/science.abp8337)
- <sup>687</sup> Pekar JE, Magee A, Parker E, et al. (Jul. 26, 2022). The Molecular Epidemiology of Multiple Zoonotic Origins of SARS-CoV-2. *Science*. 377(6609):960-966. <https://doi.org/10.1126/science.abp8337>.
- <sup>688</sup> Gao G, Liu W, Liu P, et al. (2022). Surveillance of SARS-CoV-2 in the environment and animal samples of the Huanan Seafood Market. PREPRINT (Version 1) available at Research Square. <https://doi.org/10.21203/rs.3.rs-1370392/v1>
- <sup>689</sup> Pekar, J. E., Magee, A., Parker, E., Moshiri, N., Izhikevich, K., Havens, J. L., Gangavarapu, K., Malpica Serrano, L. M., Crits-Christoph, A., Matteson, N. L., Zeller, M., Levy, J. I., Wang, J. C., Hughes, S., Lee, J., Park, H., Park, M. S., Ching Zi Yan, K., Lin, R. T. P., Mat Isa, M. N., ... Wertheim, J. O. (2022). The molecular epidemiology of multiple zoonotic origins of SARS-CoV-2. *Science (New York, N.Y.)*, 377(6609), 960–966. <https://doi.org/10.1126/science.abp8337>
- <sup>690</sup> Bloom, J.D. (Aug. 16, 2021). Recovery of Deleted Deep Sequencing Data Sheds More Light on the Early Wuhan SARS-CoV-2 Epidemic. *Molecular Biology and Evolution*. 38(12), 2211–2224. <https://doi.org/10.1093/molbev/msab246>.
- <sup>691</sup> Pipes, L., Wang, H., Huelsenbeck, J. P., & Nielsen, R. (Apr. 13, 2021). Assessing Uncertainty in the Rooting of the SARS-CoV-2 Phylogeny. *Molecular Biology and Evolution*, 38(4), 1537–1543. <https://doi.org/10.1093/molbev/msaa316>
- <sup>692</sup> Pekar, J. E., Magee, A., Parker, E., Moshiri, N., Izhikevich, K., Havens, J. L., Gangavarapu, K., Malpica Serrano, L. M., Crits-Christoph, A., Matteson, N. L., Zeller, M., Levy, J. I., Wang, J. C., Hughes, S., Lee, J., Park, H., Park, M. S., Ching Zi Yan, K., Lin, R. T. P., Mat Isa, M. N., ... Wertheim, J. O. (2022). The molecular epidemiology of multiple zoonotic origins of SARS-CoV-2. *Science (New York, N.Y.)*, 377(6609), 960–966. <https://doi.org/10.1126/science.abp8337>
- <sup>693</sup> Gao G, Liu W, Liu P, et al. (2022). Surveillance of SARS-CoV-2 in the environment and animal samples of the Huanan Seafood Market. PREPRINT (Version 1) available at Research Square. <https://doi.org/10.21203/rs.3.rs-1370392/v1>
- <sup>694</sup> *Id.*
- <sup>695</sup> Courtier-Orgogozo, V., de Ribera, F. A. (2022). SARS-CoV-2 infection at the Huanan seafood market. *Environmental research*, 214(Pt 1), 113702. <https://doi.org/10.1016/j.envres.2022.113702>
- <sup>696</sup> The Epidemiological Characteristics of an Outbreak of 2019 Novel Coronavirus Diseases (COVID-19) — China, 2020. *China CDC Weekly*. 2020;2(8):113-122. Source: <https://doi.org/10.46234/ccdcw2020.032>
- <sup>697</sup> *Id.*
- <sup>698</sup> Worobey, M., Levy, J. I., Malpica Serrano, L., Crits-Christoph, A., Pekar, J. E., Goldstein, S. A., Rasmussen, A. L., Kraemer, M. U. G., Newman, C., Koopmans, M. P. G., Suchard, M. A., Wertheim, J. O., Lemey, P., Robertson, D. L., Garry, R. F., Holmes, E. C., Rambaut, A., & Andersen, K. G. (2022). The Huanan Seafood Wholesale Market

in Wuhan was the early epicenter of the COVID-19 pandemic. *Science (New York, N.Y.)*, 377(6609), 951–959.

<https://doi.org/10.1126/science.abp8715>

<sup>699</sup> *Id.*

<sup>700</sup> *Id.*

<sup>701</sup> Xiao, X., Newman, C., Buesching, C.D. et al. (Jun. 7, 2021). Animal Sales from Wuhan Wet Markets Immediately Prior to the COVID-19 Pandemic. *Scientific Reports*. 11: 11898. <https://doi.org/10.1038/s41598-021-91470-2> pg. 5

<sup>702</sup> *Id.*

<sup>703</sup> *Id.*

<sup>704</sup> Worobey, M., Levy, J. I., Malpica Serrano, L., Crits-Christoph, A., Pekar, J. E., Goldstein, S. A., Rasmussen, A. L., Kraemer, M. U. G., Newman, C., Koopmans, M. P. G., Suchard, M. A., Wertheim, J. O., Lemey, P., Robertson, D. L., Garry, R. F., Holmes, E. C., Rambaut, A., & Andersen, K. G. (2022). The Huanan Seafood Wholesale Market in Wuhan was the early epicenter of the COVID-19 pandemic. *Science (New York, N.Y.)*, 377(6609), 951–959.

<https://doi.org/10.1126/science.abp8715>

<sup>705</sup> *Id.*

<sup>706</sup> *Id.*

<sup>707</sup> *Id.*

<sup>708</sup> Gao G, Liu W, Liu P, et al. (2022). Surveillance of SARS-CoV-2 in the environment and animal samples of the Huanan Seafood Market. PREPRINT (Version 1) available at Research Square. <https://doi.org/10.21203/rs.3.rs-1370392/v1> pg.4-5

<sup>709</sup> Worobey, M., Levy, J. I., Malpica Serrano, L., Crits-Christoph, A., Pekar, J. E., Goldstein, S. A., Rasmussen, A. L., Kraemer, M. U. G., Newman, C., Koopmans, M., Suchard, M. A., Wertheim, J. O., Lemey, P., Robertson, D. L., Garry, R. F., Holmes, E. C., Rambaut, A., & Andersen, K. G. (2022). The Huanan Seafood Wholesale Market in Wuhan was the early epicenter of the COVID-19 pandemic. *Science (New York, N.Y.)*, 377(6609), 951–959.

<https://doi.org/10.1126/science.abp8715> supplemental materials

<sup>710</sup> *Id.*

<sup>711</sup> *Id.*

<sup>712</sup> Gao G, Liu W, Liu P, et al. (2022). Surveillance of SARS-CoV-2 in the environment and animal samples of the Huanan Seafood Market. PREPRINT (Version 1) available at Research Square. <https://doi.org/10.21203/rs.3.rs-1370392/v1> et. al.

<sup>713</sup> Worobey, M., Levy, J. I., Malpica Serrano, L., Crits-Christoph, A., Pekar, J. E., Goldstein, S. A., Rasmussen, A. L., Kraemer, M. U. G., Newman, C., Koopmans, M. P. G., Suchard, M. A., Wertheim, J. O., Lemey, P., Robertson, D. L., Garry, R. F., Holmes, E. C., Rambaut, A., & Andersen, K. G. (2022). The Huanan Seafood Wholesale Market in Wuhan was the early epicenter of the COVID-19 pandemic. *Science (New York, N.Y.)*, 377(6609), 951–959.

<https://doi.org/10.1126/science.abp8715>.

<sup>714</sup> Gao G, Liu W, Liu P, et al. (2022). Surveillance of SARS-CoV-2 in the environment and animal samples of the Huanan Seafood Market. PREPRINT (Version 1) available at Research Square. <https://doi.org/10.21203/rs.3.rs-1370392/v1>

<sup>715</sup> Worobey, M., Levy, J. I., Malpica Serrano, L., Crits-Christoph, A., Pekar, J. E., Goldstein, S. A., Rasmussen, A. L., Kraemer, M., Newman, C., Koopmans, M., Suchard, M. A., Wertheim, J. O., Lemey, P., Robertson, D. L., Garry, R. F., Holmes, E. C., Rambaut, A., & Andersen, K. G. (2022). The Huanan Seafood Wholesale Market in Wuhan was the early epicenter of the COVID-19 pandemic. *Science (New York, N.Y.)*, 377(6609), 951–959.

<https://doi.org/10.1126/science.abp8715>

<sup>716</sup> *Id.*

<sup>717</sup> Worobey, M. et al. Zenodo Preprint. [The Huanan market was the epicenter of SARS-CoV-2 emergence | Zenodo](https://zenodo.org/record/6481441) pg. 5

<sup>718</sup> *Id.*

<sup>719</sup> *Id.*

<sup>720</sup> Stoyan D, Chiu S-N. (2022). Statistics cannot prove that the Huanan Seafood Wholesale Market was the early epicenter of the COVID-19 pandemic. <https://arxiv.org/pdf/2208.10106.pdf>

<sup>721</sup> Worobey, M., Levy, J. I., Malpica Serrano, L., Crits-Christoph, A., Pekar, J. E., Goldstein, S. A., Rasmussen, A. L., Kraemer, M., Newman, C., Koopmans, M., Suchard, M. A., Wertheim, J. O., Lemey, P., Robertson, D. L., Garry, R. F., Holmes, E. C., Rambaut, A., & Andersen, K. G. (2022). The Huanan Seafood Wholesale Market in Wuhan was the early epicenter of the COVID-19 pandemic. *Science (New York, N.Y.)*, 377(6609), 951–959.

<https://doi.org/10.1126/science.abp8715> pg 4 (internal citations omitted)

- <sup>722</sup> Pekar, J. E., Magee, A., Parker, E., Moshiri, N., Izhikevich, K., Havens, J. L., Gangavarapu, K., Malpica Serrano, L. M., Crits-Christoph, A., Matteson, N. L., Zeller, M., Levy, J. I., Wang, J. C., Hughes, S., Lee, J., Park, H., Park, M. S., Ching Zi Yan, K., Lin, R. T. P., Mat Isa, M. N., ... Wertheim, J. O. (2022). The molecular epidemiology of multiple zoonotic origins of SARS-CoV-2. *Science (New York, N.Y.)*, 377(6609), 960–966. <https://doi.org/10.1126/science.abp8337>
- <sup>723</sup> World Health Organization. Report of the WHO-China Joint Mission on Coronavirus Disease 2019 (COVID-19) WHO-China Feb. 2020 Report. <https://www.who.int/docs/default-source/coronaviruse/who-china-joint-mission-on-covid-19-final-report.pdf>
- <sup>724</sup> Gao G, Liu W, Liu P, et al. (2022). Surveillance of SARS-CoV-2 in the environment and animal samples of the Huanan Seafood Market. PREPRINT (Version 1) available at Research Square. <https://doi.org/10.21203/rs.3.rs-1370392/v1>
- <sup>725</sup> Li, C., & Chen, H. (Aug. 2, 2021). H7N9 Influenza Virus in China. *Cold Spring Harbor Perspectives in Medicine*, 11(8), a038349. <https://doi.org/10.1101/cshperspect.a038349>
- <sup>726</sup> Chen H. (2009). H5N1 Avian Influenza in China. *Science in China. Series C, Life sciences*, 52(5), 419–427. <https://doi.org/10.1007/s11427-009-0068-6>;
- <sup>727</sup> Edwards, C. E., Yount, B. L., Graham, R. L., Leist, S. R., Hou, Y. J., Dinno, K. H., Sims, A. C., Swanstrom, J., Gully, K., Scobey, T. D., Cooley, M. R., Currie, C. G., Randell, S. H., & Baric, R. S. (Oct. 12, 2020). Swine Acute Diarrhea Syndrome Coronavirus Replication in Primary Human Cells Reveals Potential Susceptibility to Infection. *Proceedings of the National Academy of Sciences*, 117(43), 26915–26925. <https://doi.org/10.1073/pnas.2001046117>
- <sup>728</sup> Li, C., & Chen, H. (Aug. 2, 2021). H7N9 Influenza Virus in China. *Cold Spring Harbor Perspectives in Medicine*, 11(8), a038349. <https://doi.org/10.1101/cshperspect.a038349>
- <sup>729</sup> Gao GF, Liu W, Liu P, Lei W, et al. Surveillance of SARS-CoV-2 in the environment and animal samples of the Huanan Seafood Market. 2022. Research Square. [https://assets.researchsquare.com/files/rs-1370392/v1\\_covered.pdf?c=1645813311](https://assets.researchsquare.com/files/rs-1370392/v1_covered.pdf?c=1645813311)
- <sup>730</sup> World Health Organization. Report of the WHO-China Joint Mission on Coronavirus Disease 2019 (COVID-19) WHO-China Feb. 2020 Report, page 25. <https://www.who.int/docs/default-source/coronaviruse/who-china-joint-mission-on-covid-19-final-report.pdf>
- <sup>731</sup> *Id.*
- <sup>732</sup> *Id.* pg 25-26
- <sup>733</sup> *Id.* pg 26
- <sup>734</sup> *Id.* pg 27
- <sup>735</sup> *Id.* pg 40
- <sup>736</sup> *Id.* Pg 41
- <sup>737</sup> Li, Q., Guan, X., Wu, P., Wang, X., Zhou, L., Tong, Y., Ren, R., Leung, K. S., Lau, E. H., Wong, J. Y., Xing, X., Xiang, N., Wu, Y., Li, C., Chen, Q., Li, D., Liu, T., Zhao, J., Liu, M., . . . Feng, Z. (2020). Early Transmission Dynamics in Wuhan, China, of Novel Coronavirus–Infected Pneumonia. *New England Journal of Medicine*, 382(13), 1199–1207. <https://doi.org/10.1056/nejmoa2001316>.
- <sup>738</sup> Ma, J. (2021, May 10). Exclusive: Coronavirus: China’s first confirmed Covid-19 case traced back to November 17. *South China Morning Post*. <https://www.scmp.com/news/china/society/article/3074991/coronavirus-chinas-first-confirmed-covid-19-case-traced-back>.
- <sup>739</sup> World Health Organization. Report of the WHO-China Joint Mission on Coronavirus Disease 2019 (COVID-19) WHO-China Feb. 2020 Report, page 53. <https://www.who.int/docs/default-source/coronaviruse/who-china-joint-mission-on-covid-19-final-report.pdf>
- <sup>740</sup> *Id.*
- <sup>741</sup> World Health Organization Scientific Advisory Group for the Origins of Novel Pathogens (SAGO). (2022). Preliminary Report. Pg 8. [SAGO Preliminary Report \(who.int\)](#)
- <sup>742</sup> World Health Organization. Report of the WHO-China Joint Mission on Coronavirus Disease 2019 (COVID-19) WHO-China Feb. 2020 Report, page 7. <https://www.who.int/docs/default-source/coronaviruse/who-china-joint-mission-on-covid-19-final-report.pdf>
- <sup>743</sup> World Health Organization Scientific Advisory Group for the Origins of Novel Pathogens (SAGO). (2022). Preliminary Report. Pg. 26-27. [SAGO Preliminary Report \(who.int\)](#)
- <sup>744</sup> Burki T. (Apr. 20, 2022). Dynamic Zero COVID Policy in the Fight Against COVID. *The Lancet. Respiratory Medicine*, 10(6), e58–e59. [https://doi.org/10.1016/S2213-2600\(22\)00142-4](https://doi.org/10.1016/S2213-2600(22)00142-4) .

- <sup>745</sup> Tan, C.C.S., Lam, S.D., Richard, D. et al. (May 27, 2022). Transmission of SARS-CoV-2 from Humans to Animals and Potential Host Adaptation. *Nature Communications*. 13: 2988. <https://doi.org/10.1038/s41467-022-30698-6>.
- <sup>746</sup> Wang, L. F., & Eaton, B. T. (2007). Bats, Civets and the Emergence of SARS. *Current Topics in Microbiology and Immunology*, 315, 325–344. [https://doi.org/10.1007/978-3-540-70962-6\\_13](https://doi.org/10.1007/978-3-540-70962-6_13).
- <sup>747</sup> World Health Organization Scientific Advisory Group for the Origins of Novel Pathogens (SAGO). (2022). Preliminary Report. Pg. 17. [SAGO Preliminary Report \(who.int\)](#)
- <sup>748</sup> *Id.* pg. 100
- <sup>749</sup> WHO-China Report pg 101, see also <https://www.nature.com/articles/d41586-021-02642-z>; Cao, W., Inton, C., Huang, H., and Patton, D. (Sept. 10, 2019). African Swine Fever: China's Pig Industry Crisis. Reuters. <https://graphics.reuters.com/CHINA-SWINEFEVER-FARMERS/010090DR0KM/index.html>; see also Hvistendahl, M. (Apr. 2, 2013). China Deaths Spark Concern About Novel Avian Flu Strain. *Science Insider*. doi: 10.1126/article.26214.
- <sup>750</sup> World Health Organization Scientific Advisory Group for the Origins of Novel Pathogens (SAGO). (2022). Preliminary Report. Pg. 19 & 30. [SAGO Preliminary Report \(who.int\)](#)
- <sup>751</sup> World Health Organization. Report of the WHO-China Joint Mission on Coronavirus Disease 2019 (COVID-19) WHO-China Feb. 2020 Report, page 101. <https://www.who.int/docs/default-source/coronaviruse/who-china-joint-mission-on-covid-19-final-report.pdf>
- <sup>752</sup> *Id.* pg. 102
- <sup>753</sup> *Id.* pg. 103
- <sup>754</sup> *Id.*
- <sup>755</sup> *Id.*
- <sup>756</sup> *Id.*
- <sup>757</sup> *Id.*
- <sup>758</sup> *Id.*
- <sup>759</sup> *Id.* pg. 101
- <sup>760</sup> Zhang, Q., Zhang, H., Huang, K., Yang, Y., Hui, X., Gao, J., He, X., Li, X., Gong, W. Zhang, Y., Peng, C., Gao, X., Chen, H., Zou, Z., Shi, Z., Jin, M. (Apr. 3, 2020). SARS-CoV-2 Neutralizing Serum Antibodies in Cats: a Serological Investigation. *bioRxiv*. 021196. doi: <https://doi.org/10.1101/2020.04.01.021196>.
- <sup>761</sup> *Id.*
- <sup>762</sup> Deng, J., Jin, Y., Liu, Y., Sun, J., Hao, L., Bai, J., Huang, T., Lin, D., Jin, Y., & Tian, K. (2020). Serological Survey of SARS-CoV-2 for Experimental, Domestic, Companion and Wild Animals Excludes Intermediate Hosts of 35 Different Species of Animals. *Transboundary and Emerging Diseases*. 67(4), 1745–1749. <https://doi.org/10.1111/tbed.13577>.
- <sup>763</sup> *Id.*
- <sup>764</sup> World Health Organization Scientific Advisory Group for the Origins of Novel Pathogens (SAGO). (2022). Preliminary Report. Pg. 19 & 30. [SAGO Preliminary Report \(who.int\)](#)
- <sup>765</sup> *Id.*
- <sup>766</sup> *Id.*
- <sup>767</sup> *Id.*
- <sup>768</sup> *Id.*
- <sup>769</sup> Stanway, D. & Tian Y.L. (Dec. 3, 2020). China's Fur Farms See Opportunity as Countries Cull Mink Over Coronavirus Fears. Reuters. <https://www.reuters.com/article/health-coronavirus-china-mink-idINKBN28D0P5>.
- <sup>770</sup> Qiang Zhang Cats Study; British Broadcast Corporation News. (Nov. 15, 2021). China COVID: Outrage After Pet Dog Killed by Health Workers. <https://www.bbc.com/news/world-asia-china-59249485>; see also Beijing Newsroom. (Sept. 29, 2021). Pet Cats Killed in Chinese City After COVID Infection, Triggering Social Media Anger. Reuters. <https://www.reuters.com/world/china/pet-cats-killed-chinese-city-after-covid-infection-triggering-social-media-anger-2021-09-29/>.
- <sup>771</sup> Pang J, Sui T. (2022). Hong Kong to cull 2,000 hamsters after COVID-19 outbreak. Reuters. <https://www.reuters.com/world/china/hong-kong-orders-hamster-cull-after-covid-19-hits-pets-2022-01-18/>
- <sup>772</sup> Yen, H. L., Sit, T. H. C., Brackman, C. J., Chuk, S. S. Y., Gu, H., Tam, K. W. S., Law, P. Y. T., Leung, G. M., Peiris, M., Poon, L. L. M., & HKU-SPH study team (2022). Transmission of SARS-CoV-2 delta variant (AY.127) from pet hamsters to humans, leading to onward human-to-human transmission: a case study. *Lancet (London, England)*, 399(10329), 1070–1078. [https://doi.org/10.1016/S0140-6736\(22\)00326-9](https://doi.org/10.1016/S0140-6736(22)00326-9)

- <sup>773</sup> Conceicao C, Thakur N, Human S, Kelly JT, Logan L, Bialy D, et al. (Dec. 21, 2020) The SARS-CoV-2 Spike protein has a broad tropism for mammalian ACE2 proteins. *PLoS Biol* 18(12): e3001016. <https://doi.org/10.1371/journal.pbio.3001016>
- <sup>774</sup> Conceicao C, Thakur N, Human S, Kelly JT, Logan L, Bialy D, et al. (Dec. 21, 2020) The SARS-CoV-2 Spike protein has a broad tropism for mammalian ACE2 proteins. *PLoS Biol* 18(12): e3001016. <https://doi.org/10.1371/journal.pbio.3001016>
- <sup>775</sup> China-WHO Report pg 115
- <sup>776</sup> World Health Organization Scientific Advisory Group for the Origins of Novel Pathogens (SAGO). (2022). Preliminary Report. Pg. 21-21. [SAGO Preliminary Report \(who.int\)](https://www.who.int/publications/m/item/sago-preliminary-report)
- <sup>777</sup> *Id.*
- <sup>778</sup> Xiao, X., Newman, C., Buesching, C.D. et al. (Jun. 7, 2021). Animal Sales from Wuhan Wet Markets Immediately Prior to the COVID-19 Pandemic. *Scientific Reports*. 11: 11898. <https://doi.org/10.1038/s41598-021-91470-2>
- <sup>779</sup> *Id.*
- <sup>780</sup> Shi, Z., & Hu, Z. (2008). A review of studies on animal reservoirs of the SARS coronavirus. *Virus research*, 133(1), 74–87. <https://doi.org/10.1016/j.virusres.2007.03.012>
- <sup>781</sup> Wolters, W. J., de Rooij, M. M. T., Molenaar, R. J., de Rond, J., Vernooij, J. C. M., Meijer, P. A., Oude Munnink, B. B., Sikkema, R. S., van der Spek, A. N., Spiereburg, M. A. H., Hakze-van der Honing, R. W., van der Poel, W. H. M., Koopmans, M. P. G., Stegeman, J. A., Smit, L. A. M., Augustijn-Schretlen, M., & Velkers, F. C. (2022). Manifestation of SARS-CoV-2 Infections in Mink Related to Host-, Virus- and Farm-Associated Factors, The Netherlands 2020. *Viruses*, 14(8), 1754. <https://doi.org/10.3390/v14081754>
- <sup>782</sup> Sharun, K., Tiwari, R., Natesan, S., & Dhama, K. (Jan. 18, 2021). SARS-CoV-2 Infection in Farmed Minks, Associated Zoonotic Concerns, and Importance of the One Health Approach During the Ongoing COVID-19 Pandemic. *The Veterinary Quarterly*. 41(1): 50–60. <https://doi.org/10.1080/01652176.2020.1867776>
- <sup>783</sup> Oreshkova N., Molenaar R. J., Vreman S., Harders F., Oude M. B. B, Hakze-van der Honing R. W., Gerhards N., Tolsma P., Bouwstra R., Sikkema R. S., Tacken Mirriam GJ, de Rooij M. MT, Weesendorp E., Engelsma M.Y., Brusckhe C. JM., Smit L. AM, Koopmans M., van der Poel W. HM., Stegeman A.. (June 4, 2020). SARS-CoV-2 Infection in Farmed Minks, the Netherlands, April and May 2020. *Euro Surveill*. 2020;25(23):pii=2001005. <https://doi.org/10.2807/1560-7917.ES.2020.25.23.2001005>.
- <sup>784</sup> *Id.*
- <sup>785</sup> Pomorska-Mól, M., Włodarek, J., Gogulski, M., & Rybska, M. (Jul. 11, 2021). Review: SARS-CoV-2 Infection in Farmed Minks - an Overview of Current Knowledge on Occurrence, Disease and Epidemiology. *Animal: an International Journal of Animal Bioscience*. 15(7): 100272. <https://doi.org/10.1016/j.animal.2021.100272>
- <sup>786</sup> Oreshkova N., Molenaar R. J., Vreman S., Harders F., Oude M. B. B, Hakze-van der Honing R. W., Gerhards N., Tolsma P., Bouwstra R., Sikkema R. S., Tacken Mirriam GJ, de Rooij M. MT, Weesendorp E., Engelsma M.Y., Brusckhe C. JM., Smit L. AM, Koopmans M., van der Poel W. HM., Stegeman A.. (June 4, 2020). SARS-CoV-2 Infection in Farmed Minks, the Netherlands, April and May 2020. *Euro Surveill*. 2020;25(23):pii=2001005. <https://doi.org/10.2807/1560-7917.ES.2020.25.23.2001005>
- <sup>787</sup> *Id.*
- <sup>788</sup> Pomorska-Mól, M., Włodarek, J., Gogulski, M., & Rybska, M. (Jul. 11, 2021). Review: SARS-CoV-2 Infection in Farmed Minks - an Overview of Current Knowledge on Occurrence, Disease and Epidemiology. *Animal: an International Journal of Animal Bioscience*. 15(7): 100272. <https://doi.org/10.1016/j.animal.2021.100272>
- <sup>789</sup> *Id.*
- <sup>790</sup> *Id.*
- <sup>791</sup> *Id.*
- <sup>792</sup> Fenollar, F., Mediannikov, O., Maurin, M., Devaux, C., Colson, P., Levasseur, A., Fournier, P. E., & Raoult, D. (Apr. 1, 2021). Mink, SARS-CoV-2, and the Human-Animal Interface. *Frontiers in Microbiology*, 12. <https://doi.org/10.3389/fmicb.2021.663815>.
- <sup>793</sup> *Id.*
- <sup>794</sup> *Id.*
- <sup>795</sup> Rasmussen TB, Fonager J, Jørgensen CS, Lassaunière R, Hammer AS, et al. (Nov. 15, 2021) Infection, Recovery and Re-Infection of farmed Mink with SARS-CoV-2. *PLOS Pathogens*. 17(11): e1010068. <https://doi.org/10.1371/journal.ppat.1010068>
- <sup>796</sup> Oude Munnink, B. B., Sikkema, R. S., Nieuwenhuijse, D. F., Molenaar, R. J., Munger, E., Molenkamp, R., van der Spek, A., Tolsma, P., Rietveld, A., Brouwer, M., Bouwmeester-Vincken, N., Harders, F., Hakze-van der Honing,



- R., Wegdam-Blans, M. C. A., Bouwstra, R. J., GeurtsvanKessel, C., van der Eijk, A. A., Velkers, F. C., Smit, L. A. M., Stegeman, A., ... Koopmans, M. P. G. (2021). Transmission of SARS-CoV-2 on mink farms between humans and mink and back to humans. *Science (New York, N.Y.)*, 371(6525), 172–177. <https://doi.org/10.1126/science.abe5901>
- <sup>797</sup> *Id.*
- <sup>798</sup> *Id.*
- <sup>799</sup> *Id.*
- <sup>800</sup> European Centre for Disease Prevention and Control. Detection of new SARS-CoV-2 variants related to mink – 12 November 2020. ECDC: Stockholm; 2020. <https://www.ecdc.europa.eu/sites/default/files/documents/RRA-SARS-CoV-2-in-mink-12-nov-2020.pdf>.
- <sup>801</sup> Murray, Adrienne. Coronavirus: Denmark Shaken by Cull of Millions of Mink. British Broadcasting Corporation. <https://www.bbc.com/news/world-europe-54890229>.
- <sup>802</sup> Fenollar, F., Mediannikov, O., Maurin, M., Devaux, C., Colson, P., Levasseur, A., Fournier, P. E., & Raoult, D. (Apr. 1, 2021). Mink, SARS-CoV-2, and the Human-Animal Interface. *Frontiers in Microbiology*, 12. <https://doi.org/10.3389/fmicb.2021.663815>
- <sup>803</sup> Lung, Yuan-Chin & Lin Sophie. (July 2019). China's Fur Trade and Its Position in the Global Fur Industry. Act Asia. <https://www.actasia.org/wp-content/uploads/2019/10/China-Fur-Report-7.5.pdf>.
- <sup>804</sup> *Id.*
- <sup>805</sup> *Id.*
- <sup>806</sup> Liting B., Petry M. (May 25, 2010). Fur and Animal Products, People's Republic of China. United States Department of Agriculture, Foreign Agricultural Service, Global Agricultural Information Network (GAIN). [https://apps.fas.usda.gov/newgainapi/api/report/downloadreportbyfilename?filename=Fur%20Animals%20and%20Products\\_Beijing\\_China%20-%20%20Peoples%20Republic%20of\\_5-25-2010.pdf](https://apps.fas.usda.gov/newgainapi/api/report/downloadreportbyfilename?filename=Fur%20Animals%20and%20Products_Beijing_China%20-%20%20Peoples%20Republic%20of_5-25-2010.pdf)
- <sup>807</sup> Act Asia Report, *supra* note 162
- <sup>808</sup> *Id.*
- <sup>809</sup> *Id.*
- <sup>810</sup> *Id.*
- <sup>811</sup> *Id.*
- <sup>812</sup> *Id.*
- <sup>813</sup> *Id.*
- <sup>813</sup> *Id.*
- <sup>814</sup> USDA, *supra* note 164
- <sup>815</sup> *Id.*
- <sup>816</sup> Act Asia Report, *supra* note 162
- <sup>817</sup> *Id.*
- <sup>818</sup> *Id.*
- <sup>819</sup> *Id.*
- <sup>820</sup> *Id.*
- <sup>821</sup> WHO-China Joint Report Annex C6 pg. 98-99 <https://www.who.int/docs/default-source/coronaviruse/who-convened-global-study-of-origins-of-sars-cov-2-china-part-annexes.pdf> .
- <sup>822</sup> *Id.*
- <sup>823</sup> *Id.*
- <sup>824</sup> Worobey, M., Levy, J. I., Malpica Serrano, L., Crits-Christoph, A., Pekar, J. E., Goldstein, S. A., Rasmussen, A. L., Kraemer, M. U. G., Newman, C., Koopmans, M. P. G., Suchard, M. A., Wertheim, J. O., Lemey, P., Robertson, D. L., Garry, R. F., Holmes, E. C., Rambaut, A., & Andersen, K. G. (2022). The Huanan Seafood Wholesale Market in Wuhan was the early epicenter of the COVID-19 pandemic. *Science (New York, N.Y.)*, 377(6609), 951–959. <https://doi.org/10.1126/science.abp8715>
- <sup>825</sup> Temmam, S., Vongphayloth, K., Baquero, E. et al. (Feb. 8, 2022). Bat Coronaviruses Related to SARS-CoV-2 and Infectious for Human Cells. *Nature*. 604, 330–336. <https://doi.org/10.1038/s41586-022-04532-4>
- <sup>826</sup> Hu B, Zeng LP, Yang XL, Ge XY, Zhang W, et al. (2017) Discovery of a Rich Gene Pool of Bat SARS-Related Coronaviruses Provides new Insights into the origin of SARS Coronavirus. *PLOS Pathogens* 13(11): e1006698. <https://doi.org/10.1371/journal.ppat.1006698>; see also Wang, N., Li, S. Y., Yang, X. L., Huang, H. M., Zhang, Y. J., Guo, H., Luo, C. M., Miller, M., Zhu, G., Chmura, A. A., Hagan, E., Zhou, J. H., Zhang, Y. Z., Wang, L. F., Daszak, P., & Shi, Z. L. (2018). Serological Evidence of Bat SARS-Related Coronavirus Infection in Humans, China. *Virologica Sinica*. 33(1), 104–107. <https://doi.org/10.1007/s12250-018-0012-7>.

- <sup>827</sup> Worobey, M., Levy, J. I., Malpica Serrano, L., Crits-Christoph, A., Pekar, J. E., Goldstein, S. A., Rasmussen, A. L., Kraemer, M. U. G., Newman, C., Koopmans, M. P. G., Suchard, M. A., Wertheim, J. O., Lemey, P., Robertson, D. L., Garry, R. F., Holmes, E. C., Rambaut, A., & Andersen, K. G. (2022). The Huanan Seafood Wholesale Market in Wuhan was the early epicenter of the COVID-19 pandemic. *Science (New York, N.Y.)*, 377(6609), 951–959. <https://doi.org/10.1126/science.abp8715>
- <sup>828</sup> WHO-China Joint Report (2020). <https://www.who.int/docs/default-source/coronaviruse/who-china-joint-mission-on-covid-19-final-report.pdf>
- <sup>829</sup> Worobey, M., Levy, J. I., Malpica Serrano, L., Crits-Christoph, A., Pekar, J. E., Goldstein, S. A., Rasmussen, A. L., Kraemer, M. U. G., Newman, C., Koopmans, M. P. G., Suchard, M. A., Wertheim, J. O., Lemey, P., Robertson, D. L., Garry, R. F., Holmes, E. C., Rambaut, A., & Andersen, K. G. (2022). The Huanan Seafood Wholesale Market in Wuhan was the early epicenter of the COVID-19 pandemic. *Science (New York, N.Y.)*, 377(6609), 951–959. <https://doi.org/10.1126/science.abp8715>
- <sup>830</sup> World Health Organization Scientific Advisory Group for the Origins of Novel Pathogens (SAGO). (2022). Preliminary Report. [SAGO Preliminary Report \(who.int\)](https://www.who.int/docs/default-source/sago-preliminary-report-2022/sago-preliminary-report-2022.pdf)
- <sup>831</sup> Worobey, M., Levy, J. I., Malpica Serrano, L., Crits-Christoph, A., Pekar, J. E., Goldstein, S. A., Rasmussen, A. L., Kraemer, M. U. G., Newman, C., Koopmans, M. P. G., Suchard, M. A., Wertheim, J. O., Lemey, P., Robertson, D. L., Garry, R. F., Holmes, E. C., Rambaut, A., & Andersen, K. G. (2022). The Huanan Seafood Wholesale Market in Wuhan was the early epicenter of the COVID-19 pandemic. *Science (New York, N.Y.)*, 377(6609), 951–959. <https://doi.org/10.1126/science.abp8715>
- <sup>832</sup> Wang, L. F., & Eaton, B. T. (2007). Bats, Civets and the Emergence of SARS. *Current Topics in Microbiology and Immunology*, 315, 325–344. [https://doi.org/10.1007/978-3-540-70962-6\\_13](https://doi.org/10.1007/978-3-540-70962-6_13).
- <sup>833</sup> Mouton, Christopher A., Russell Hanson, Adam R. Grissom, and John P. Godges. (2020). COVID-19 Air Traffic Visualization: By January 31, 2020, at Least 1.5 Daily Infected Passengers Were Originating in China. RAND Corporation. [https://www.rand.org/pubs/research\\_reports/RRA248-2.html](https://www.rand.org/pubs/research_reports/RRA248-2.html).
- <sup>834</sup> Lau, S., Wong, A., Luk, H., Li, K., Fung, J., He, Z...Woo, P. (2020). Differential Tropism of SARS-CoV and SARS-CoV-2 in Bat Cells. *Emerging Infectious Diseases*, 26(12), 2961–2965. <https://doi.org/10.3201/eid2612.202308>.
- <sup>835</sup> Lytras S, Xia W, Hughes J, Jiang X, Robertson DL. (Aug. 17. 2021). The animal origin of SARS-CoV-2. *Science*. 373(6558):968-970. <https://doi.org/10.1126/science.abh0117>.
- <sup>836</sup> Holmes, E. C., Goldstein, S. A., Rasmussen, A. L., Robertson, D. L., Crits-Christoph, A., Wertheim, J. O., Anthony, S. J., Barclay, W. S., Boni, M. F., Doherty, P. C., Farrar, J., Geoghegan, J. L., Jiang, X., Leibowitz, J. L., Neil, S. J., Skern, T., Weiss, S. R., Worobey, M., Andersen, K. G., . . . Rambaut, A. (2021). The origins of SARS-CoV-2: A critical review. *Cell*, 184(19), 4848–4856. <https://doi.org/10.1016/j.cell.2021.08.017>
- <sup>837</sup> Arné de Klerk, Phillip Swanepoel, Rentia Lourens, Mpumelelo Zondo, Isaac Abodunran, Spyros Lytras, Oscar A MacLean, David Robertson, Sergei L Kosakovsky Pond, Jordan D Zehr, Venkatesh Kumar, Michael J Stanhope, Gordon Harkins, Ben Murrell, Darren P Martin. (2022). Conserved Recombination Patterns Across Coronavirus Subgenera, *Virus Evolution*. 8(2) veac054. <https://doi.org/10.1093/ve/veac054>.
- <sup>838</sup> Rambaut, A., Holmes, E. C., O’Toole, Á., Hill, V., McCrone, J. T., Ruis, C., du Plessis, L., & Pybus, O. G. et al. ; *see also* World Health Organization. (Mar. 26, 2020). Origin of SARS-CoV-2. [https://apps.who.int/iris/bitstream/handle/10665/332197/WHO-2019-nCoV-FAQ-Virus\\_origin-2020.1-eng.pdf](https://apps.who.int/iris/bitstream/handle/10665/332197/WHO-2019-nCoV-FAQ-Virus_origin-2020.1-eng.pdf).
- <sup>839</sup> Lau, Susanna KP, Hayes KH Luk, Antonio CP Wong, Kenneth SM Li, Longchao Zhu, Zirong He, Joshua Fung, Tony TY Chan, Kitty SC Fung, and Patrick CY Woo. (2020). Possible bat origin of severe acute respiratory syndrome coronavirus 2. *Emerging Infectious Diseases*. 26(7): 1542.
- <sup>840</sup> [Act Asia Report, supra note 162.](#)
- <sup>841</sup> Hubei Daily. (Feb. 3, 2020). Enshi Seals Up 290 Artificial Breeding Sites for Wild Animals. Jingchu Net. [http://news.cnhubei.com/content/2020-02/03/content\\_12677100.html](http://news.cnhubei.com/content/2020-02/03/content_12677100.html); *see also* Staendert, M., & Dou, E. (2021, October 11). In Search for Coronavirus Origins, Hubei Caves and Wildlife Farms Draw New Scrutiny. Washington Post. [https://www.washingtonpost.com/world/asia\\_pacific/china-covid-bats-caves-hubei/2021/10/10/082eb8b6-1c32-11ec-bea8-308ea134594f\\_story.html](https://www.washingtonpost.com/world/asia_pacific/china-covid-bats-caves-hubei/2021/10/10/082eb8b6-1c32-11ec-bea8-308ea134594f_story.html).
- <sup>842</sup> *Id.*
- <sup>843</sup> Office of the Director of National Intelligence. (2021). Updated Assessment on COVID-19 Origins. <https://www.dni.gov/files/ODNI/documents/assessments/Declassified-Assessment-on-COVID-19-Origins.pdf>.
- <sup>844</sup> Worobey, M., Levy, J. I., Malpica Serrano, L., Crits-Christoph, A., Pekar, J. E., Goldstein, S. A., Rasmussen, A. L., Kraemer, M. U. G., Newman, C., Koopmans, M. P. G., Suchard, M. A., Wertheim, J. O., Lemey, P., Robertson, D. L., Garry, R. F., Holmes, E. C., Rambaut, A., & Andersen, K. G. (2022). The Huanan Seafood Wholesale Market

in Wuhan was the early epicenter of the COVID-19 pandemic. *Science (New York, N.Y.)*, 377(6609), 951–959.

<https://doi.org/10.1126/science.abp8715>

<sup>845</sup> WHO-China Joint Report

<sup>846</sup> Worobey, M., Levy, J. I., Malpica Serrano, L., Crits-Christoph, A., Pekar, J. E., Goldstein, S. A., Rasmussen, A. L., Kraemer, M. U. G., Newman, C., Koopmans, M. P. G., Suchard, M. A., Wertheim, J. O., Lemey, P., Robertson, D. L., Garry, R. F., Holmes, E. C., Rambaut, A., & Andersen, K. G. (2022). The Huanan Seafood Wholesale Market in Wuhan was the early epicenter of the COVID-19 pandemic. *Science (New York, N.Y.)*, 377(6609), 951–959.

<https://doi.org/10.1126/science.abp8715>

<sup>847</sup> WHO-China Report pg 98-99

<sup>848</sup> McCarthey, S. (June 9, 2021.). Coronavirus: Thousands of wild animals were sold at Wuhan markets in months before Covid-19 outbreak, new report finds. South China Morning Post.

<https://www.scmp.com/news/china/science/article/3136674/thousands-wild-animals-were-sold-wuhan-markets-months-covid-19>

<sup>849</sup> Xiao, X., Newman, C., Buesching, C.D. et al. (Jun. 7, 2021). Animal Sales from Wuhan Wet Markets Immediately Prior to the COVID-19 Pandemic. *Scientific Reports*. 11: 11898. <https://doi.org/10.1038/s41598-021-91470-2>

<sup>850</sup> Worobey, M., Levy, J. I., Malpica Serrano, L., Crits-Christoph, A., Pekar, J. E., Goldstein, S. A., Rasmussen, A. L., Kraemer, M. U. G., Newman, C., Koopmans, M. P. G., Suchard, M. A., Wertheim, J. O., Lemey, P., Robertson, D. L., Garry, R. F., Holmes, E. C., Rambaut, A., & Andersen, K. G. (2022). The Huanan Seafood Wholesale Market in Wuhan was the early epicenter of the COVID-19 pandemic. *Science (New York, N.Y.)*, 377(6609), 951–959.

<https://doi.org/10.1126/science.abp8715>

<sup>851</sup> WHO-China Report pg 98-99

<sup>852</sup> *Id.*

<sup>853</sup> Zhang, Y. The Novel Coronavirus Pneumonia Emergency Response Epidemiology Team (2020). The Epidemiological Characteristics of an Outbreak of 2019 Novel Coronavirus Diseases (COVID-19) — China, 2020

<https://weekly.chinacdc.cn/en/article/id/e53946e2-c6c4-41e9-9a9b-fea8db1a8f51>

<sup>854</sup> Edwards, C. E., Yount, B. L., Graham, R. L., Leist, S. R., Hou, Y. J., Dinnon, K. H., 3rd, Sims, A. C., Swanstrom, J., Gully, K., Scobey, T. D., Cooley, M. R., Currie, C. G., Randell, S. H., & Baric, R. S. (2020). Swine acute diarrhea syndrome coronavirus replication in primary human cells reveals potential susceptibility to infection. *Proceedings of the National Academy of Sciences of the United States of America*, 117(43), 26915–26925.

<https://doi.org/10.1073/pnas.2001046117>

<sup>855</sup> World Health Organization. (2020). Origins of SARS-CoV-2.

[https://apps.who.int/iris/bitstream/handle/10665/332197/WHO-2019-nCoV-FAQ-Virus\\_origin-2020.1-eng.pdf](https://apps.who.int/iris/bitstream/handle/10665/332197/WHO-2019-nCoV-FAQ-Virus_origin-2020.1-eng.pdf)

<sup>856</sup> Worobey, M., Levy, J. I., Malpica Serrano, L., Crits-Christoph, A., Pekar, J. E., Goldstein, S. A., Rasmussen, A. L., Kraemer, M. U. G., Newman, C., Koopmans, M. P. G., Suchard, M. A., Wertheim, J. O., Lemey, P., Robertson, D. L., Garry, R. F., Holmes, E. C., Rambaut, A., & Andersen, K. G. (2022). The Huanan Seafood Wholesale Market in Wuhan was the early epicenter of the COVID-19 pandemic. *Science (New York, N.Y.)*, 377(6609), 951–959.

<https://doi.org/10.1126/science.abp8715>

<sup>857</sup> WHO-China Joint Report *see also*: <https://weekly.chinacdc.cn/en/article/id/e53946e2-c6c4-41e9-9a9b-fea8db1a8f51>

<sup>858</sup> WHO-China Joint Report 98-99

<sup>859</sup> Zeller, M., Gangavarapu, K., Anderson, C., Smither, A. R., Vanchiere, J. A., Rose, R., Snyder, D. J., Dudas, G., Watts, A., Matteson, N. L., Robles-Sikisaka, R., Marshall, M., Feehan, A. K., Sabino-Santos, G., Jr, Bell-Kareem, A. R., Hughes, L. D., Alkuzweny, M., Snarski, P., Garcia-Diaz, J., Scott, R. S., ... Andersen, K. G. (2021). Emergence of an early SARS-CoV-2 epidemic in the United States. *medRxiv : the preprint server for health sciences*, 2021.02.05.21251235. <https://doi.org/10.1101/2021.02.05.21251235>

<sup>860</sup> WHO-China Report pg. 98-99

<sup>861</sup> WHO-China Joint Report; *see also* <https://www.mdpi.com/2220-9964/9/6/402>

<sup>862</sup> Gao, George & Liu, William & Liu, Peipei & Lei, Wenwen & Jia, Zhiyuan & He, Xiaozhou & Liu, Lin-Lin & Shi, Weifeng & Tan, Yun & Zou, Shumei & Zhao, Xiang & Wong, Gary & Wang, Ji & Wang, Feng & Wang, Gang & Qin, Kun & Gao, Rong-bao & Zhang, Jie & Li, Min & Wu, Guizhen. (Feb. 25, 2022). Surveillance of SARS-CoV-2 in the environment and animal samples of the Huanan Seafood Market. Research Square.

<https://doi.org/10.21203/rs.3.rs-1370392/v1>

<sup>863</sup> *Id.*

<sup>864</sup> Dynamic [Nomenclature](#)

- <sup>865</sup>Pomorska-Mól, M., Włodarek, J., Gogulski, M., & Rybska, M. (Jul. 11, 2021). Review: SARS-CoV-2 Infection in Farmed Minks - an Overview of Current Knowledge on Occurrence, Disease and Epidemiology. *Animal: an International Journal of Animal Bioscience*. 15(7): 100272. <https://doi.org/10.1016/j.animal.2021.100272>.
- <sup>866</sup> Wang, L. F., & Eaton, B. T. (2007). Bats, civets and the emergence of SARS. *Current topics in microbiology and immunology*, 315, 325–344. [https://doi.org/10.1007/978-3-540-70962-6\\_13](https://doi.org/10.1007/978-3-540-70962-6_13)
- <sup>867</sup> *Id.*
- <sup>868</sup> SARS: How a Global Epidemic was Stopped, WHO pg 35  
[https://apps.who.int/iris/bitstream/handle/10665/207501/9290612134\\_eng.pdf](https://apps.who.int/iris/bitstream/handle/10665/207501/9290612134_eng.pdf)
- <sup>869</sup> Ellwanger, J. H., & Chies, J. (2021). Zoonotic spillover: Understanding basic aspects for better prevention. *Genetics and molecular biology*, 44(1 Suppl 1), e20200355. <https://doi.org/10.1590/1678-4685-GMB-2020-0355>
- <sup>870</sup> Letko, M., Seifert, S. N., Olival, K. J., Plowright, R. K., & Munster, V. J. (2020). Bat-borne virus diversity, spillover and emergence. *Nature reviews. Microbiology*, 18(8), 461–471. <https://doi.org/10.1038/s41579-020-0394-z>
- <sup>871</sup> Wang, N., Li, S. Y., Yang, X. L., Huang, H. M., Zhang, Y. J., Guo, H., Luo, C. M., Miller, M., Zhu, G., Chmura, A. A., Hagan, E., Zhou, J. H., Zhang, Y. Z., Wang, L. F., Daszak, P., & Shi, Z. L. (2018). Serological Evidence of Bat SARS-Related Coronavirus Infection in Humans, China. *Virologica Sinica*, 33(1), 104–107. <https://doi.org/10.1007/s12250-018-0012-7>.
- <sup>872</sup> *Id.*
- <sup>873</sup> *Id.*
- <sup>874</sup> *Id.*
- <sup>875</sup> Focosi, D. et al., *supra* note 228.
- <sup>876</sup> WHO-China Joint Report
- <sup>877</sup> Temmam, S., Vongphayloth, K., Baquero, E. et al. Bat coronaviruses related to SARS-CoV-2 and infectious for human cells. *Nature* **604**, 330–336 (2022). <https://doi.org/10.1038/s41586-022-04532-4>
- <sup>878</sup> Temmam, S., Montagutelli, X. Hérate, C. et al. SARS-CoV-2-Related Bat Virus in Human Relevant Models Sheds Light on the Proximal Origin of COVID-19, 30 June 2022, PREPRINT (Version 1) available at Research Square. <https://doi.org/10.21203/rs.3.rs-1803095/v1>
- <sup>879</sup> *Id.*
- <sup>880</sup> V'kovski, P., Kratzel, A., Steiner, S. et al. Coronavirus biology and replication: implications for SARS-CoV-2. *Nat Rev Microbiol* **19**, 155–170 (2021). <https://doi.org/10.1038/s41579-020-00468-6>
- <sup>881</sup> Temman, *supra* note 860.
- <sup>882</sup> *Id.*
- <sup>883</sup> *Id.*
- <sup>884</sup> *Id.*
- <sup>885</sup> WHO-China Joint Report Pg 98-99
- <sup>886</sup> Damas, J., Hughes, G. M., Keough, K. C., Painter, C. A., Persky, N. S., Corbo, M., Hiller, M., Koepfli, K. P., Pfenning, A. R., Zhao, H., Genereux, D. P., Swofford, R., Pollard, K. S., Ryder, O. A., Nweeia, M. T., Lindblad-Toh, K., Teeling, E. C., Karlsson, E. K., & Lewin, H. A. (2020). Broad host range of SARS-CoV-2 predicted by comparative and structural analysis of ACE2 in vertebrates. *Proceedings of the National Academy of Sciences*, 117(36), 22311–22322. <https://doi.org/10.1073/pnas.2010146117> see also Fenollar, F., Mediannikov, O., Maurin, M., Devaux, C et al.
- <sup>887</sup> Discovery of a Rich Gene Pool of Bat SARS-Related Coronaviruses, *supra* note 184; see also Wang, N., Li, S. Y., Yang, X. L., Huang, H. M., Zhang, Y. J., Guo, H., Luo, C. M., Miller, M., Zhu, G., Chmura, A. A., Hagan, E., Zhou, J. H., Zhang, Y. Z., Wang, L. F., Daszak, P., & Shi, Z. L. (2018). Serological Evidence of Bat SARS-Related Coronavirus Infection in Humans, China. *Virologica Sinica*, 33(1), 104–107. <https://doi.org/10.1007/s12250-018-0012-7>
- <sup>888</sup> Focosi, D. et al., *supra* note 228.
- <sup>889</sup> Most Coronavirus Cases Are Mild. That's Good and Bad News. The New York Times. <https://www.nytimes.com/2020/02/27/world/asia/coronavirus-treatment-recovery.html>.
- <sup>890</sup> Li, W., Shi, Z., Yu, M., Ren, W., Smith, C., Epstein, J. H., Wang, H., Crameri, G., Hu, Z., Zhang, H., Zhang, J., McEachern, J., Field, H., Daszak, P., Eaton, B. T., Zhang, S., & Wang, L. F. (2005). Bats are Natural Reservoirs of SARS-Like Coronaviruses. *Science*. 310(5748), 676–679. <https://doi.org/10.1126/science.1118391>
- <sup>891</sup> BurrNIH-00000
- <sup>892</sup> Discovery of a Rich Gene Pool of Bat SARS-Related Coronaviruses, *supra* note 184

- <sup>893</sup> Mafalda Viana, Rebecca Mancy, Roman Biek, Sarah Cleaveland, Paul C. Cross, James O. Lloyd-Smith, Daniel T. Haydon. (May 2014). Assembling Evidence for Identifying Reservoirs of Infection. *Trends in Ecology & Evolution*. 29(5), 270–279. <https://doi.org/10.1016/j.tree.2014.03.002>.
- <sup>894</sup> Koch, L.K., Cunze, S., Kochmann, J. *et al.* Bats as putative *Zaire ebolavirus* reservoir hosts and their habitat suitability in Africa. *Sci Rep* **10**, 14268 (2020). <https://doi.org/10.1038/s41598-020-71226-0>; Sharp, P. M., & Hahn, B. H. (2011). Origins of HIV and the AIDS pandemic. *Cold Spring Harbor perspectives in medicine*, 1(1), a006841. <https://doi.org/10.1101/cshperspect.a006841>
- <sup>895</sup> The-nCoV Outbreak Joint Field Epidemiology Investigation Team, Li, Q. (2020). An Outbreak of NCIP (2019-nCoV) Infection in China - Wuhan, Hubei Province, 2019-2020. *China CDC weekly*, 2(5), 79–80. [An Outbreak of NCIP \(2019-nCoV\) Infection in China — Wuhan, Hubei Province, 2019–2020 - PMC \(nih.gov\)](https://doi.org/10.1181/0493-1082.202005079)
- <sup>896</sup> Worobey, M., Levy, J. I., Malpica Serrano, L., Crits-Christoph, A., Pekar, J. E., Goldstein, S. A., Rasmussen, A. L., Kraemer, M. U. G., Newman, C., Koopmans, M. P. G., Suchard, M. A., Wertheim, J. O., Lemey, P., Robertson, D. L., Garry, R. F., Holmes, E. C., Rambaut, A., & Andersen, K. G. (2022). The Huanan Seafood Wholesale Market in Wuhan was the early epicenter of the COVID-19 pandemic. *Science (New York, N.Y.)*, 377(6609), 951–959. <https://doi.org/10.1126/science.abp8715>
- <sup>897</sup> WHO-China Joint Report
- <sup>898</sup> Worobey, M., Levy, J. I., Malpica Serrano, L., Crits-Christoph, A., Pekar, J. E., Goldstein, S. A., Rasmussen, A. L., Kraemer, M. U. G., Newman, C., Koopmans, M. P. G., Suchard, M. A., Wertheim, J. O., Lemey, P., Robertson, D. L., Garry, R. F., Holmes, E. C., Rambaut, A., & Andersen, K. G. (2022). The Huanan Seafood Wholesale Market in Wuhan was the early epicenter of the COVID-19 pandemic. *Science (New York, N.Y.)*, 377(6609), 951–959. <https://doi.org/10.1126/science.abp8715>.
- <sup>899</sup> Xiao, X., Newman, C., Buesching, C.D. *et al.* (Jun. 7, 2021). Animal Sales from Wuhan Wet Markets Immediately Prior to the COVID-19 Pandemic. *Scientific Reports*. 11: 11898. <https://doi.org/10.1038/s41598-021-91470-2> *et al.*
- <sup>900</sup> WHO-China Joint Report
- <sup>901</sup> Worobey, M., Levy, J. I., Malpica Serrano, L., Crits-Christoph, A., Pekar, J. E., Goldstein, S. A., Rasmussen, A. L., Kraemer, M. U. G., Newman, C., Koopmans, M. P. G., Suchard, M. A., Wertheim, J. O., Lemey, P., Robertson, D. L., Garry, R. F., Holmes, E. C., Rambaut, A., & Andersen, K. G. (2022). The Huanan Seafood Wholesale Market in Wuhan was the early epicenter of the COVID-19 pandemic. *Science (New York, N.Y.)*, 377(6609), 951–959. <https://doi.org/10.1126/science.abp8715>
- <sup>902</sup> *Id.*
- <sup>903</sup> Gao G, Liu W, Liu P, *et al.* Surveillance of SARS-CoV-2 in the environment and animal samples of the Huanan Seafood Market [Internet]. Research Square. 2022; <https://www.researchsquare.com/article/rs-1370392/latest.pdf>
- <sup>904</sup> Crits-Christoph, A., Gangavarapu, K., Pekar, J.E., Moshiri, N., Singh, R., Levy, J.I., Goldstein, S.A., Suchard, M.A., Popescu, S., Robertson, D.L., Lemey, P., Wertheim, J.O., Garry, R.F., Rasmussen, A.L., Andersen, K.G., Holmes, E.C., Rambaut, A., Worobey, M., & Débarre, F. (2023). Genetic evidence of susceptible wildlife in SARS-CoV-2 positive samples at the Huanan Wholesale Seafood Market, Wuhan: Analysis and interpretation of data released by the Chinese Center for Disease Control. Zenodo. <https://doi.org/10.5281/zenodo.7754299>
- <sup>905</sup> *Id.*
- <sup>906</sup> Mallapaty S. (2023). COVID-origins study links raccoon dogs to Wuhan market: what scientists think. *Nature*, 10.1038/d41586-023-00827-2. Advance online publication. <https://doi.org/10.1038/d41586-023-00827-2>
- <sup>907</sup> WHO-China Report
- <sup>908</sup> Gao, G., Liu, W., Liu, P-P., Lei, W-W., Jia, Z., He, X., Liu, L-L., Shi, W., Tan, Y., Zou, S., Zhao, X., Wong, G., Wang, J., Wang, F., Wang, G., Qin, K., Gao, R-b., Zhang, J., Li, M., Wu, G. (Feb. 25, 2022). Surveillance of SARS-CoV-2 in the environment and animal samples of the Huanan Seafood Market. Research Square. <https://doi.org/10.21203/rs.3.rs-1370392/v1>
- <sup>909</sup> American College of Emergency Physicians. (2022). ACEP COVID-19 Field Guide. <https://www.acep.org/corona/covid-19-field-guide/home-safety/covid-19-aerosol-and-surface-stability/#:~:text=Recent%20findings%20have%20demonstrated%20that,and%2050%25%20relative%20humidity>).
- <sup>910</sup> Gao, G., Liu, W., Liu, P-P., Lei, W-W., Jia, Z., He, X., Liu, L-L., Shi, W., Tan, Y., Zou, S., Zhao, X., Wong, G., Wang, J., Wang, F., Wang, G., Qin, K., Gao, R-b., Zhang, J., Li, M., Wu, G. (Feb. 25, 2022). Surveillance of SARS-CoV-2 in the environment and animal samples of the Huanan Seafood Market. Research Square. <https://doi.org/10.21203/rs.3.rs-1370392/v1>

- <sup>911</sup> Discovery of a Rich Gene Pool of Bat SARS-Related Coronaviruses, *supra* note 184.
- <sup>912</sup> WHO-China Joint Report
- <sup>913</sup> Stoyan D, Chiu N-S.(2022). Statistics cannot prove that the Huanan Seafood Wholesale Market was the early epicenter of the COVID-19 pandemic. <https://arxiv.org/pdf/2208.10106.pdf>
- <sup>914</sup> WHO-China Report
- <sup>915</sup> *Id.*
- <sup>916</sup> Updated Assessment on COVID-19 Origins Key Takeaways. <https://www.dni.gov/files/ODNI/documents/assessments/Declassified-Assessment-on-COVID-19-Origins.pdf>
- <sup>917</sup> Wuhan Institute of Virology Organizes Centralized Study on the Educational Theme of ‘Staying True to our Original Aspiration, Keeping Firmly in Mind our Mission’,”
- <sup>918</sup> House Foreign Affairs Committee Report Minority Staff. (August 2021). The Origins of Covid-19: An Investigation of the Wuhan Institute of Virology. <https://gop-foreignaffairs.house.gov/wp-content/uploads/2021/08/ORIGINS-OF-COVID-19-REPORT.pdf>
- <sup>919</sup> *Id.*
- <sup>920</sup> A critical review, *supra* note 194
- <sup>921</sup> Van Noorden, R. (2013). Safety Survey Reveals Lab Risks. *Nature*. 493, 9–10. <https://doi.org/10.1038/493009a>
- <sup>922</sup> *Id.*
- <sup>923</sup> *Id.*
- <sup>924</sup> Rozo, M., Gronvall, G.K. (Aug. 18, 2015).The Reemergent 1977 H1N1 Strain and the Gain-of-Function Debate. *mBio*. 2015;6(4):e01013-15.. <https://doi.org/10.1128/mBio.01013-15> .
- <sup>925</sup> A critical review, *supra* note 194
- <sup>926</sup> Na, L., Hu, L., Jin, A., Li, J. Biosafety laboratory risk assessment. *Journal of Biosafety and Biosecurity*. 2019. 1; 90-92. <https://doi.org/10.1016/j.jobb.2019.01.011>
- <sup>927</sup> Campbell, M.J. Characterizing Accidents, Exposures, and Laboratory-acquired Infections Reported to the National Institutes of Health’s Office of Biotechnology Activities (NIH/OBA) Division Under the NIH Guidelines for Work with Recombinant DNA Materials from 1976–2010. *Applied Biosafety*. 2015. 201(1): 12-26. <https://www.liebertpub.com/doi/pdf/10.1177/153567601502000103>
- <sup>928</sup> Pike, R.M. (1979). Laboratory-Associated Infections: Incidence, Fatalities, Causes and Prevention. *Ann. Rev. Microbial*. 33:41-66.
- <sup>929</sup> Pike, R.M. (1976). Laboratory-acquired infections: summary and analysis of 3921 cases. *Health Lab Sci*. 13(2):105-114. <https://pubmed.ncbi.nlm.nih.gov/946794/>
- <sup>930</sup> Harding, L, Brandt-Byers, K. 2006. Epidemiology of laboratory-acquired infections. *Biological Safety: Principles and Practice* 4<sup>th</sup> edition. <https://doi.org/10.1128/9781555815899.ch4>
- <sup>931</sup> Martin JC. 1980. Behavior factors in laboratory safety: personnel characteristics and modifications of unsafe act. *Laboratory Safety: Theory and Practice*. Academic Press New York, NY.
- <sup>932</sup> Biosafety in Microbiological and Biomedical Laboratories manual page 4 2020 edition
- <sup>933</sup> *Id.*
- <sup>934</sup> Campbell, M.J. Characterizing Accidents, Exposures, and Laboratory-acquired Infections Reported to the National Institutes of Health’s Office of Biotechnology Activities (NIH/OBA) Division Under the NIH Guidelines for Work with Recombinant DNA Materials from 1976–2010. *Applied Biosafety*. 2015. 201(1): 12-26. <https://www.liebertpub.com/doi/pdf/10.1177/153567601502000103>
- <sup>935</sup> Sewell, D.L. Laboratory-acquired infections and biosafety. *Clin Microbiol Rev*. 1995;8(3):389-405. doi:10.1128/CMR.8.3.389 <https://www.ncbi.nlm.nih.gov/pmc/articles/PMC174631/pdf/080389.pdf>
- <sup>936</sup> *Id.*
- <sup>937</sup> Phillips, G.B. (1965). Causal Factors of Microbiological Laboratory Accidents. Miscellaneous Publications. US Army Biological Laboratories, Fort Detrick.
- <sup>938</sup> Sewell, D.L. Laboratory-acquired infections and biosafety. *Clin Microbiol Rev*. 1995;8(3):397 doi:10.1128/CMR.8.3.389 <https://www.ncbi.nlm.nih.gov/pmc/articles/PMC174631/pdf/080389.pdf>;
- Na, L., Hu, L., Jin, A., Li, J. Biosafety laboratory risk assessment. *Journal of Biosafety and Biosecurity*. 2019. 1; 90-92. <http://creativecommons.org/licenses/by-nc-nd/4.0/>
- <sup>939</sup> Harding, L., Byers, K. Epidemiology of laboratory-associated-infections. In: Fleming, D.O., Hunt, D.L., editors. *Biological safety: principles and practices*, 4th ed. Washington, DC: ASM Press; 2006. p. 53-77.
- <sup>940</sup> Pike, R. M. 1979. *Ann. Ref. Microbial*. 33:41-66.
- <sup>941</sup> <https://www.cdc.gov/labs/BMBL.html>

- <sup>942</sup> U.S. Centers for Diseases Control and Prevention. Biosafety in Microbiological and Biomedical Laboratories 6th Edition. (2020) <https://www.cdc.gov/labs/pdf/cdc-biosafetymicrobiologicalbiomedicallaboratories-2020-p.pdf>
- <sup>943</sup> Burnett, L.C., Lunn, G., Coico, R. Biosafety: guidelines for working with pathogenic and infectious microorganisms. *Curr Protoc Microbiol*. 2009 May;Chapter 1(1):Unit 1A.1. <https://doi.org/10.1002/9780471729259.mc01a01s1> . PMID: 19412909; PMCID: PMC7162325.
- <sup>944</sup> U.S. Centers for Diseases Control and Prevention. Biosafety in Microbiological and Biomedical Laboratories 6th Edition. (2020) <https://www.cdc.gov/labs/pdf/cdc-biosafetymicrobiologicalbiomedicallaboratories-2020-p.pdf>
- <sup>945</sup> *Id.*
- <sup>946</sup> Sewell DL. Laboratory-acquired infections and biosafety. *Clin Microbiol Rev*. 1995;8(3):389-405. doi:10.1128/CMR.8.3.389 <https://www.ncbi.nlm.nih.gov/pmc/articles/PMC174631/pdf/080389.pdf>
- <sup>947</sup> *Id.*
- <sup>948</sup> [https://www.phe.gov/s3/BioriskManagement/biosafety/Pages/Biosafety-Levels.aspx#:~:text=Activities%20and%20projects%20conducted%20in,\(maximum\)%20level%20of%20containment](https://www.phe.gov/s3/BioriskManagement/biosafety/Pages/Biosafety-Levels.aspx#:~:text=Activities%20and%20projects%20conducted%20in,(maximum)%20level%20of%20containment)
- <sup>949</sup> U.S. Centers for Diseases Control and Prevention. Biosafety in Microbiological and Biomedical Laboratories 6th Edition. (2020) <https://www.cdc.gov/labs/pdf/cdc-biosafetymicrobiologicalbiomedicallaboratories-2020-p.pdf>
- <sup>950</sup> *Id.*
- <sup>951</sup> *Id.*
- <sup>952</sup> *Id.*
- <sup>953</sup> *Id.*
- <sup>954</sup> *Id.*
- <sup>955</sup> Liu, Z., Zhuang, W., Hu, L., Rong, R., Li, J., Ding, W., & Li, N. (2020). Experimental and numerical study of potential infection risks from exposure to bioaerosols in one BSL-3 laboratory. *Building and environment*, 179, 106991. <https://doi.org/10.1016/j.buildenv.2020.106991>
- <sup>956</sup> Li, J., et al., “Biosafety Laboratory Risk Assessment,” *Journal of Biosafety and Biosecurity* (Volume 1, Issue 2), September 2019, available online 20 February 2019, p. 91. <https://doi.org/10.1016/j.jobb.2019.01.011>
- <sup>957</sup> *Id.*
- <sup>958</sup> National Academies of Science. (2012). Biosecurity Challenges of the Global Expansion of High-Containment Biological Laboratories: Workshop Summary. National Academies Press. <https://nap.nationalacademies.org/download/13315>
- <sup>959</sup> *Id.*
- <sup>960</sup> *Id.*
- <sup>961</sup> National Academies of Science. (2019). Developing Norms for the Provision of Biological Laboratories in Low-Resource Contexts: Proceedings of a Workshop. National Academies Press. <file:///C:/Users/Owner/Downloads/25311.pdf>
- <sup>962</sup> Lipsitch, M., & Inglesby, T. V. (2014). Moratorium on Research Intended To Create Novel Potential Pandemic Pathogens. *MBio*, 5(6). <https://doi.org/10.1128/mbio.02366-14> <https://www.ncbi.nlm.nih.gov/pmc/articles/PMC4271556/>
- <sup>963</sup> *Id.*
- <sup>964</sup> Fouchier, R. A. M. (2015). Studies on Influenza Virus Transmission between Ferrets: the Public Health Risks Revisited. *MBio*, 6(1). <https://doi.org/10.1128/mbio.02560-14>
- <sup>965</sup> *Id.*
- <sup>966</sup> *Id.*
- <sup>967</sup> *Id.*
- <sup>968</sup> Bienek, A., Heisz, M., & Su, M. (2017). Surveillance of laboratory exposures to human pathogens and toxins: Canada 2016. *Canada Communicable Disease Report*, 43(11), 228–235. <https://doi.org/10.14745/ccdr.v43i11a04>
- <sup>969</sup> *Id.*
- <sup>970</sup> National Academies of Science. (2019). Developing Norms for the Provision of Biological Laboratories in Low-Resource Contexts: Proceedings of a Workshop. National Academies Press. <file:///C:/Users/Owner/Downloads/25311.pdf>
- <sup>971</sup> Martin, JC. 1980. Behavior factors in laboratory safety: personnel characteristics and modifications of unsafe act. *Laboratory Safety: Theory and Practice*. Academic Press New York, NY.
- <sup>972</sup> Phillips GB. 1965. Causal factors in microbiological laboratory accidents and infections. Fort Detrick MD. AD 615-012. <https://apps.dtic.mil/sti/pdfs/AD0615012.pdf>

- <sup>973</sup> Viggiani, C. 2016. NIH Memorandum to Director, Office Biological and Chemical Safety, Washington University. <https://www.documentcloud.org/documents/23182227-hvistendahlthe-intercept-wustl-09-30-2016-chikungunya-lab-infection-report-to-nih-osp>
- <sup>974</sup> Hvistendahl M. 2022. Experimenting with disaster. *The Intercept*. <https://theintercept.com/2022/11/01/biosafety-lab-accident-chikungunya-virus/>
- <sup>975</sup> National Bio-and Agro-Defense Facility: Final Environmental Impact Statement. Technical report, US Department of Homeland Security, Washington, DC. 2008. Annex B.
- <sup>976</sup> Penzenstadler, A. Y. and N. (2015, May 29). 10 incidents discovered at the nation's biolabs. USA TODAY. <https://www.usatoday.com/story/news/2015/05/29/some-recent-us-lab-incidents/25258237/>
- <sup>977</sup> Corrigan-Curay J. 2010. NIH memorandum to administrator, Environmental Health and Safety, University of California, Irvine. <https://www.documentcloud.org/documents/23178914-hvistendahlthe-intercept-uc-irvine-05-07-2010-report-to-nih-osp>
- <sup>978</sup> Hvistendahl M. 2022. Experimenting with disaster. *The Intercept*. <https://theintercept.com/2022/11/01/biosafety-lab-accident-chikungunya-virus/>
- <sup>979</sup> *Id.*
- <sup>980</sup> US Right to Know Freedom of Information Act Email. <https://usrtk.org/wp-content/uploads/2021/08/OSU-LAI-SARS2-p2.pdf>
- <sup>981</sup> US Right to Know Freedom of Information Act Email. <https://usrtk.org/wp-content/uploads/2021/08/OSU-LAI-SARS2.pdf>
- <sup>982</sup> Wenting, X., & Yunyi, B. (n.d.). Source refutes Aussie journalist's rumor that researcher at Beijing lab infected with coronavirus at work - Global Times. [www.globaltimes.cn](http://www.globaltimes.cn). [https://www.globaltimes.cn/page/202108/1231030.shtml?fbclid=IwAR20ZTyFryNKIcJcRyTskovFqb4Wb48\\_osL0GnH-ixGiRFUst7BqHMHjY7c](https://www.globaltimes.cn/page/202108/1231030.shtml?fbclid=IwAR20ZTyFryNKIcJcRyTskovFqb4Wb48_osL0GnH-ixGiRFUst7BqHMHjY7c)
- <sup>983</sup> News, T. (2021, December 10). Scientist bitten by mouse in Taipei lab before testing positive for COVID | Taiwan News | 2021-12-10 01:36:00. Taiwan News. <https://www.taiwannews.com.tw/en/news/4371212>
- <sup>984</sup> News, T. (2021a, December 9). Scientist COVID positive after exposure in Taipei P3 lab | Taiwan News | 2021-12-09 22:34:00. Taiwan News. <https://www.taiwannews.com.tw/en/news/4371080>
- <sup>985</sup> Ellis, S., Chien, C-H., Matsuyama, (2021). *Taiwan investigates possible COVID lab leak as scientist tests positive after bites from infected mouse*. K. Bloomberg News: FORTUNE. [Taiwan: COVID lab leak after scientist bitten by infected mouse | Fortune](https://www.bloomberg.com/news/articles/2021-12-09-taiwan-investigates-possible-covid-lab-leak-after-scientist-tests-positive-after-bites-from-infected-mouse)
- <sup>986</sup> Taiwan Centers for Disease Control. (2021). The command center explained the progress of the investigation of the incident in the P3 laboratory of the Academia Sinica. [Translated]. [Command Center explains the progress of investigation of the P3 laboratory incident of the Chinese Academy of Sciences - Department of Disease Control of the Ministry of Health and Welfare \(cdc.gov.tw\)](https://www.cdc.gov.tw/en/pressroom/press-releases/20211209-command-center-explains-the-progress-of-investigation-of-the-p3-laboratory-incident-of-the-chinese-academy-of-sciences)
- <sup>987</sup> Xinhua News. Brucella cases caused by contaminated factory exhaust: report (2019). [http://www.xinhuanet.com/english/2019-12/27/c\\_138659939.htm](http://www.xinhuanet.com/english/2019-12/27/c_138659939.htm)
- <sup>988</sup> CNN, J. Y. and E. C. (2020, September 17). Bacterial outbreak infects thousands after factory leak in China. CNN. <https://www.cnn.com/2020/09/17/asia/china-brucellosis-outbreak-intl-hnk/index.html>
- <sup>989</sup> Pappas G. (2022). The Lanzhou Brucella Leak: The Largest Laboratory Accident in the History of Infectious Diseases?. *Clinical infectious diseases : an official publication of the Infectious Diseases Society of America*, 75(10), 1845–1847. <https://doi.org/10.1093/cid/ciac463>
- <sup>990</sup> Song, L., Gao, J., & Wu, Z. (2020). Laboratory-acquired infections with Brucella bacteria in China. *Biosafety and Health*, 3(2). <https://doi.org/10.1016/j.bsheal.2020.07.010>
- <sup>991</sup> Spratt B.G. (2007). Independent Review of the safety of UK facilities handling foot-and-mouth disease virus [ARCHIVED CONTENT] ([nationalarchives.gov.uk](http://nationalarchives.gov.uk))
- <sup>992</sup> Knight-Jones, T. J. D., & Rushton, J. (2013). The economic impacts of foot and mouth disease – What are they, how big are they and where do they occur? *Preventive Veterinary Medicine*, 112(3-4), 161–173. <https://doi.org/10.1016/j.prevetmed.2013.07.013>
- <sup>993</sup> Singapore man acquired SARS in government lab, panel says | CIDRAP (umn.edu).
- <sup>994</sup> U.S. Department of Homeland Security. (2008). NATIONAL BIO AND AGRO-DEFENSE FACILITY FINAL ENVIRONMENTAL IMPACT STATEMENT APPENDIX B A REVIEW OF BIOCONTAINMENT LAPSES AND LABORATORY-ACQUIRED INFECTIONS DECEMBER 2008 U.S. DEPARTMENT OF HOMELAND SECURITY. [https://www.dhs.gov/sites/default/files/publications/nbaf\\_feis\\_appendix\\_b\\_0.pdf](https://www.dhs.gov/sites/default/files/publications/nbaf_feis_appendix_b_0.pdf)
- <sup>995</sup> [Recent Singapore SARS case a laboratory accident \(nih.gov\)](https://www.nih.gov/news-events/stories/2022/11/01-recent-singapore-sars-case-a-laboratory-accident)



- <sup>996</sup> U.S. Department of Homeland Security. (2008). NATIONAL BIO AND AGRO-DEFENSE FACILITY FINAL ENVIRONMENTAL IMPACT STATEMENT APPENDIX B A REVIEW OF BIOCONTAINMENT LAPSES AND LABORATORY-ACQUIRED INFECTIONS DECEMBER 2008 U.S. DEPARTMENT OF HOMELAND SECURITY. [https://www.dhs.gov/sites/default/files/publications/nbaf\\_feis\\_appendix\\_b\\_0.pdf](https://www.dhs.gov/sites/default/files/publications/nbaf_feis_appendix_b_0.pdf)
- <sup>997</sup> *Id.*
- <sup>998</sup> Taiwan Sars man “feared shame.” (2003, December 19). News.bbc.co.uk. <http://news.bbc.co.uk/2/hi/asia-pacific/3333775.stm>
- <sup>999</sup> Palese, P., & Wang, T. T. (2011). Why Do Influenza Virus Subtypes Die Out? A Hypothesis. *MBio*, 2(5). <https://doi.org/10.1128/mbio.00150-11>
- <sup>1000</sup> Rozo, M., & Gronvall, G. K. (2015). The Reemergent 1977 H1N1 Strain and the Gain-of-Function Debate. *MBio*, 6(4). <https://doi.org/10.1128/mbio.01013-15>
- <sup>1001</sup> Kung, H. C., Jen, K. F., Yuan, W. C., Tien, S. F., & Chu, C. M. (1978). Influenza in China in 1977: recurrence of influenza virus A subtype H1N1. *Bulletin of the World Health Organization*, 56(6), 913–918. <https://pubmed.ncbi.nlm.nih.gov/310732/>
- <sup>1002</sup> Braburger, K., Hume, A. J., Muhlberger, E., & Olejnik, J. (2012). Forty-Five Years of Marburg Virus Research. *Viruses*, 4(10), 1878–1927. <https://doi.org/10.3390/v4101878>
- <sup>1003</sup> Risk of Exposure. (2020). <https://www.cdc.gov/vhf/marburg/exposure/index.html>
- <sup>1004</sup> CDC. (2019). Filoviridae. Centers for Disease Control and Prevention. <https://www.cdc.gov/vhf/virus-families/filoviridae.html>
- <sup>1005</sup> Zhou, D., Song, H., Wang, J., Li, Z., Ji, X., Hou, X., Xu, J. (2019). Biosafety and biosecurity. *Journal of Biosafety and Biosecurity*. 1: 15-18. <https://doi.org/10.1016/j.jobb.2019.01.001>
- <sup>1006</sup> *Id.*
- <sup>1007</sup> Hugging L, Xiaowei X, Hailie M, Zhiming Y. History of and suggestion for China’s biosafety legislation. *Journal of Biosafety and Biosecurity*. 2019. <https://doi.org/10.1016/j.jobb.2019.08.002>
- <sup>1008</sup> *Id.*
- <sup>1009</sup> Zhang Z, Wu J, Hao L, Yi Y, Qi J. Development of biosafety equipment for high-containment laboratory and for person protection in China. 2020. *Biosafety and Health*. 2:12-17. <http://dx.doi.org/10.1016/j.bsheat.2019.12.008>
- <sup>1010</sup> *Id.*
- <sup>1011</sup> Guangzhou Municipal Health Inspection Bureau. 2018. PowerPoint briefing on “common problems” encountered in biosafety inspections.
- <sup>1012</sup> Gao G. F. (2019). For a better world: Biosafety strategies to protect global health. *Biosafety and health*, 1(1), 1–3. <https://doi.org/10.1016/j.bsheat.2019.03.001>
- <sup>1013</sup> *Id.* Gao’s comments were also reported in “The Origins of Covid-19: An Investigation of the Wuhan Institute of Virology,” House Foreign Affairs Committee Report Minority Staff, August 2021, p. 18.
- <sup>1014</sup> Zhiming Y. Current status and future challenges of high-level biosafety laboratories in China. *Journal of Biosafety and Biosecurity*. 2019 Sept;1(2): 123-127. <https://doi.org/10.1016/j.jpbb.2019.09.005>
- <sup>1015</sup> *Id.*
- <sup>1016</sup> *Id.*
- <sup>1017</sup> *Id.*
- <sup>1018</sup> Wu G. Laboratory biosafety in China: past, present and future. *Journal of Biosafety and Health*. 2019. 1: 56-58. <http://dx.doi.org/10.1016/j.bsheat.2019.10.003>
- <sup>1019</sup> *Id.*
- <sup>1020</sup> 13<sup>th</sup> National People’s Congress Standing Committee. 13<sup>th</sup> National People’s Congress Standing Committee Legislative Plan. 2018. <https://zh.wikisource.org/user:NPCObserver/13thNPCSCLegislativePlan>
- <sup>1021</sup> *Id.*
- <sup>1022</sup> “Xi Jinping: Be on Guard against ‘Black Swan’ Incidents, Prevent ‘Grey Rhinos,’” (习近平：警惕“黑天鹅”防范“灰犀牛”), the People’s Daily (Online), 22 January 2019.
- <sup>1023</sup> On April 19, 2016, Xi gave a speech on controlling the Internet in which he spoke of the “frequent appearance of black swans” in the context of a changing era. See Shi Anbin (史安斌), “Xi Jinping ‘4/19 Speech’ Presents the ‘Chinese Plan’ for Global Internet Governance,” (习近平“4·19讲话”呈现互联网全球治理的“中国方案”), the People’s Daily Chinese Communist Party News (Online), 18 April 2017. On April 26, 2018, Xi gave a speech on energy and economic development in Wuhan in which he noted that mishandling black swan incidents and grey rhino incidents could have deleterious effects on China’s economy. “Xi Jinping: Speech at the Forum on Deeply

Promote Development of the Changjiang River Delta Economic Belt” (习近平：在深入推动长江经济带发展座谈会上的讲话), Seeking Truth (求是) reprinted in Xinhua (online), 31 August 2019.

<sup>1024</sup> Emphasis added. “Xi Jinping: Be on Guard against ‘Black Swan’ Incidents, Prevent ‘Grey Rhinos,’” (习近平：警惕“黑天鹅” 防范“灰犀牛”), the People’s Daily (Online), 22 January 2019.

<sup>1025</sup> “Wuhan Institute of Virology Convenes Study by the Party Committee’s Plenary Central Group and Special Investigation and Study Meeting of the Educational Theme ‘Never Forgetting our Original Aspiration and Keeping Firmly in Mind our Mission’ (武汉病毒所召开党委扩大中心组学习暨“不忘初心，牢记使命”主题教育专题调研会议), *Wuhan Institute of Virology* (Online), 30 July 2019.

<sup>1026</sup> Meixler E. Outrage in China over Latest Vaccine Safety Scandal. *Time Magazine* (Online), 23 July 2018.

<sup>1027</sup> Feng, J., & Li, Q. (2021). How to ensure vaccine safety: An evaluation of China's vaccine regulation system. *Vaccine*, 39(37), 5285–5294. <https://doi.org/10.1016/j.vaccine.2021.07.081>

<sup>1028</sup> Wang Chen (王晨), “To Provide a Legal Protection for the People’s Physical Health: Writing at the Time of the Passage of the People’s Republic of China Vaccine Administration Law” (为人民群众身体健康提供有力法制保障：写在中华人民共和国疫苗管理法通过之际), *The People’s Congress of China Magazine* (中国人大), No. 15, Vol. 483, 05 August 2019, pg.11.

<sup>1029</sup> See “Vaccine Administration Law of the People’s Republic of China,” *The National People’s Congress of the People’s Republic of China*. 29 June 2019.

<http://www.npc.gov.cn/englishnpc/c23934/202012/0b1fd779c29e49bd99eb0e65b66aa783.shtml>

<sup>1030</sup> The quoted text is “强调确保药品安全是各级党委和政府义不容辞之责，要始终把人民群众的身体健康放在首位... 完善我国疫苗管理体制，坚决守住安全底线，全力保障群众切身利益和社会安全稳定大局。” See Li Xiaokang (李小康), “To Pass a Good Law for the Country and Increase the Well-Being of the People: Highlights of Chairman Li Zhanshu Leading the National People’s Congress Investigation and Research Group to Hunan to Launch Legislative Research and Investigation” (为国家立良法为人民增福祉：栗战书委员长率全国人大调研组到湖南开展立法调研侧记), *The People’s Congress of China Magazine* (中国人大), No. 15, Vol. 483, 05 August 2019, pg.8.

<sup>1031</sup> World Health Organization Public Health Emergency of International Concern DRC Ebola Virus July 17 2019 <https://www.who.int/news/item/17-07-2019-ebola-outbreak-in-the-democratic-republic-of-the-congo-declared-a-public-health-emergency-of-international-concern>

<sup>1032</sup> Li Z. (July 11, 2019). Use the law to delimit the boundaries of the development of biotechnology, ensure and accelerate the healthy development of biotechnology. Xinhua reprinted on the official website of the PRC National People’s Congress (online).

<sup>1033</sup> *Id.*

<sup>1034</sup> “Explanation Regarding the Draft Biosecurity Law of the People’s Republic of China” (关于中华人民共和国生物安全法草案的说明), The National People’s Congress (Online), 19 October 2020.

<sup>1035</sup> “Explanation Regarding the Draft Biosecurity Law of the People’s Republic of China” (关于中华人民共和国生物安全法草案的说明), The National People’s Congress (Online), 19 October 2020.. The quote is “防范和禁止利用生物及生物技术侵害国家安全为重点。” For an English source, see Don Tse and Larry Ong, “Coronavirus Pushes CCP Factional Struggle to Inflection Point,” *SinoInsider* (Online), April 2020, p. 10.

<sup>1036</sup> Gao’s report references a “实验室生物泄漏。” See, “Explanation Regarding the Draft Biosecurity Law of the People’s Republic of China” (关于中华人民共和国生物安全法草案的说明), The National People’s Congress (Online), 19 October 2020.

<sup>1037</sup> “Explanation Regarding the Draft Biosecurity Law of the People’s Republic of China” (关于中华人民共和国生物安全法草案的说明), The National People’s Congress (Online), 19 October 2020. . The quoted text is “生物技术在带给人类进步和益处的同时，也带来生物安全问题和威胁。当前我国生物安全形势严峻，生物战和以非典、埃博拉病毒、非洲猪瘟等为代表的重大新发突发传染病及动植物疫情等传统生物威胁依然多发，生物恐怖袭击、生物技术误用谬用、实验室生物泄漏等非传统生物威胁凸显。”

<sup>1038</sup> “Explanation Regarding the Draft Biosecurity Law of the People’s Republic of China” (关于中华人民共和国生物安全法草案的说明), The National People’s Congress (Online), 19 October 2020. . The quoted text is “当前，我国在生物技术研发、基础设施建设上相对落后，在技术、产品和标准上存在较大差距，生物安全原创技术少，优秀成果少。”

- <sup>1039</sup> “Explanation Regarding the Draft Biosecurity Law of the People’s Republic of China” (关于中华人民共和国生物安全法草案的说明), The National People’s Congress (Online), 19 October 2020. . The quoted text is “将国家生物安全能力建设纳入法律，以法律形式将鼓励自主创新的产业政策和科技政策固定下来，牢牢掌握核心关键生物技术，依法保障和推进我国生物技术的发展，提升防范风险和威胁的能力。”
- <sup>1040</sup> Twenty-second meeting of the Standing Committee of the 13<sup>th</sup> National People’s Congress. (2020) Article 1. Biosafety Law of the Peoples Republic of China. <https://www.chinalawtranslate.com/en/biosecurity-law/>
- <sup>1041</sup> *Id.* Articles 45 & 46.
- <sup>1042</sup> *Id.* Article 49.  
<https://www.chinalawtranslate.com/en/biosecurity-law/>
- <sup>1043</sup> The Chinese is “中国科学院武汉病毒研究所.”
- <sup>1044</sup> Wuhan Institute of Virology, Chinese Academy of Sciences, About Us: [http://institute.wuhanvirology.org/About\\_Us2016/History2016/index.htm](http://institute.wuhanvirology.org/About_Us2016/History2016/index.htm) accessed September 1, 2022
- <sup>1045</sup> *Id.*
- <sup>1046</sup> *Id.*
- <sup>1047</sup> <https://usrtk.org/wp-content/uploads/2022/03/FL-2021-00033-March-2022-Production.pdf>
- <sup>1048</sup> BurrNIH-00000335-337
- <sup>1049</sup> NIAID EcoHealth Alliance R01 Grant, BurrNIH-00000335-337
- <sup>1050</sup> BurrNIH-00000335-337
- <sup>1051</sup> BurrNIH-00000335-337
- <sup>1052</sup> U.S. Department of State. (2018). China Opens First Bio Safety Level 4 Laboratory. US State Department Cable 190739Z Jan 18.
- <sup>1053</sup> *Id.*
- <sup>1054</sup> *Id.*
- <sup>1055</sup> *Id.*
- <sup>1056</sup> *Id.*
- <sup>1057</sup> *Id.*
- <sup>1058</sup> The quoted text is “P4 实验室建设对中国公共卫生至关重要。” See Zheng Qianli (郑千里) and Li Li (李莉), “Jiangxia Leads a New Literature, Riding a Crane while Playing a Carefree Tune: An Account of the Chinese Academy of Sciences Wuhan Institute of Virology P4 Laboratory Construction and Research Team” (江夏演新文乘鹤奏悠曲 – 记中科院武汉病毒研究所 P4 实验室建设和研究团队), *China Science Daily* (中国科学报) (Online), 08 January 2018.
- <sup>1059</sup> The second was built at the Harbin Veterinary Research Institute, which opened in 2018. Ryan Clarke and Lam Peng Er, “Coronavirus Research in China: Origins, International Networks, and Consequences,” Non-Traditional Security (NTS)-Asia Consortium, Nanyang Technological University Singapore, 20 May 2021, p. 12, 17-18.
- <sup>1060</sup> Cao Cong, et. al., p. 133, 138.
- <sup>1061</sup> Suttmeier RP, Cong C., Simon, DF. (2006). “China’s Innovation Challenge and the Remaking of the Chinese Academy of Sciences,” *Innovations Journal.*, MIT University Press: Cambridge, MA, p. 79-80.  
<https://scholarsbank.uoregon.edu/xmlui/handle/1794/4822>
- <sup>1062</sup> Kühner, H. “Between Autonomy and Planning: The Chinese Academy of Science in Transition,” *Minerva*, Vol. 22, No. 1, March 1984, p.13. <https://www.jstor.org/stable/41820552>
- <sup>1063</sup> Wilson, J. “Experts in Defense: How China’s Academicians Contribute to its Defense Science and Technology Development,” *SITC Research Briefs*, No. 10, University of California San Diego, 10 January 2015, p. 2.  
<https://escholarship.org/uc/item/19t4n2x8>
- <sup>1064</sup> Cong, C., Li, N., Li, X., Liu, L. “Reform of China’s Science and Technology System in the Xi Jinping Era,” *China: An International Journal*, Volume 16, Number 3, August 2018, [doi:10.1353/chn.2018.0028](https://doi.org/10.1353/chn.2018.0028), p. 137.  
<https://muse.jhu.edu/article/703443>
- <sup>1065</sup> Wilson, p. 2.
- <sup>1066</sup> Cao, C., Li, N., Li, X., & Liu, L. (2018). Reform of China’s Science and Technology System in the Xi Jinping Era. *China: An International Journal* 16(3), 120-141. [doi:10.1353/chn.2018.0028](https://doi.org/10.1353/chn.2018.0028), p. 137.  
<https://muse.jhu.edu/article/703443>
- <sup>1067</sup> The full, formal name of the WIV is the “Chinese Academy of Sciences Wuhan Institute of Virology” (中国科学院武汉病毒研究所).

<sup>1068</sup> Tai, M. C. *Fortifying China: The Struggle to Build a Modern Defense Economy*, Cornell Univ. Press: Ithaca, NY, 2009, p. 89.

<sup>1069</sup> In the words of two Chinese scholars: “China’s state-led system positions a top-down approach with the party-state as the key driver of S&TI development and emphasizes the central leadership and coordination.” See Yutao Sun and Cong Cao, “Planning for Science: China’s ‘Grand Experiment’ and Global Implications,” *Humanities and Social Sciences Communications Journal*, Vol. 8, Article Number: 215, 20 September 2021.

<sup>1070</sup> For an example of the lack of independence at the university level, see Anna Fifield, “In Xi Jinping’s China, a Top University can No Longer Promise Freedom of Thought,” *The Washington Post* (Online), 18 December 2019.

<sup>1071</sup> Kühner, H. “Between Autonomy and Planning: The Chinese Academy of Science in Transition,” *Minerva*, Vol. 22, No. 1, March 1984, p.13. <https://www.jstor.org/stable/41820552> p. 23.

<sup>1072</sup> “Threats to the U.S. Research Enterprise: China’s Talent Recruitment Plans,” Staff Report of the Permanent Subcommittee on Investigations of the U.S. Senate (Online), January 2020, p. 23-24.

<sup>1073</sup> See “State Council Organization Chart,” The State Council of the People’s Republic of China (Online), 28 August 2014.

<sup>1074</sup> Office of the Secretary of Defense, “2019 Annual Report to Congress: Military and Security Developments Involving the People’s Republic of China,” U.S. Department of Defense (Online), 02 May 2019, p. 97-98.

[https://media.defense.gov/2019/May/02/2002127082/-1/-1/2019\\_CHINA\\_MILITARY\\_POWER\\_REPORT.pdf](https://media.defense.gov/2019/May/02/2002127082/-1/-1/2019_CHINA_MILITARY_POWER_REPORT.pdf)

<sup>1075</sup> Tai, M.C. *Fortifying China: The Struggle to Build a Modern Defense Econom.* Cornell Univ. Press: Ithaca, NY, 2009, p. 205. <https://www.cornellpress.cornell.edu/book/9780801479212/fortifying-china/#bookTabs=1>

<sup>1076</sup> “The Chinese Academy of Sciences and the Academy of Military Sciences Sign Strategic Cooperation Framework Agreement” (中科院与军事科学院签署战略合作框架协议), Chinese Academy of Sciences (Online), 23 March 2018. [http://english.shanghaipasteur.cas.cn/IPIN2016/News2016/202008/t20200813\\_241676.html](http://english.shanghaipasteur.cas.cn/IPIN2016/News2016/202008/t20200813_241676.html)

<sup>1077</sup> The Office of the Spokesperson of the U.S. Department of State. (15 January 2021). “Fact Sheet: Activity at the Wuhan Institute of Virology,” *U.S. Department of State* (Online). <https://2017-2021.state.gov/fact-sheet-activity-at-the-wuhan-institute-of-virology/index.html>

<sup>1078</sup> Dou E. (22 June 2021). “Wuhan Lab’s Classified Work Complicates Search for Pandemic’s Origins,” *The Washington Post* (Online), <https://www.ihv.org/news/2021-Archives/The-Washington-Post-Wuhan-labs-classified-work-complicates-search-for-pandemics-origins.html>

<sup>1079</sup> For an example, see Xi Jinping’s 2018 speech to CAS and CAE researchers, particularly passages such as “广大工程科技工作者既要有工匠精神，又要有团结精神，围绕国家重大战略需求，瞄准经济建设和事关国家安全的重大工程科技问题，紧贴新时代社会民生现实需求和军民融合需求，加快自主创新成果转化应用，在前瞻性、战略性领域打好主动仗。” See “Xi Jinping: Speech to the Chinese Academy of Sciences’ 19th Plenary Meeting of Academicians and the Chinese Academy of Engineering’s 14th Plenary Meeting of Academicians” (习近平：在中国科学院第十九次院士大会、中国工程院第十四次院士大会上的讲话), Xinhua News Agency (Online), 28 May 2018.

<sup>1080</sup> There are numerous published studies of PLA-CAS research collaboration, including many cited throughout this report, but for a very recent example of an ongoing PLA-CAS partnership, see the December 2021 study on colonic inflammatory disorders conducted by a 12-person research group at the PLA AMMS led by Zhang Lingqiang, and a 7-person research group at the CAS Institute of Microbiology led by Liu Cuihua. Notice that the journal omits the AMMS affiliation from the description of the authors on Zhang’s team. Omissions occur frequently when authors from AMMS and other PLA institutions publish in English language scientific journals. Bo Wu, Lihua Qiang, Yong Zhang, et. al., “The Deubiquitinase OTUD1 Inhibits Colonic Inflammation by Suppressing RIPK1-Mediated NF-κB Signaling,” *Cellular & Molecular Immunology*, Volume 19, 07 December 2021, pg. 276-289.

<sup>1081</sup> For an example, see “Suzhou Institute of Nano-Tech and Nano-Bionics Holds Academic Conference and Ceremony to Appoint Gao Zhixian of the Chinese Academy of Military Medical Science a Visiting Researcher,” (苏州纳米所举行中国军事医学科学院高志贤客座研究员聘任仪式暨学术报告会), Nanjing Branch of the Chinese Academy of Sciences (Online), 17 December 2013.

<sup>1082</sup> For a reference to the PLA No. 306 Hospital undergoing joint training with the CAS Institute of Biophysics, see AMMS authors Li Xiang (李翔), Tan Bin (谈彬), Xu Chi (徐池), Xu Tianhao (徐天昊), and Mao Junwen (毛军文), “Thoughts on Promoting Deep Military-Civil Fusion Development in Biopharmaceutical Science and Technology” (推进生物医药科技军民融合深度发展的思考), *Chinese Journal of Medical Science Research Management* (中华医学科研管理杂志), Vol. 31, No. 4, 31 August 2018, p. 246.

- <sup>1083</sup> For an example involving experts in synthetic biology and precision medicine, see “Academy of Military Medical Science Institute of Bioengineering Researcher and Professor Ye Qinong Visits the Institute of Biomedical Engineering for Exchange” (军事医学科学院生物工程研究所研究员叶棋浓教授到医工所交流访问), Suzhou Institute of Biomedical Engineering and Technology Chinese Academy of Sciences (Online), 11 July 2016.
- <sup>1084</sup> Pollpeter, K., Allen, K.W. eds, (June 14, 2012). *The PLA as Organization v2.0*, Defense Technical Information Center (Online). p. 204. <https://apps.dtic.mil/sti/pdfs/AD1082742.pdf>
- <sup>1085</sup> Zhiming, Y. et. al, “Considerations about Improving the Planning of High-Level Biosafety Laboratory System in China,” (关于加强我国高等级生物安全实验室体系规划的思考), *Bulletin of the Chinese Academy of Sciences* (中国科学院院刊) (Online), 2016, 31(10): 12.
- <sup>1086</sup> Pollpeter, K. Allen, K.W. p. 204. For an example of PLA vaccine development, see Zhuang Yingna (庄颖娜), Chen Dong (陈冬), and Zhang Zhenwei (张振威), “Qin Chengfeng’s Research Group Develops Vaccine for Zika Virus Makes New Progress in Treating Encephaloma” (秦成锋团队研发寨卡病毒疫苗治疗脑瘤获新进展), *People’s Liberation Army Daily* (Online), 02 January 2019.
- <sup>1087</sup> Wan, Y., Shang, J., Sun, S., Tai, W., Chen, J., Geng, Q., He, L., Chen, Y., Wu, J., Shi, Z., Zhou, Y., Du, L., & Li, F. (2020). Molecular Mechanism for Antibody-Dependent Enhancement of Coronavirus Entry. *Journal of virology*, 94(5), e02015-19. <https://doi.org/10.1128/JVI.02015-19>
- <sup>1088</sup> Peng, K., Liu, W., et. al., (2019). “Calcium Channel Blockers Reduce Severe Fever with Thrombocytopenia Syndrome Virus (SFTSV) Related Fatality,” *Cell Research*, Volume 29: 739-753. <https://doi.org/10.1038/s41422-019-0214-z>
- <sup>1089</sup> *Id.* The researchers from the PLA AMMS Institute of Microbiology and Epidemiology were Li Hao, Zhang Shaofei, Dai Ke, Hu Yuanyuan, Wang Zhibo, Zhang Panhe, and Liu Wei. Two researchers from the PLA 154 Hospital, Cui Ning and Yuan Chun, also participated in the study as did Bai Jieying from the AMMS Laboratory Animal Center. It is worth noting that the WIV research group included Xiao Gengfu, the Secretary-General of the CCP Committee at the WIV.
- <sup>1090</sup> Xu, D., Li, F., et al. (2015). *The Unnatural Origin of SARS and New Species of Artificial Humanized Viruses as Genetic Weapons*. Beijing. Academy of Military Medical Sciences Press.
- <sup>1091</sup> N.B. Peter Daszak of the EcoHealth Alliance was a coauthor and the direct recipient of the U.S. government funding. Daszak worked with the WIV as a sub-grantee. See Zhou Peng, Fan Hang, Yang Xinglou, Et. al., “Fatal Swine Acute Diarrhea Syndrome Caused by an HKU2-related Coronavirus of Bat Origin,” *Nature*, Volume 556, 04 April 2018, pg. 255-258.
- <sup>1092</sup> See “Wuhan Institute of Virology’s Researcher Wang Hanzhong Wins First Class Award from the Chinese People’s Liberation Army for Medical Achievements” (武汉病毒所王汉中研究员获中国人民解放军医疗成果一等奖), Wuhan Institute of Virology (Online), 30 November 2015.
- <sup>1093</sup> The Office of the Spokesperson of the U.S. Department of State. (15 January 2021). “Fact Sheet: Activity at the Wuhan Institute of Virology,” *U.S. Department of State* (Online). <https://2017-2021.state.gov/fact-sheet-activity-at-the-wuhan-institute-of-virology/index.html>
- <sup>1094</sup> Markson, S., Gleeson, A. (11 May 2020). “The Covid Files: How the Red Army Oversaw Coronavirus Research,” *The Daily Telegraph* (Online). <https://www.dailytelegraph.com.au/coronavirus/the-covid-files-australianfunded-coronavirus-paper-used-in-chinese-military-facility/news-story/7241a6b112816f3951495e0fa52ed2aa>
- <sup>1095</sup> Markson, S. *What Really Happened in Wuhan*, Sydney, Australia: HarperCollins Publishers, September 2021, pgs. 279, 316.
- <sup>1096</sup> *Id.* pgs. 369-372.
- <sup>1097</sup> See “Scientists Make Major Breakthrough in a Design Element of Vaccine for Middle East Respiratory Syndrome” (科学家在中东呼吸综合征冠状病毒疫苗设计方面取得重大突破), Wuhan Institute of Virology (Online), 25 November 2016.
- <sup>1098</sup> Wan, Y., Shang, J., Sun S., Tai, W., Chen, J., Geng, Q., He, L., Chen, Y., Su, J., Shi, Z-L, Zhou, Y., Du, L., Li, F. (2019). Molecular mechanism for antibody-dependent enhancement of coronavirus entry. *Journal of Virology*. 94(5). <https://doi.org/10.1128/jvi.02015-19>
- <sup>1099</sup> Sun, X. (孙兴维) and Zhang Zhenwei (张振威), “Group of Military Experts Storm Deep into the Epidemic Area, Tent-Style Mobile Testing Labs Enter Operations” (军队专家组深入疫区攻关 帐篷式移动检测实验室投入运行), *People’s Liberation Army Daily* (Online), 31 January 2020.

- <sup>1100</sup>Chan, M., Zheng, W. (03 March 2020). “Meet the Major General on China’s Coronavirus Scientific Front Line,” *The South China Morning Post* (Online). <https://www.scmp.com/news/china/military/article/3064677/meet-major-general-chinas-coronavirus-scientific-front-line> .
- <sup>1101</sup>Markson, S. (2021). *What Really Happened in Wuhan*, Sydney, Australia: HarperCollins Publishers. pgs. 358, 364.
- <sup>1102</sup> The quoted text is “充分发挥武汉生物制品研究所，中科院 P4 生物安全实验室，国药集团武汉血液制品公司等核心机构的带动作用。” See “General Office of the Wuhan Municipal People’s Government Circular on the Release of the Wuhan Municipal Greater Health Industry Development Plan (2019-2035),” [市人民政府办公厅关于印发武汉市大健康产业发展规划 (2019-2035 年) 的通知], *Wuhan Municipal People’s Government* (Online), 08 April 2019, p. 19.
- <sup>1103</sup>Schuerberger, C., Abdulla, S., Puglisi, A. (2022). Mapping Biosafety-3 Laboratories by Publications. Center for Security and Emerging Technology. <https://cset.georgetown.edu/wp-content/uploads/CSET-Mapping-Biosafety-Level-3-Laboratories-by-Publications.pdf>
- <sup>1104</sup> Advertisement. (2019). Institute of Model Animal of Wuahn University. *Nature*. <https://www.nature.com/collections/heihdahdbe>
- <sup>1105</sup> Zhou, J., Wang, W., Zhong, Q., Hou, W., Yang, Z., Xiao, S. Y., Zhu, R., Tang, Z., Wang, Y., Xian, Q., Tang, H., & Wen, L. (2005). Immunogenicity, safety, and protective efficacy of an inactivated SARS-associated coronavirus vaccine in rhesus monkeys. *Vaccine*, 23(24), 3202–3209. <https://doi.org/10.1016/j.vaccine.2004.11.075>
- <sup>1106</sup> Gai, W., Zou, W., Lei, L., Luo, J., Tu, H., Zhang, Y., Wang, K., Tien, P., & Yan, H. (2008). Effects of different immunization protocols and adjuvant on antibody responses to inactivated SARS-CoV vaccine. *Viral immunology*, 21(1), 27–37. <https://doi.org/10.1089/vim.2007.0079>
- <sup>1107</sup> Luo, F., Liao, F. L., Wang, H., Tang, H. B., Yang, Z. Q., & Hou, W. (2018). Evaluation of Antibody-Dependent Enhancement of SARS-CoV Infection in Rhesus Macaques Immunized with an Inactivated SARS-CoV Vaccine. *Virologica Sinica*, 33(2), 201–204. <https://doi.org/10.1007/s12250-018-0009-2>
- <sup>1108</sup> The Institute of Model Animals of Wuhan University, China (2016) *European Heart Journal*, Volume 37, Issue 43. Pages 3257–3259, <https://doi.org/10.1093/eurheartj/ehw445>
- <sup>1109</sup> Butler, D. (2015). “Engineered Bat Virus Stirs Debate over Risky Research,” *Nature* <https://doi.org/10.1038/nature.2015.18787> .
- <sup>1110</sup> Cyranoski, D. (2017). “Inside the Chinese Lab Poised to Study the World’s Most Dangerous Pathogens,” *Nature* 542, pages 399–400 <https://doi.org/10.1038/nature.2017.21487> . For more detailed information on the history of lab leaks in China, see Chapter 7 of this report.
- <sup>1111</sup> See, “Keep Firmly in Mind Your Responsibilities, Hold Fast to the Mission, Be a Pioneer for our Nation in the Realm of High-Level Biosafety – The Achievements of the Zhengdian Lab Party Branch of the Chinese Academy of Sciences Wuhan Institute of Virology,” *Wuhan Institute of Virology* (Online), 12 November 2019.
- <sup>1112</sup> Huang, Y., Huang, J., Xia, H., Shi, Y., Ma, H., & Yuan, Z. (2019). Networking for training Level 3/4 biosafety laboratory staff. *Journal of biosafety and biosecurity*, 1(1), 46–49. <https://doi.org/10.1016/j.jobb.2018.12.004>
- <sup>1113</sup> Tai Ming Cheung, “Keeping Up with the *Jundui*: Reforming the Chinese Defense Acquisition, Technology and Industrial System,” in *Chairman Xi Remakes the PLA: Assessing Chinese Military Reforms*, ed. Phillip C. Saunders, et al., Washington, DC: National Defense University Press, 2019, p. 597.
- <sup>1114</sup>Zhang, Y. (2019). Wuhan P4 laboratory was smoothly accepted. *Journal of Biosafety and Biosecurity*. <https://www.readcube.com/articles/10.1016%2Fj.jobb.2018.12.010>
- <sup>1115</sup> World Health Organization (WHO) Consultative Meeting on High/Maximum Containment (Biosafety 4) Laboratories Networking. Meeting Report. 2017. 13-15 December. [https://who-whe-CPI-2018.40-eng%20\(1\).pdf](https://who-whe-CPI-2018.40-eng%20(1).pdf)
- <sup>1116</sup> About WIV----Wuhan Institute of Virology. [institute.wuhanvirology.org](http://institute.wuhanvirology.org). Accessed September 28, 2022. [http://institute.wuhanvirology.org/About\\_Us2016/Brief\\_Introduction2016/index.htm](http://institute.wuhanvirology.org/About_Us2016/Brief_Introduction2016/index.htm)
- <sup>1117</sup> Cyranoski, D. (2017). Inside the Chinese lab poised to study world’s most dangerous pathogens. *Nature* 542, 399–400. <https://doi.org/10.1038/nature.2017.21487>
- <sup>1118</sup> About WIV----Wuhan Institute of Virology. [institute.wuhanvirology.org](http://institute.wuhanvirology.org). Accessed September 28, 2022. [http://institute.wuhanvirology.org/About\\_Us2016/Brief\\_Introduction2016/index.htm](http://institute.wuhanvirology.org/About_Us2016/Brief_Introduction2016/index.htm)
- <sup>1119</sup> Virus: après le SRAS, la sulfureuse coopération France-Chine. *Challenges*. Published January 23, 2020. Accessed September 27, 2022. [https://www.challenges.fr/entreprise/sante-et-pharmacie/coronavirus-en-chine-apres-le-sras-la-sulfureuse-cooperation-franco-chinoise-a-wuhan\\_695165?fbclid=IwAR0RUis51AwaXfoqd8vZRKCI47CoikgcNATtblGzuMI7I-niWoAUTYJm9vM](https://www.challenges.fr/entreprise/sante-et-pharmacie/coronavirus-en-chine-apres-le-sras-la-sulfureuse-cooperation-franco-chinoise-a-wuhan_695165?fbclid=IwAR0RUis51AwaXfoqd8vZRKCI47CoikgcNATtblGzuMI7I-niWoAUTYJm9vM)

<sup>1120</sup> Zhang, S., Wu, J., Zhang, E., et al. “Research and development of airtight biosafety containment facility for stainless steel structures” *Journal of Biosafety and Biosecurity*. 1: 56-62. <https://doi.org/10.1016/j.jobbb.2019.01.010>

<sup>1121</sup> *Id.*

<sup>1122</sup> *Id.*

<sup>1123</sup> Cao, C., Li, N., Li, X., & Liu, L. (2018). Reform of China’s Science and Technology System in the Xi Jinping Era. *China: An International Journal* 16(3), 120-141. [doi:10.1353/chn.2018.0028](https://doi.org/10.1353/chn.2018.0028), p. 122.

<sup>1124</sup> The quoted text is “技术的‘卡脖子’问题是国外关键核心技术断供造成的直接结果。” See Xing Dongmei (邢冬梅), “The Causes of the Problem of ‘Stranglehold’ Technologies and [How to] Avoid Them” (‘卡脖子’技术问题的成因与规避), *National Governance (国家治理)* reprinted on the People’s Forum (Online), 23 December 2020.

<sup>1125</sup> The quote is taken from the introductory summary of an excellent translation of a PRC government text published in 2018 that outlines some of the specific technologies that PRC authorities categorize as “stranglehold technologies,” see “35 Key ‘Stranglehold’ Technologies,” from the PRC Ministry of Education as translated by the Georgetown University Center for Security and Emerging Technology (Online), 16 August 2021.

<sup>1126</sup> The quoted text is “针对产业薄弱环节，实施好关键核心技术攻关工程，尽快解决一批‘卡脖子’问题。” See “Xi Jinping Time: Enhance Innovative Capabilities to Solve the ‘Stranglehold’ Problem” (习近平时间提高创新能力解决“卡脖子”问题), *Xinhua News Agency (Online)*, 27 December 2020.

<sup>1127</sup> Cao, C., Li, N., Li, X., & Liu, L. (2018). Reform of China’s Science and Technology System in the Xi Jinping Era. *China: An International Journal* 16(3), 120-141. <https://doi.org/10.1353/chn.2018.0028>, p. 123.

<sup>1128</sup> *Id.* p. 126.

<sup>1129</sup> *Id.* p. 139. For discussion of longstanding tensions between CAS and the Ministry of Science and Technology, see Richard P. Suttmeier, Cong Cao, and Denis Fred Simon, “China’s Innovation Challenge and the Remaking of the Chinese Academy of Sciences,” *Innovations Journal*, Summer 2006, MIT University Press: Cambridge, MA, p. 90-91.

<sup>1130</sup> Xie, Y., Zhang, C., Lai, Q. (2014). China’s rise as a major contributor to science and technology. *Proceedings of the national Academies of Science*. 111: (26) 9437-9442. <https://doi.org/10.1073/pnas.140770911>

<sup>1131</sup> Cao, C., Li, N., Li, X., & Liu, L. (2018). Reform of China’s Science and Technology System in the Xi Jinping Era. *China: An International Journal* 16(3), 120-141. [doi:10.1353/chn.2018.0028](https://doi.org/10.1353/chn.2018.0028), p. 141.

<sup>1132</sup> The quoted text is “发现部分课题组和支撑部门在菌毒种保藏和实验活动方面有不规范之处，存在安全隐患。” See, “Wuhan Institute of Virology Launches Biosafety Inspection Work of Pathogen Microbiology Labs” (武汉病毒所开展病原微生物实验室生物安全检查工作), *Wuhan Institute of Virology (Online)*, 20 January 2011. Note: While this report was dated January 20, 2011, the webpage URL and the time stamp from Google search results indicate that the report was not posted on the WIV website until November 11, 2019, which is concurrent when the WIV was dealing with a major incident.

<sup>1133</sup> The WIV has two campuses. Its original campus, which is co-located with the Wuhan Branch of the Chinese Academy of Sciences, resides in the Xiao Hongshan Park in the central Wuhan district of Wuchang (武昌区). That facility contains BSL-2 and BSL-3 laboratories that have been in operation for many years. The WIV’s second campus is located in an outlying district of Wuhan called Jiangxia (江夏) in the Zhengdian Research Industrial Park (郑店科研园区). This newer campus houses the BSL-4 laboratory, China’s first facility built at the highest level of biocontainment. It also officially designated a “National Biosecurity Laboratory.” The Zhengdian Park campus also has BSL-2 and BSL-3 laboratories, which are located adjacent to the Wuhan Institute of Biological Products.

<sup>1134</sup> Josh Rogin, (2020). “State Department Cables Warned of Safety Issues at Wuhan Lab Studying Bat Coronaviruses,” *Washington Post*, April 14, 2020.

<sup>1135</sup> *Id.*

<sup>1136</sup> The quoted text is “综合安全检查中发现的问题提出有针对性的安全管理要求。” See, “Wuhan Institute of Virology Convenes 2019 Security Work Conference” (武汉病毒所召开 2019 年度安全工作会议), *Wuhan Institute of Virology (Online)*, 08 April 2019.

<sup>1137</sup> *Id.* The quoted text is “以近期全国各科研生产安全过程中的具体案例为警醒，要求进一步筑牢安全思想防线。”

<sup>1138</sup> “Wuhan Institute of Virology Party Committee Convenes Central Group Plenary Study Session” (武汉病毒所党委召开中心组（扩大）学习会议), *Wuhan Institute of Virology (Online)*, 12 September 2018; and “The Comprehensive Management General Party Branch of the Wuhan Institute of Virology Convenes Specialized Study

Meeting on ‘Staying True to our Original Aspiration, Keeping Firmly in Mind our Mission’” (武汉病毒所综合管理党总支召开“不忘初心，牢记使命”专题学习会), Wuhan Institute of Virology (Online), 20 September 2018.

<sup>1139</sup> The quoted text is “陈新文从中科院当前工作的短板和不足...” See “Wuhan Institute of Virology Party Committee Convenes Central Group Plenary Study Session” (武汉病毒所党委召开中心组（扩大）学习会议), *Wuhan Institute of Virology* (Online), 12 September 2018.

<sup>1140</sup> *Id.* The quoted text is “提出必须紧紧抓住事关国家全局和长远发展的关键领域和卡脖子问题。”

<sup>1141</sup> The quoted text is “他强调，研究所要在院党组的领导下，进一步明确未来一个时期发展思路何工作重点，推进生物安全大科学中心建设... 完善研究所保密管理体系建设工作... 进一步加强党建工作，认真抓好基层党组织建设，为研究所科技创新提供坚强的政治和组织保证。” See “Wuhan Institute of Virology Party Committee Convenes Central Group Plenary Study Session” (武汉病毒所党委召开中心组（扩大）学习会议), *Wuhan Institute of Virology* (Online), 12 September 2018.

<sup>1142</sup> *Id.* The quoted text is “当前我国科技发展形式逼人，挑战逼人，使命逼人，我们必须始终坚持需求导向，问题导向，目标导向的原则，面向国家需求，明确自己的科研定位，着力为解决短板和卡脖子问题，为实现中华民族伟大复兴，为国家，为人民做贡献。” Note that 中华民族伟大复兴 is often mistranslated as the “great rejuvenation of the Chinese nation,” when the word 民族 in this context is much closer to the meaning of “race” in English than to “nation,” as illustrated by Xiao’s reference to the “nation” (国家) and the “people” (人民) separately from the “race” (民族), which includes ethnic Chinese people worldwide regardless of legal nationality or national identity.

<sup>1143</sup> The quoted text is “聚焦国家当前紧迫需求和长远发展战略需求的重大科技任务，聚焦‘卡脖子’关键核心技术问题。” See, “Wuhan Branch Opens Fourth Quarter Party Building Work Advancement Meeting” (武汉分院召开第四季度党建工作推进会), Wuhan Branch of the Chinese Academy of Sciences (Online), 26 December 2018.

<sup>1144</sup> Robinson, D., Potter, R., Lammbrau, M., McWilliams, L. PCR (2022). Purchasing Report Wuhan China. Relectless Security 2.0. <https://internet2-0.com/wp-content/uploads/2022/08/PCR-Purchasing-Report-Wuhan-China.pdf>

<sup>1145</sup> “The Origins of Covid-19: An Investigation of the Wuhan Institute of Virology,” House Foreign Affairs Committee Report Minority Staff, August 2021, p. 19.

<sup>1146</sup> *Id.*

<sup>1147</sup> Wuhan Institute of Virology. (2019). Single source announcement for the procurement of positive pressure protective clothing project by Wuhan Institute of Virology, Chinese Academy of Sciences. [http://www.ccg.gov.cn/cggg/dfgg/dylygg/201903/t20190321\\_11790067.htm](http://www.ccg.gov.cn/cggg/dfgg/dylygg/201903/t20190321_11790067.htm)

<sup>1148</sup> *Id.* p. 17.

<sup>1149</sup> “Wuhan Institute of Virology Convenes 2019 Security Work Conference” (武汉病毒所召开 2019 年度安全工作会议), *Wuhan Institute of Virology* (Online), 08 April 2019.

<sup>1150</sup> *Id.* The quoted text is “他强调，要严格落实‘党政同责，一岗双责，齐抓共管，失职追责’的安全生产管理责任要求，坚持‘管业务必须管安全，管生产必须管安全’，必须使两方面工作齐头并进。”

<sup>1151</sup> *Id.* The quoted text is “要严格遵守国家，中科院和研究所各项安全管理法律，法规及规章制度，加强日常安全管理，不定期开展安全自查与隐患整改...”

<sup>1152</sup> *Id.* The quoted text is “研究所安全工作是研究所做好所有工作的前提和保障。”

<sup>1153</sup> *Id.* The quoted text is “她要求：一是要严格落实安全工作责任制，将安全管理工作与科研业务工作紧密结合，做到两者‘同计划，同部署，同检查，同总结，同评比’；二是实验室的各项操作必须严格遵照标准作业程序执行，不可存在任何侥幸心理；三是进一步加强学生安全管理。”

<sup>1154</sup> *Id.* The quoted text is “安全工作无小事，要时刻绷紧安全生产这根弦，做到规定动作不遗漏，发现问题及时整改到位。”

<sup>1155</sup> Party, E., Reiman, J. Gershey, E.L. (1996). CERTIFICATION OF BIOSAFETY LEVEL 3 (BSL3) FACILITIES. *Journal of the American Biological Safety Association*, 1(1) pp. 26-51. <https://www.liebertpub.com/doi/pdf/10.1177/109135059600100106#:~:text=BSL-3%20containment%20is%20predicated%20on,having%20the%20most%20negative%20pressure.>

<sup>1156</sup> Wuhan Institute of Virology Patent. Biological safety laboratory exhaust system. Google Patents. 2019.

<https://patent.google.com/patent/CN209960702U/en?assignee=WUhan+Institute+of+virology+of+CAS&sort=new&page=11>

<sup>1157</sup> *Id.*



- <sup>1158</sup> Wuhan Institute of Virology Patent. (2019). A kind of biosecurity laboratory exhaust system and negative pressure keeping method and circulation sterilization method. Google Patents. <https://patent.google.com/patent/CN110043999A/en?assignee=Wuhan+Institute+of+virology+of+CAS&sort=new&page=11>
- <sup>1159</sup> Wuhan Institute of Virology. 2019. Patent:No. 201910325059.0 Biosafety autoclave and sterilization method. <https://patents.google.com/patent/CN210078382U/en?assignee=Wuhan+Institute+of+Virology+of+CAS&sort=new&page=12>
- <sup>1160</sup> Clarke, R., Lam, P.E. (2021). “Coronavirus Research in China: Origins, International Networks, & Consequences,” Non-Traditional Security (NTS)-Asia Consortium, Nanyang Technological University Singapore. p. 14. <https://rsis-ntsasia.org/wp-content/uploads/2021/06/NTS-Asia-Monograph-Coronavirus-Research-in-China-May2021.pdf>
- <sup>1161</sup> Dou, E. (22 June 2021). “Wuhan Lab’s Classified Work Complicates Search for Pandemic’s Origins,” Washington Post (Online), <https://www.ihv.org/news/2021-Archives/The-Washington-Post-Wuhan-labs-classified-work-complicates-search-for-pandemics-origins.html>
- <sup>1162</sup> *Id.*
- <sup>1163</sup> See, “Wuhan Institute of Virology Holds 2019 Specialized Training on National Security” (武汉病毒所举办2019年国家专题培训), *Wuhan Institute of Virology* (Online), 13 May 2019.
- <sup>1164</sup> See, “Wuhan Institute of Virology Launches Educational Activities for 2019 New Students Matriculating to the Institute” (武汉病毒所开展2019级新生入所教育活动), *Wuhan Institute of Virology* (Online), 05 September 2019.
- <sup>1165</sup> Zhiming, Y. (2019). “Current Status and Future Challenges of High-Level Biosafety Laboratories in China,” *Journal of Biosafety and Biosecurity* (Online), Volume 1, Issue 2, September 2019. <https://www.sciencedirect.com/science/article/pii/S2588933819300391>
- <sup>1166</sup> *Id.*
- <sup>1167</sup> *Id.*
- <sup>1168</sup> *Id.*
- <sup>1169</sup> The quoted text is “实现了党建与业务工作的有机融合，做到了党建工作全覆盖，无死角。” See “Xiang Shuilun Examines the Wuhan Institute of Virology’s Work of Establishing a ‘Red Flag Party Branch’” (项水伦考核武汉病毒所“红旗党支部”创建工作), *Wuhan Institute of Virology* (Online), 11 June 2019.
- <sup>1170</sup> The quoted text is “针对进口关键核心设备可能出现的“卡脖子”问题，组织专业小组进行技术攻关及国产化代替产品的采购和研发...” See “Xiang Shuilun Examines the Wuhan Institute of Virology’s Work of Establishing a ‘Red Flag Party Branch’” (项水伦考核武汉病毒所“红旗党支部”创建工作), *Wuhan Institute of Virology* (Online), 11 June 2019.
- <sup>1171</sup> The quoted text is “武汉病毒所作为国家科研院所，其初心和使命就是‘创新科技，服务国家，福祉人民’，要通过这次主题教育自觉对标国家对科技创新工作提出的要求...” See “Wuhan Institute of Virology Convenes Promotion Meeting for Work on the Educational Theme of ‘Staying True to our Original Aspiration, Keeping Firmly in Mind our Mission’ and a Study Session of the Expanded Party Committee Central Group” (武汉病毒所召开“不忘初心，牢记使命”主题教育工作推进会暨党委中心组(扩大)学习会议), *Wuhan Institute of Virology* (Online), 21 June 2019.
- <sup>1172</sup> Emphasis added. The quoted text is “聚焦生物安全领域‘卡脖子’问题，提出解决方案，通过攻坚克难，切实推进生物安全大科学中心的建设与发展，助力国家科技发展。” See “Wuhan Institute of Virology Convenes Promotion Meeting for Work on the Educational Theme of ‘Staying True to our Original Aspiration, Keeping Firmly in Mind our Mission’ and a Study Session of the Expanded Party Committee Central Group” (武汉病毒所召开“不忘初心，牢记使命”主题教育工作推进会暨党委中心组(扩大)学习会议), *Wuhan Institute of Virology* (Online), 21 June 2019.
- <sup>1173</sup> “Wuhan Institute of Virology Convenes Centralized Study Session on the Educational Theme of ‘Staying True to our Original Aspiration, Keeping Firmly in Mind our Mission’” (武汉病毒所召开“不忘初心，牢记使命”主题教育集中学习班), *Wuhan Institute of Virology* (Online), 25 June 2019.
- <sup>1174</sup> The quoted text is “目前，生物安全大科学中心的筹建工作处于关键时期，这不仅需要广大管理人员不断提升眼界，素养和能力，做到担起责任，带好队伍，落实工作，还需要各部门之间充分协调，从而更好地为科技创新工作保驾护航。” “Wuhan Institute of Virology Convenes Centralized Study Session on the Educational

Theme of ‘Staying True to our Original Aspiration, Keeping Firmly in Mind our Mission’” (武汉病毒所召开‘不忘初心, 牢记使命’主题教育集中学习班), Wuhan Institute of Virology (Online), 25 June 2019.

<sup>1175</sup> The quoted text is “围绕‘卡脖子’的技术问题, 开展关键核心设备的管理交流与自主研发。” See “Wuhan Institute of Virology’s Zhengdian Laboratory Party Branch is Awarded with Honorary Title of ‘Red Flag Party Branch’ from Hubei Provincial Work Committee for Directly Subordinate Organizations” (武汉病毒所郑店实验室党支部荣获湖北省直机关工委“红旗党支部”荣誉称号), *Wuhan Institute of Virology* (Online), 01 July 2019.

<sup>1176</sup> “Wuhan Institute of Virology Organizes Centralized Study on the Educational Theme of ‘Staying True to our Original Aspiration, Keeping Firmly in Mind our Mission’,” (武汉病毒所组织“不忘初心, 牢记使命”主题教育集中学习), *Wuhan Institute of Virology* (Online), 09 July 2019. The quoted text from Xi is “习近平总书记强调我们既要善于补齐短板, 更要注重加固底板。” The second quote is “重点针对目前 P4 实验室在建设和运维过程中存在的短板和底板问题展开热烈讨论。”

<sup>1177</sup> Id. The quoted text is “党员领导班子成员通过深入调研和广泛征求意见, 充分了解和认识到限制研究所发展的短板和底板, 并提出有针对性和可操作性的解决措施。”

<sup>1178</sup> Id. The quoted text is “研究所生物安全大科学研究中心的建设, 不仅需要科研人员自身增强忧患意识, 时刻防控风险, 也需要科研支撑部门的管理人员在工作上进一步提质增效, 切实服务研究所的科技创新发展。”

<sup>1179</sup> The quoted text is “参会党员针对生物安全理论和技术培训, 安全隐患的筛查和管理制度的完善, 高精端仪器的共享及郑店实验室整体搬迁等方面提出了意见和建议。” “Party Branch of the Wuhan Institute of Virology Microbiological Resources and Bioinformatics Research Center Organizes Monthly Party Day Activities and Specialized Investigation and Study of ‘Staying True to our Original Aspiration, Keeping Firmly in Mind our Mission’” (武汉病毒所微生物资源与生物信息研究中心党支部组织“不忘初心, 牢记使命”主题党日暨主题教育专题调研会), *Wuhan Institute of Virology* (Online), 22 July 2019.

<sup>1180</sup> “Xi Jinping: Be on Guard against ‘Black Swan’ Incidents, Prevent ‘Grey Rhinos,’” (习近平: 警惕“黑天鹅”防范“灰犀牛”), *the People’s Daily* (Online), 22 January 2019.

<sup>1181</sup> “Wuhan Institute of Virology Convenes Study by the Party Committee’s Plenary Central Group and Special Investigation and Study Meeting of the Educational Theme ‘Never Forgetting our Original Aspiration and Keeping Firmly in Mind our Mission’” (武汉病毒所召开党委扩大中心组学习暨“不忘初心, 牢记使命”主题教育专题调研会议), *Wuhan Institute of Virology* (Online), 30 July 2019. For a general summary of the Xi speech, see Chris Buckley, “2019 is a Sensitive Year for China. Xi is Nervous,” *New York Times* (Online), 25 February 2019.

<sup>1182</sup> The quoted text is “肖庚富强调, 保证国家安全是头等大事。为维护政治, 经济, 社会等重点领域国家安全, 我们必须始终保持高度警惕, 既要警惕‘黑天鹅’事件, 也要防范‘灰犀牛’事件。” Note that the second half of the quote was borrowed verbatim from Xi’s speech. “Wuhan Institute of Virology Convenes Study by the Party Committee’s Plenary Central Group and Special Investigation and Study Meeting of the Educational Theme ‘Never Forgetting our Original Aspiration and Keeping Firmly in Mind our Mission’” (武汉病毒所召开党委扩大中心组学习暨“不忘初心, 牢记使命”主题教育专题调研会议), *Wuhan Institute of Virology* (Online), 30 July 2019.

<sup>1183</sup> Id. The quoted text is “我们要提高风险化解能力, 透过现象看本质, 力争把风险化解在源头, 防止各种风险传导, 叠加, 演变, 升级...”

<sup>1184</sup> Id. The quoted text is “他指出, P4 实验室的发展注重和合文化, 实验室内部要加强组织协调... 进一步增强所内员工的归属感, 使 P4 实验室在生物安全大科学中心的建设中发挥更大的作用。”

<sup>1185</sup> Id. Emphasis added. The quoted text is “她指出, 本次会议内容详实, 重点突出, 将提出的问题按轻重缓急的原则归类, 优先解决当前面临的急迫性问题, 并对下一步的工作进行部署和安排, 确保责任落实到位, 工作措施到位, 推动研究所稳步持续的发展。”

<sup>1186</sup> Id. Emphasis added. The quoted text is “他通过聚焦‘卡脖子’问题, 对标国家需求, 从实验室的设施硬件及技术层面, 生物安全管理, 与研究所的协同发展, 员工激励与奖励等方面, 深入剖析了 P4 实验室当前存在的主要问题及解决问题的主要思路。”

<sup>1187</sup> “The Origins of Covid-19: An Investigation of the Wuhan Institute of Virology,” House Foreign Affairs Committee Report Minority Staff, August 2021, p. 19-20. <https://foreignaffairs.house.gov/wp-content/uploads/2021/08/ORIGINS-OF-COVID-19-REPORT.pdf>

<sup>1188</sup> Wuhan Institute of Virology. A kind of continuous way high-level biosafety laboratory wastewater inactivating device and method. Google Patents. 2019.

<https://patents.google.com/patent/CN110040799A/en?assignee=Wuhan+Institute+of+Virology+of+CAS&sort=new&page=11>

<sup>1189</sup> *Id.*

<sup>1190</sup> Wuhan Institute of Virology. Descaling system of continuous biological safety laboratory wastewater treatment equipment. Google Patents. 2019.

<https://patents.google.com/patent/CN209940507U/en?assignee=Wuhan+Institute+of+Virology+of+CAS&sort=new&page=11>

<sup>1191</sup> The Committee Staff credits the House report for its discovery of the original Chinese source, but after examining that source, we note that the House report miscalculated the sum of the tender when it converted from Chinese RMB to U.S. dollars. The correct amount is roughly US\$1.3 million, not US\$132 million. “The Origins of Covid-19: An Investigation of the Wuhan Institute of Virology,” House Foreign Affairs Committee Report Minority Staff, August 2021, p. 19-20. <https://foreignaffairs.house.gov/wp-content/uploads/2021/08/ORIGINS-OF-COVID-19-REPORT.pdf>

<sup>1192</sup> Henneman, J.R., McQuade, E.A., Sullivan, R.R., Downard, J., Thackrah, A., Hislop, M. (2022). Analysis of range and use of a hybrid hydrogen peroxide system for biosafety 3 and animal biosafety level 3 agriculture laboratory decontamination. *Applied Biosafety*.. 27, 7-14. <https://doi.org/10.1089/apb.2021.0012>

<sup>1193</sup> Linsen, L., Van Landuyt, K., Ectors, N. Automated Sample Storage in Biobanking to Enhance Translational Research: The Bumpy Road to Implementation. *Front Med (Lausanne)*. 9;6:309. <https://doi.org/10.3389/fmed.2019.00309>

<sup>1194</sup> The quoted text is “找差距，抓落实，努力开创生物安全科技创新。” See “Wuhan Institute of Virology Convenes Situational Report Meeting for Educational Theme of ‘Staying True to our Original Aspiration, Firmly Keeping in Mind our Mission’ and Situational Report Meeting for Rectification” (武汉病毒所召开“不忘初心，牢记使命”主题教育工作情况通报会暨整改情况通报会), *Wuhan Institute of Virology* (Online), 28 August 2019.

<sup>1195</sup> *Id.* The quoted text is “针对影响研究所发展的关键问题及职工关注的热点问题。”

<sup>1196</sup> *Id.* The quoted text is “形成了由 5 个方面共计 20 个问题组成的检视问题清单。”

<sup>1197</sup> Xiao, G. (August 28, 2019). Wuhan Institute of Virology convenes situational report meeting for educational there of “staying true to our original aspiration, firmly keeping in mind our mission’ and situational report meeting on rectification.” *Wuhan Institute of Virology*. (online).

<sup>1198</sup> *Id.* The quoted text is “肖庚富在总结中强调，此次主题教育既是一次思想整治的洗礼，也是对研究所的一次‘全面体验.’ 通过对制约研究所发展关键问题的持续整改落实，我们坚信，武汉病毒所有信心，有能力，做好高等生物安全实验室建设，维护和管理工作。”

<sup>1199</sup> Le Duc J., Zhi-ming Y. (2019). “Safety and Security in the Age of Synthetic Biology,” *Journal of Biosafety and Biosecurity* (Online), 1 (2019), pg. 77-79. <https://www.sciencedirect.com/science/article/pii/S2588933819300330>

<sup>1200</sup> *Id.*

<sup>1201</sup> “Wuhan Municipal People’s Government General Office Notice Regarding the Issuance of the Implementation Plan for Reforming and Improving the Comprehensive Supervision System of the Medical and Health Industries in Wuhan” (市人民政府办公厅关于印发武汉市改革完善医疗卫生行业综合监管制度实施方案的通知), *Wuhan Municipal People’s Government* (Online), 21 April 2020.

<sup>1202</sup> *Id.* The document’s index number (K28044908/2020-810796) indicates that it was published in 2020, as does the date on the URL ([http://www.wuhan.gov.cn/zwgk/xxgk/zfwj/bgtwj/202004/t20200421\\_1039064.shtml](http://www.wuhan.gov.cn/zwgk/xxgk/zfwj/bgtwj/202004/t20200421_1039064.shtml)).

<sup>1203</sup> *Id.* The quoted text is “深化公共卫生服务监管。”

<sup>1204</sup> *Id.* The quoted text is “依法加强对… 传染病防治，实验室生物安全… 公共卫生服务的监管。”

<sup>1205</sup> *Id.* The quoted text is “加强对… 重大传染病规范报病、规范治疗和随访管理的监督检查。”

<sup>1206</sup> *Id.* The quoted text is “加强对公立医院公共卫生科能力建设和服务质量的考核，确保完成公共卫生服务、突发事件卫生应急处置、紧急医学救援等任务。”

<sup>1207</sup> “Central Committee No. 15 Patrol Inspection Group Opens Meeting on the Inspection of the Party Organization of the Chinese Academy of Sciences and its Mobilization Work” (中央第十五巡视组巡视中国科学院党组工作动员会召开), *China Science Daily* as reprinted on the Chinese Academy of Sciences (Online), 16 September 2019. “Central Committee No. 15 Patrol Inspection Group Gives Feedback on Inspection Situation to Chinese Academy of Sciences Party Organization” (中央第十五巡视组向中国科学院党组反馈巡视情况), CCP Central Commission on Discipline Inspection (Online), 10 January 2020.

<sup>1208</sup> *Id.* The quoted text is 重点是关于违反政治纪律、组织纪律、廉洁纪律、群众纪律、工作纪律和生活纪律等方面的举报和反映。

<sup>1209</sup> *Id.* The quoted text is 把“两个维护”作为根本任务 and 深入查找政治偏差。

<sup>1210</sup> “Central Committee No. 15 Patrol Inspection Group Gives Feedback on Inspection Situation to Chinese Academy of Sciences Party Organization” (中央第十五巡视组向中国科学院党组反馈巡视情况), CCP Central Commission on Discipline Inspection (Online), 10 January 2020.

<sup>1211</sup> *Id.* The quoted text is “巡视也发现一些问题，主要是：贯彻习近平总书记“三个面向”“四个率先”重要指示批示精神尚有差距，落实加强党的全面领导要求不够到位... 院士管理监督工作存在薄弱环节... 形式主义、官僚主义以及违反中央八项规定精神问题依然存在... 选人用人坚持政治标准不够...”

<sup>1212</sup> *Id.* The quoted text is “以实际行动践行‘两个维护’and “进一步做好院士增选和管理监督工作。”

<sup>1213</sup> See “Wuhan Institute of Virology Convenes Centralized Warning Education Plenary Meeting and Internal Audit Work Activation Meeting” (武汉病毒所召开集中警示教育大会暨内部审计工作启动会), Wuhan Institute of Virology (Online), 06 September 2019.

<sup>1214</sup> This data was found on the online Scientific Database Service Monitoring and Statistics System of Chinese Academy of Sciences, the WIV’s parent organization. This finding was first reported by the DRASTIC Research Group and the House Foreign Affairs Committee Minority Staff. HELP Committee staff have reviewed the original Chinese source and confirmed their finding. See “The Origins of Covid-19: An Investigation of the Wuhan Institute of Virology,” House Foreign Affairs Committee Report Minority Staff, August 2021, p. 20-22. DRASTIC Research Group, “An Investigation into the WIV Databases that were Taken Offline,” Research Gate (Online), February 2021, p. 2-3, 5-6.

<sup>1215</sup> The WIV called the database the Wildlife-Borne Viral Pathogen Database in its English publications, but a more precise translation would be the Wildlife-Borne Viral Pathogen Characteristic Database (野生动物携带病毒病原体特色数据库). The database was managed by coronavirus expert Shi Zhengli, Director of the WIV Research Center for Emerging Infectious Diseases and the CAS Key Laboratory of Special Pathogens, and Deputy Director of the Wuhan National Biosafety Laboratory (BSL-4). In addition, the original DRASTIC report cited above, the basic facts related to the removal of the database can also be found in the investigative report by Katherine Eban, “The Lab Leak Theory: Inside the Fight to Uncover COVID-19’s Origins,” Vanity Fair (Online), 03 June 2021.

<sup>1216</sup> The Editorial Board, “We’re still missing the origin story of this pandemic. China is sitting on the answers,” Washington Post (Online), 05 February 2021. <https://www.washingtonpost.com/opinions/2021/02/05/coronavirus-origins-mystery-china/>

<sup>1217</sup> Bostickson, B., Demaneuf G. DRASTIC Research Group (2021). “An Investigation into the WIV Databases that were Taken Offline,” Research Gate (Online), February 2021, p. 2-3, 5-6. <https://doi.org/10.13140/RG.2.2.28029.08160>

<sup>1218</sup> *Id.* p. 7.

<sup>1219</sup> *Id.* p. 5.

<sup>1220</sup> Tse, D., Ong L. (2020). “Coronavirus Pushes CCP Factional Struggle to Inflection Point,” *SinoInsider* (Online), p. 10. <https://sinoinsider.com/product/special-report-coronavirus-pushes-ccp-factional-struggle-to-inflection-point/>

<sup>1221</sup> The Editorial Board, (2021). “We’re still missing the origin story of this pandemic. China is sitting on the answers,” Washington Post (Online), 05 February 2021. <https://www.washingtonpost.com/opinions/2021/02/05/coronavirus-origins-mystery-china/>

<sup>1222</sup> Bostickson, B., Demaneuf G. DRASTIC Research Group (2021). “An Investigation into the WIV Databases that were Taken Offline,” Research Gate (Online), February 2021, p. 2-3, 5-6. <https://doi.org/10.13140/RG.2.2.28029.08160>

<sup>1223</sup> *Id.* Pg. 7.

<sup>1224</sup> “Competitive Consultation on Central Air Conditioning Renovation Project of Wuhan Institute of Virology, Chinese Academy of Sciences.” *China Government Procurement Network*, 16 Sept. 2019, <https://archive.is/bfoTD#selection-229.0-229.131>

<sup>1225</sup> Office of Research Facilities, Division of Technical Resources. BSL-3 and ABSL-3 HVAC system requirements-Part 1. National Institutes of Health. 2014. 01(51). <https://orf.od.nih.gov/technicalresources/documents/news%20to%20use%20pdf%20file>

<sup>1226</sup> Hanel E, Phillips GB, Gremillion GG. (1962). Technical Manuscript 1. Laboratory Design for Study of Infectious Disease. Office of the Safety Director US Army Chemical Corps Research and Development Command. Defense Technical Information Command Document #: 269-530. <https://apps.dtic.mil/sti/pdfs/AD0269530.pdf>

- <sup>1227</sup> Lackemeyer MG, de Kok-Mercado F, Wad J, Bollinger L, Kindrachuk J, Wahl-Jensen V, Kuhn J H, Jahrling P B. ABSL-4 Aerobiology biosafety and technology at the NIH/NIAID Integrated Research Facility at Fort Detrick. *Viruses*. 2014. 6; 137-150. <https://doi.org/10.3390/v6010137>
- <sup>1228</sup> Lackemeyer MG, de Kok-Mercado F, Wada J Bollinger L, Kindrachuk J, Wahl-Jensen V, Kuhn J H, Jahrling P B. ABSL-4 Aerobiology biosafety and technology at the NIH/NIAID Integrated Research Facility at Fort Detrick. *Viruses*. 2014. 6; 137-150. <https://doi.org/10.3390/v6010137>
- <sup>1229</sup> Ai Hongxia (艾红霞), “Testing Begins for Special Passage through Airport for Military World Games” (军运会航空口岸专用通道开通测试), Hebei Daily reprinted by Xinhua (Online), 26 September 2019.
- <sup>1230</sup> Id. The quoted text is “演练以实战形式，模拟了... 机场口岸通道发现 1 例新型冠状病毒感染的处置全过程，演练了从流行病学调查、医学排查、临时检疫区域设置、隔离留验、病例转送和卫生处理等多个环节。”
- <sup>1231</sup> “Multiple Places in China Strengthen Drills to Respond to Ebola Epidemic” (中国多地加强演练应对埃博拉疫情), Xinhua as reprinted on the People’s Daily (Online), 13 November 2014.
- <sup>1232</sup> U.S. Centers for Disease Control and Prevention (Online)(2019). “2014-2016 Ebola Outbreak in West Africa.”. <https://www.cdc.gov/vhf/ebola/history/2014-2016-outbreak/index.html#:~:text=The%20impact%20this%20epidemic%20had,outside%20of%20these%20three%20countries>.
- <sup>1233</sup> Staff searched public reports from 2007 to the present.
- <sup>1234</sup> Beijing focused on avian flu while Shanghai chose an unspecified infectious disease. “Capital Airport Holds Olympics Safety Emergency Drills” (首都机场举行奥运安全应急演练), CCTV as reprinted by sina.com (Online), 27 June 2008. “Shanghai World Expo Inspection and Quarantine Emergency Preparedness Drills and Tests” (上海世博会检验检疫应急预案演练侧记), PRC State Administration for Market Regulation’s website China Quality News (Online), 02 April 2010.
- <sup>1235</sup> Eban K. 2022. COVID-19 Origins: Investigating a “Complex and Grave Situation” Inside a Wuhan Lab. *Vanity Fair*. <https://www.vanityfair.com/news/2022/10/covid-origins-investigation-wuhan-lab>
- <sup>1236</sup> See, “Keep Firmly in Mind Your Responsibilities, Hold Fast to the Mission, Be a Pioneer for our Nation in the Realm of High-Level Biosafety – The Achievements of the Zhengdian Lab Party Branch of the Chinese Academy of Sciences Wuhan Institute of Virology, *Wuhan Institute of Virology* (Online), 12 November 2019.
- <sup>1237</sup> Party Committee of the Wuhan Institute of Virology. 2019. Keep in mind the responsibility and stick to the mission to be a pioneer in the field of high-level biosecurity in my country. Chinese Academy of Sciences’ journal *Kejuan Dangjian*. 2019 (4). <https://kydj.sciencenet.cn/content.aspx?id=3844>
- <sup>1238</sup> See “Keep Firmly in Mind Your Responsibilities, Hold Fast to the Mission, Be a Pioneer for our Nation in the Realm of High-Level Biosafety – The Achievements of the Zhengdian Lab Party Branch of the Chinese Academy of Sciences Wuhan Institute of Virology, *Wuhan Institute of Virology* (Online), 12 November 2019.
- <sup>1239</sup> Id.
- <sup>1240</sup> “Homepage of “Chutian Times””. [www.ctimes.cn](http://www.ctimes.cn). Archived from [the original](#) on 2011-04-01. Retrieved 2021-01-26.
- <sup>1241</sup> Li W., Zhen W.J. (November 15, 2019). “Explore the Institute of Model Animals of Wuahn University, which used to be one of the battlefields against SARS. Chutian Metropolis Daily. [Exploring the Institute of Model Animals of Wuhan University, which used to be one of the battlefields to fight against SARS – yqqlm \(new-qq-com.translate.google\)](#)
- <sup>1242</sup> Luo, F., Liao, F. L., Wang, H., Tang, H. B., Yang, Z. Q., & Hou, W. (2018). Evaluation of Antibody-Dependent Enhancement of SARS-CoV Infection in Rhesus Macaques Immunized with an Inactivated SARS-CoV Vaccine. *Virologica Sinica*, 33(2), 201–204. <https://doi.org/10.1007/s12250-018-0009-2>
- <sup>1243</sup> Partnership & Custom Media unit of Nature Research for Institute of Model Animal of Wuhan University. (2019). Advertisement Feature: Institute of Animal Models of Wuhan University. *Nature*. <https://www.nature.com/collections/heihdahdhe>
- <sup>1244</sup> [ann@ann95657173](#) Twitter (2021). <https://twitter.com/torontofarmen/status/1396961056212365316>
- <sup>1245</sup> Party Committee of the Wuhan Institute of Virology. 2019. Keep in mind the responsibility and stick to the mission to be a pioneer in the field of high-level biosecurity in my country. Chinese Academy of Sciences’ journal *Kejuan Dangjian*. 2019 (4). <https://kydj.sciencenet.cn/content.aspx?id=3844> The quoted text is “在实验室里，他们常常需要连续工作 4 个小时，甚至长达 6 小时，期间不能饮食，排泄，这对人的意志和体力是极大的考验。这不仅要求实验人员要具备熟练的操作技能，还要具备应对各种意外情况的能力。” Note that the word translated here as “unexpected” (意外) can also when used as a noun, refer to an “accident” or “mishap.”

<sup>1245</sup> Emphasis added. The quoted text is “由于 P4 实验室的研究对象是高致病性病原微生物, 在实验室里, 一旦打开了保存病毒的试管<sup>1245</sup> Id. The quoted text is “不要将工作任务看作压力, 每一个任务都是你不断提升自我的机遇和阶梯。我们这个团队的理念是吃亏是福...”

Evington K. 453 Taiwan contacts listed for COVID-19 positive lab worker.. Taiwan News December 14, 2021. <https://www.taiwannews.com.tw/en/news/4382701>

<sup>1245</sup> Id. Note the official's name in Chinese is 汲长征.

<sup>1246</sup> See “Wuhan Institute of Virology Launches Training on Safety Work” (武汉病毒所开展安全工作培训), *Wuhan Institute of Virology* (Online), 21 November 2019.

<sup>1247</sup> For more information on the pishi system, see Tsai W-H, Liu X. (2016) “Concentrating Power to Accomplish Big Things: The CCP’s Pishi System and Operation in Contemporary China,” *Journal of Contemporary China* (Online), 26(104), September 2016, p. 1-14

<https://www.tandfonline.com/doi/abs/10.1080/10670564.2016.1223109#:~:text=https%3A//doi.org/10.1080/10670564.2016.1223109>

<sup>1248</sup> Tsai-H. “A Unique Pattern of Policymaking in China’s Authoritarian Regime: The CCP’s Neican/Pishi Model,” *Asian Survey* (Online), Vol. 55, No. 6, University of California Press: November/December 2015, pp. 1093-1115. <https://online.ucpress.edu/as/article-abstract/55/6/1093/24827/A-Unique-Pattern-of-Policymaking-in-China-s?redirectedFrom=fulltext>

<sup>1249</sup> Gordon, M.R., Strobel, W.P., Hinshaw, D. “Intelligence on Sick Staff at Wuhan Lab Fuels Debate on Covid-19 Origin,” *Wall Street Journal* (Online), 23 May 2021. <https://www.wsj.com/articles/intelligence-on-sick-staff-at-wuhan-lab-fuels-debate-on-covid-19-origin-11621796228>

<sup>1249</sup> Sexton, J. “Josh Rogin: The Sick Researchers from

<sup>1250</sup> Id. Emphasis added. The quoted text is “培训会上, 武汉病毒所安保办副主任胡谦总结了过去一年安全检查过程中发现的若干共性问题, 指出安全隐患可能引发的严重后果, 强调隐患整改要彻底, 规范管理要保持。”

<sup>1251</sup> “The Wuhan Institute of Virology of the Chinese Academy of Sciences plans to use a single-source procurement method to publicize the procurement of air incineration devices and test service projects.” *China Government Procurement Network*, 3 Dec. 2019, <https://archive.is/Jifqr#selection-229.0-229.197>

<sup>1252</sup> “The Wuhan Institute of Virology of the Chinese Academy of Sciences plans to use a single-source procurement method to publicize the procurement of air incineration devices and test service projects.” *China Government Procurement Network*, 3 Dec. 2019, <https://archive.is/Jifqr#selection-229.0-229.197>

<sup>1253</sup> See, “Wuhan Institute of Virology Holds 2019 Training Class on Biosafety Laboratory Management and Techniques for Conducting Experiments” (武汉病毒所举办 2019 年生物安全实验室管理与实验技术培训班), *Wuhan Institute of Virology* (Online), 28 November 2019.

<sup>1254</sup> Id. The characters for Zhao’s name are 赵赤鸿.

<sup>1255</sup> Id. The quoted text is “课程内容涵盖了国家生物安全法律法规及标准, 高等级生物安全实验室管理体系, 实验室生物安全风险评估方法, 菌毒种保藏, 动物实验以及实验室废弃物处理等内容。”

<sup>1256</sup> Weiss, S.R. Forty years with coronaviruses. *Journal of Experimental Medicine*. 2020;217(5). doi:10.1084/jem.20200537

<sup>1257</sup> Hall, P. A., & Lemoine, N. R. (1991). Koch’s postulates revisited. *The Journal of pathology*, 164(4), 283–284. <https://doi.org/10.1002/path.1711640402>

<sup>1258</sup> Xu J. (2019). Reverse microbial etiology: A research field for predicting and preventing emerging infectious diseases caused by an unknown microorganism. *Journal of biosafety and biosecurity*, 1(1), 19–21. <https://doi.org/10.1016/j.jobb.2018.12.005>

<sup>1259</sup> Id.

<sup>1260</sup> Olival, K.J., Hosseini, P.R., Zambrana-Torrel, C., Ross, N., Bogich, T.L., Daszak, P. (2017). Host and viral traits predict zoonotic spillover from mammals. *Nature*. Jun 29;546(7660):646-650. <https://doi.org/10.1038/nature.22975>

<sup>1261</sup> Wang, L.F.; Cowled, C. (2015). *Bats and Viruses: A New Frontier of Emerging Infectious Diseases*. John Wiley Sons Inc.: Hoboken, NJ, USA.

<sup>1262</sup> Yang, X.L., Tan, C.W., Anderson, D.E., Jiang, R.D., Li, B., Zhang, W., Zhu, Y., Lim, X.F., Zhou, P., Liu, X.L., Guan, W., Zhang, L., Li, S.Y., Zhang, Y.Z., Wang, L.F., Shi, Z.L. (2019). Characterization of a filovirus (Měnglà virus) from Rousettus bats in China. *Nat Microbiol*. 4(3):390-395. <https://doi.org/10.1038/s41564-018-0328-y>

- <sup>1263</sup> Meet the scientist at the center of the covid lab leak controversy. MIT Technology Review. <https://www.technologyreview.com/2022/02/09/1044985/shi-zhengli-covid-lab-leak-wuhan/>
- <sup>1264</sup> The Editorial Board, “We’re still missing the origin story of this pandemic. China is sitting on the answers,” Washington Post (Online), 05 February 2021. DRASTIC Research Group, “An Investigation into the WIV Databases that were Taken Offline,” Research Gate (Online), February 2021.
- <sup>1265</sup> DRASTIC Research Group, “An Investigation into the WIV Databases that were Taken Offline,” Research Gate (Online), February 2021, p. 7.
- <sup>1266</sup> Guo, M., Yong, M., Liu, J., Huang, X., Li, X. Biosafety and data quality considerations for animal experiments with highly infectious agents at ABSL-3 facilities. *Journal of Biosafety and Biosecurity*. 2019. 1; 50-55. <http://creativecommons.org/licenses/by-nc-nd/4.0/>
- <sup>1267</sup> See <https://docs.google.com/document/d/15U2uE7Eru0QxRbf8QVRPRMpsCoYhGvT/edit>
- <sup>1268</sup> Cohen, J. Wuhan coronavirus hunter Shi Zhengli speaks out. *Science* 2020. <https://doi.org/10.1126/science.abd9835>
- <sup>1269</sup> Zeng, L-P. Reverse Genetic System of Bat SARS-like coronaviruses and function of ORFX. 2017. Wuhan Institute of Virology, Chinese Academy of Sciences. 2018. Available at <https://docs.google.com/document/d/1uZrBG5A720aLGtVI4kPp6nJM7FuuolwO/edit>
- <sup>1270</sup> Centers for Disease Control and Prevention. (2017). Laboratory Biosafety Guidelines for Handling and Processing Specimens Associated with SARS-CoV. <https://www.cdc.gov/sars/guidance/f-lab/app5.html>
- <sup>1271</sup> National Institutes of Health. (2019). NIH GUIDELINES FOR RESEARCH INVOLVING RECOMBINANT OR SYNTHETIC NUCLEIC ACID MOLECULES. [https://osp.od.nih.gov/wp-content/uploads/NIH\\_Guidelines.pdf](https://osp.od.nih.gov/wp-content/uploads/NIH_Guidelines.pdf)
- <sup>1272</sup> *Id.*
- <sup>1273</sup> Menachery, V., Yount, B., Debbink, K. *et al.* (2015) A SARS-like cluster of circulating bat corona viruses shows potential for human emergence. *Nat Med* 21, 1508–1513. <https://doi.org/10.1038/nm.3985>
- <sup>1274</sup> Zeng L-P. Reverse Genetic System of Bat SARS-like coronaviruses and function of ORFX. 2017. Wuhan Institute of Virology, Chinese Academy of Sciences. 2018. Available at <https://docs.google.com/document/d/1uZrBG5A720aLGtVI4kPp6nJM7FuuolwO/edit>
- <sup>1275</sup> *Id.*
- <sup>1276</sup> *Id.*
- <sup>1277</sup> Hu, B., Zeng, L.P., Yang, X.L., *et al.* Discovery of a rich gene pool of bat SARS-related coronaviruses provides new insights into the origin of SARS coronavirus. Drosten C, ed. *PLOS Pathogens*. 2017;13(11):e1006698. doi:10.1371/journal.ppat.1006698
- <sup>1278</sup> Wang, Q., Zhang, Y., Wu, L., *et al.* Structural and Functional Basis of SARS-CoV-2 Entry by Using Human ACE2. *Cell*. 2020;181(4). doi:10.1016/j.cell.2020.03.045
- <sup>1279</sup> Zeng, L-P. Reverse Genetic System of Bat SARS-like coronaviruses and function of ORFX. 2017. Wuhan Institute of Virology, Chinese Academy of Sciences. 2018. Available at <https://docs.google.com/document/d/1uZrBG5A720aLGtVI4kPp6nJM7FuuolwO/edit>
- <sup>1280</sup> Reply to Science Magazine. <https://www.science.org/pb-assets/PDF/News%20PDFs/Shi%20Zhengli%20Q&A-1630433861.pdf>
- <sup>1281</sup> Reply to *Science Magazine*. <https://www.science.org/pb-assets/PDF/News%20PDFs/Shi%20Zhengli%20Q&A-1630433861.pdf>
- <sup>1282</sup> Mention of humanized mice, bats and pangolins: Fact Sheet: Activity at the Wuhan Institute of Virology. United States Department of State. <https://2017-2021.state.gov/fact-sheet-activity-at-the-wuhan-institute-of-virology/index.html>
- <sup>1283</sup> Mention of transgenic mice and civets: Reply to Science Magazine. <https://www.science.org/pb-assets/PDF/News%20PDFs/Shi%20Zhengli%20Q&A-1630433861.pdf>
- <sup>1284</sup> See EcoHealth Alliance Grant Application signed November 5, 2019 (Tracking Number: Grant 12743073) pg 162.
- <sup>1285</sup> Menachery VD, Yount BL Jr, Debbink K, *et al.* A SARS-like cluster of circulating bat coronaviruses shows potential for human emergence [published correction appears in *Nat Med*. 2016 Apr;22(4):446] [published correction appears in *Nat Med*. 2020 Jul;26(7):1146]. *Nat Med*. 2015;21(12):1508-1513. <https://doi.org/10.1038/nm.3985>
- <sup>1286</sup> See Zeng, L.P., Gao, Y.T., Ge, X.Y., *et al.* Bat Severe Acute Respiratory Syndrome-Like Coronavirus WIV1 Encodes an Extra Accessory Protein, ORFX, Involved in Modulation of the Host Immune Response. *J Virol*. 2016;90(14):6573-6582. Published 2016 Jun 24. doi:10.1128/JVI.03079-15, “Recently, another bat SL-CoV strain,

SHC014, has been demonstrated to use human ACE2 by the construction of an infectious cDNA clone . Furthermore, animal infection experiments indicated that SL-CoV WIV1 and SHC014 could replicate efficiently and caused low pathogenesis in ACE2 transgenic mice. The fact that the native bat SL-CoVs could use human ACE2 without any mutations indicates a high risk of interspecies transmission for these and similar coronaviruses that may exist in natural reservoirs.”

<sup>1287</sup> BurNIH-00000385-286; BurNIH-00000484-491.

<sup>1288</sup> BurNIH-00000484-491.

<sup>1289</sup> BurNIH-00000485

<sup>1290</sup> BurNIH-00000491

<sup>1291</sup> BurNIH-00000483-495

<sup>1292</sup> BurNIH-00000483-495

<sup>1293</sup> BurNIH-00000491

<sup>1294</sup> Malaiyan, J., Arumugam, S., Mohan, K., & Gomathi Radhakrishnan, G. (2021). An update on the origin of SARS-CoV-2: Despite closest identity, bat (RaTG13) and pangolin derived coronaviruses varied in the critical binding site and O-linked glycan residues. *Journal of medical virology*, 93(1), 499–505.

<https://doi.org/10.1002/jmv.26261>

<sup>1295</sup> NIAID Grant EcoHealth Alliance Year-5 Progress Report

<sup>1296</sup> Carroll, D., Daszak, P., Wolfe, N.D., et al. The Global Virome Project. *Science*. 2018;359(6378):872-874. doi:10.1126/science.aap7463

<sup>1297</sup> <https://usrtk.org/wp-content/uploads/2021/05/GVP-State-Batch-3.pdf> (page 3)

<sup>1298</sup> Available at

<https://foia.state.gov/Search/Results.aspx?searchText=&beginDate=&endDate=&publishedBeginDate=20200716&publishedEndDate=20200716&caseNumber=>

<sup>1299</sup> Yong, E. Is It Possible to Predict the Next Pandemic? *The Atlantic*. Published October 25, 2017.

<https://www.theatlantic.com/science/archive/2017/10/pandemic-prediction-challenge/543954/>

<sup>1300</sup> Holmes, E.C., Rambaut, A., Andersen, K.G. Pandemics: spend on surveillance, not prediction. *Nature*.

2018;558(7709):180-182. doi:10.1038/d41586-018-05373-w

<sup>1301</sup> Piper, K. Can we stop the next pandemic by seeking out deadly viruses in the wild? *Vox*. Published May 7, 2022. Accessed September 27, 2022. <https://www.vox.com/future-perfect/2022/5/7/22973296/virus-hunting-discovery-deep-vzn-global-virome-project>

<sup>1302</sup> Carlson, C.J. From PREDICT to prevention, one pandemic later. *Lancet Microbe*. 2020 May;1(1):e6-e7. doi:10.1016/S2666-5247(20)30002-1. Epub 2020 Apr 1. PMID: 32835320; PMCID: PMC7148715.

<sup>1303</sup> USAID won't give details on \$4.67 million grant to Wuhan lab collaborator EcoHealth Alliance. *Washington Examiner*. Published February 8, 2022. Accessed September 27, 2022.

<https://www.washingtonexaminer.com/news/usaid-wont-give-details-on-4-67-million-grant-to-wuhan-lab-collaborator-ecohealth-alliance>

<sup>1304</sup> Menachery, V., Yount, B., Debbink, K. *et al.* A SARS-like cluster of circulating bat coronaviruses shows potential for human emergence. *Nat Med* 21, 1508–1513 (2015). <https://doi.org/10.1038/nm.3985>

<sup>1305</sup> <https://usrtk.org/wp-content/uploads/2022/01/China-GenBank-sequences.pdf>

<sup>1306</sup> <https://usrtk.org/wp-content/uploads/2022/01/China-GenBank-sequences.pdf>

<sup>1307</sup> <https://static1.squarespace.com/static/581a4a856b8f5bc98311fb03/t/60a594dd4444ce2a8b2d3599/162146428591/0/GVP+Fact+Sheet+2021.pdf>

<sup>1308</sup> Carroll, D., Daszak, P., Wolfe, N.D., et al. The Global Virome Project. *Science*. 2018;359(6378):872-874. doi:10.1126/science.aap7463

<sup>1309</sup> UC Davis PREDICT Emails

<sup>1310</sup> Zhou, H., Chen, X., Hu, T., et al. (2020). A novel bat coronavirus closely related to SARS-CoV-2 contains natural insertions at the S1/S2 cleavage site of the spike protein. *Current Biology*.

<https://doi.org/10.1016/j.cub.2020.05.023>

<sup>1311</sup> EcoHealth Alliance. (2018) Draft Defense Advanced Research Projects Agency proposal. Project DEFUSE: Defusing the threat of bat-borne coronaviruses. HR001118S0017-PREEMPT-PA 001

<https://www.documentcloud.org/documents/21066966-defuse-proposal>

<sup>1312</sup> *Id.*

<sup>1313</sup> Hu, B., Zeng, L. P., Yang, X. L., Ge, X. Y., Zhang, W., Li, B., Xie, J. Z., Shen, X. R., Zhang, Y. Z., Wang, N., Luo, D. S., Zheng, X. S., Wang, M. N., Daszak, P., Wang, L. F., Cui, J., & Shi, Z. L. (2017). Discovery of a rich



gene pool of bat SARS-related coronaviruses provides new insights into the origin of SARS coronavirus. *PLoS pathogens*, 13(11), e1006698. <https://doi.org/10.1371/journal.ppat.1006698>

<sup>1314</sup> EcoHealth Alliance. (2018) Draft Defense Advanced Research Projects Agency proposal. Project DEFUSE: Defusing the threat of bat-borne coronaviruses. HR001118S0017-PREEMPT-PA 001

<https://www.documentcloud.org/documents/21066966-defuse-proposal>

<sup>1315</sup> *Id.*

<sup>1316</sup> Becker GL, Lu Y, Hards K, Strehlow B, Levesque C, Lindberg I, Sandvig K, Bakowsky U, Day R, Garten W, Steinmetzer T. (2012). Highly potent inhibitors of proprotein convertase furin as potential drugs for treatment of infectious diseases. *Journal of Biochemistry*. 287(26): 21992-22003. <https://doi.org/10.11074/jbc.M111.332643>

<sup>1317</sup> Follis KE, York J, Nunberg JH. Furin cleavage of the SARS coronavirus spike glycoprotein enhances cell-cell fusion but does not affect virion entry. *Virology*. 2006. 350:358-369. <https://doi.org/10.1016/j.viol.2006.02.003>

<sup>1318</sup> Li, W., Wicht, O., van Kuppeveld, F. J., He, Q., Rottier, P. J., & Bosch, B. J. (2015). A Single Point Mutation Creating a Furin Cleavage Site in the Spike Protein Renders Porcine Epidemic Diarrhea Coronavirus Trypsin Independent for Cell Entry and Fusion. *Journal of virology*, 89(15), 8077–8081. <https://doi.org/10.1128/JVI.00356-15>

<sup>1319</sup> Cohen J. Wuhan coronavirus hunter Shi Zhengli speaks out. *Sciences* 2020.

<https://doi.org/10.1126/science.abd9835>.

<sup>1320</sup> Bao L, Deng W, Huang B, Gao H, Liu J, Ren L, Wei Q, Yu P, Xu Y, ...Peng X, Jin Q, Wu G, Qin C. (2020). The pathogenicity of SARS-CoV-2 in hACE2 transgenic mice. *Nature* 583, 830-833.

<https://doi.org/10.101038/s41586-020-2312-y>

<sup>1321</sup> Sun S-H, Chen Q, Gu H-J, Yang G, Wang Y-X, X-Y H, Liu S-S, Zhang N-N, Li X-F, Xiong R, Guo Y, Deng Y-Q, Huang W-J, Liu Q, Liu Q-M, Shen Y-L, Zhou Y, Yang X, Zhao T-Y, Fan C-F, Zhou Y-S, Qin C-F, Wang Y-C. (2020). A mouse model of SARS-CoV-2 infection and pathogenesis. *Cell Host and Microbe*. 28, 124-133.

<https://doi.org/10.1016/j.chom.2020.05.020>

<sup>1322</sup> Yang, X. H., Deng, W., Tong, Z., Liu, Y. X., Zhang, L. F., Zhu, H., Gao, H., Huang, L., Liu, Y. L., Ma, C. M., Xu, Y. F., Ding, M. X., Deng, H. K., & Qin, C. (2007). Mice transgenic for human angiotensin-converting enzyme 2 provide a model for SARS coronavirus infection. *Comparative medicine*, 57(5), 450–459.

<https://docserver.ingentaconnect.com/deliver/connect/aalas/15320820/v57n5/s3.pdf?expires=1677116494&id=0000&titleid=72010023&checksum=2AB36AD4DFB5F80C02D78067FCA1B295&host=https://www.ingentaconnect.com>

<sup>1323</sup> Jiang R-D, Liu M-Q, Chen Y, Shan C, Zhou Y-W, Shen X-R, Li Q, Zhang L, Zhu Y, Si H-R, Wang Q, Min J, Wan X, Zhang W, Li B, Zhang H-J, Baric RS, Zhou P, Yang X-L, Shi Z-L. (2020). Pathogenesis of SAR-CoV-2 in transgenic mice expressing human angiotensin-converting enzyme 2. *Cell*. 2020. 182,50-58.

<https://doi.org/10.1016/j.cell.2020.05.027>

<sup>1324</sup> Gu, H., Chen, Q., Yang, G., He, L., Fan, H., Deng, Y. Q., Wang, Y., Teng, Y., Zhao, Z., Cui, Y., Li, Y., Li, X. F., Li, J., Zhang, N. N., Yang, X., Chen, S., Guo, Y., Zhao, G., Wang, X., Luo, D. Y., ... Zhou, Y. (2020).

Adaptation of SARS-CoV-2 in BALB/c mice for testing vaccine efficacy. *Science (New York, N.Y.)*, 369(6511), 1603–1607. <https://doi.org/10.1126/science.abc4730>

<sup>1325</sup> Sun, S., He, L., Zhao, Z., Gu, H., Fang, X., Wang, T., Yang, X., Chen, S., Deng, Y., Li, J., Zhao, J., Li, L., Li, X., He, P., Li, G., Li, H., Zhao, Y., Gao, C., Lang, X., Wang, X., ... Sun, Y. (2021). Recombinant vaccine containing an RBD-Fc fusion induced protection against SARS-CoV-2 in nonhuman primates and mice. *Cellular & molecular immunology*, 18(4), 1070–1073. <https://doi.org/10.1038/s41423-021-00658-z>

<sup>1326</sup> Holmes, E. C., Goldstein, S. A., Rasmussen, A. L., Robertson, D. L., Crits-Christoph, A., Wertheim, J. O., Anthony, S. J., Barclay, W. S., Boni, M. F., Doherty, P. C., Farrar, J., Geoghegan, J. L., Jiang, X., Leibowitz, J. L., Neil, S. J. D., Skern, T., Weiss, S. R., Worobey, M., Andersen, K. G., Garry, R. F., ... Rambaut, A. (2021). The origins of SARS-CoV-2: A critical review. *Cell*, 184(19), 4848–4856. <https://doi.org/10.1016/j.cell.2021.08.017>

<sup>1327</sup> Qiu J.(2020) How China’s “Bat Woman” Hunted Down Viruses from SARS to the New Coronavirus. *Scientific American*. Published March 11, 2020. <https://www.scientificamerican.com/article/how-chinas-bat-woman-hunted-down-viruses-from-sars-to-the-new-coronavirus1/>

<sup>1328</sup> BurNIH-00000483-495.

<sup>1329</sup> Cohen, Jon. (2022). Looking for Trouble. *Science*. Published April 22, 2022.

<https://www.science.org/content/article/hunt-new-viruses-bat-trapping-scientist-hopes-prevent-future-pandemics>

<sup>1330</sup> Zhou, P., Yang, XL., Wang, XG. et al. A pneumonia outbreak associated with a new coronavirus of probable bat origin. *Nature* 579, 270–273 (2020). <https://doi.org/10.1038/s41586-020-2012-7>

<https://www.nature.com/articles/s41586-020-2012-7>

- <sup>1331</sup> Temmam, S., Vongphayloth, K., Baquero, E. *et al.* Bat coronaviruses related to SARS-CoV-2 and infectious for human cells. *Nature* **604**, 330–336 (2022). <https://doi.org/10.1038/s41586-022-04532-4>
- <sup>1332</sup> Qiu J. How China’s “Bat Woman” Hunted Down Viruses from SARS to the New Coronavirus. *Scientific American*. Published March 11, 2020. <https://www.scientificamerican.com/article/how-chinas-bat-woman-hunted-down-viruses-from-sars-to-the-new-coronavirus1/>
- <sup>1333</sup> Hu B, Zeng LP, Yang XL, et al. (2017). Discovery of a rich gene pool of bat SARS-related coronaviruses provides new insights into the origin of SARS coronavirus. Drosten C, ed. *PLOS Pathogens*. 2017;13(11):e1006698. <https://doi.org/10.1371/journal.ppat.1006698>
- <sup>1334</sup> Jacobsen R. (2021) Inside the risky bat-virus engineering that links America to Wuhan. *MIT Technology Review*. Published June 29, 2021. Accessed October 1, 2022. <https://www.technologyreview.com/2021/06/29/1027290/gain-of-function-risky-bat-virus-engineering-links-america-to-wuhan/>
- <sup>1335</sup> Menachery VD, Yount BL, Sims AC, et al. (2016). SARS-like WIV1-CoV poised for human emergence. *Proceedings of the National Academy of Sciences*. 2016;113(11):3048-3053. <https://doi.org/10.1073/pnas.1517719113> <https://www.pnas.org/doi/full/10.1073/pnas.1517719113>; *see also* Menachery VD, Yount BL, Debbink K, et al. (2015). A SARS-like cluster of circulating bat coronaviruses shows potential for human emergence. *Nature Medicine*. 2015;21(12):1508-1513. <https://doi.org/10.1038/nm.3985> <https://pubmed.ncbi.nlm.nih.gov/26552008/>
- <sup>1336</sup> Zeng LP, Gao YT, Ge XY, et al. (2016). Bat Severe Acute Respiratory Syndrome-Like Coronavirus WIV1 Encodes an Extra Accessory Protein, ORFX, Involved in Modulation of the Host Immune Response. *J Virol*. 90(14):6573-6582. Published 2016 Jun 24. <https://doi.org/10.1128/JVI.03079-15> <https://pubmed.ncbi.nlm.nih.gov/27170748/>
- <sup>1337</sup> Science Policy NIH GUIDELINES FOR RESEARCH INVOLVING RECOMBINANT OR SYNTHETIC NUCLEIC ACID MOLECULES (NIH GUIDELINES), National Institutes of Health Office, APRIL 2019. [https://osp.od.nih.gov/wp-content/uploads/NIH\\_Guidelines.pdf](https://osp.od.nih.gov/wp-content/uploads/NIH_Guidelines.pdf)
- <sup>1338</sup> Scobey T, Yount BL, Sims AC, et al. (2013). Reverse genetics with a full-length infectious cDNA of the Middle East respiratory syndrome coronavirus. *Proc Natl Acad Sci U S A*. 110(40):16157-16162. <https://doi.org/10.1073/pnas.1311542110>
- <sup>1339</sup> *See* Menachery VD, Yount BL, Debbink K, et al. A SARS-like cluster of circulating bat coronaviruses shows potential for human emergence. *Nature Medicine*. 2015;21(12):1508-1513. doi:10.1038/nm.3985 <https://www.nature.com/articles/nm.3985> where the researchers report, “On the basis of previous models of emergence [], the creation of chimeric viruses such as SHC014-MA15 was not expected to increase pathogenicity. Although SHC014-MA15 is attenuated relative to its parental mouse-adapted SARS-CoV, similar studies examining the pathogenicity of CoVs with the wild-type Urbani spike within the MA15 backbone showed no weight loss in mice and reduced viral replication. Thus, relative to the Urbani spike–MA15 CoV, SHC014-MA15 shows a gain in pathogenesis []. On the basis of these findings, scientific review panels may deem similar studies building chimeric viruses based on circulating strains too risky to pursue, as increased pathogenicity in mammalian models cannot be excluded. Coupled with restrictions on mouse-adapted strains and the development of monoclonal antibodies using escape mutants, research into CoV emergence and therapeutic efficacy may be severely limited moving forward. Together, these data and restrictions represent a crossroads of GOF research concerns; the potential to prepare for and mitigate future outbreaks must be weighed against the risk of creating more dangerous pathogens. In developing policies moving forward, it is important to consider the value of the data generated by these studies and whether these types of chimeric virus studies warrant further investigation versus the inherent risks involved.”
- <sup>1340</sup> *See* Menachery VD, Yount BL, Debbink K, et al. A SARS-like cluster of circulating bat coronaviruses shows potential for human emergence. *Nature Medicine*. 2015;21(12):1508-1513. doi:10.1038/nm.3985 <https://www.nature.com/articles/nm.3985> where the researchers opine, “Coupled with restrictions on mouse-adapted strains and the development of monoclonal antibodies using escape mutants, research into CoV emergence and therapeutic efficacy may be severely limited moving forward. Together, these data and restrictions represent a crossroads of GOF research concerns; the potential to prepare for and mitigate future outbreaks must be weighed against the risk of creating more dangerous pathogens. In developing policies moving forward, it is important to consider the value of the data generated by these studies and whether these types of chimeric virus studies warrant further investigation versus the inherent risks involved.”
- <sup>1341</sup> Lerner, S. L. H. H., Hvistendahl, M., Hibbett M. September 10 2021, M., & A.m, 1:03. (n.d.). NIH Documents Provide New Evidence U.S. Funded Gain-of-Function Research in Wuhan. *The Intercept*. <https://theintercept.com/2021/09/09/covid-origins-gain-of-function-research/>
- <sup>1342</sup> *Id.*

- <sup>1343</sup> *Id.*, “As a virologist, I personally think creating chimeras of SARS-related bat coronaviruses that are thought to pose high risk to humans entails unacceptable risks,” said Jesse Bloom, who studies the evolution of viruses at the Fred Hutchinson Cancer Research Center. Severe acute respiratory syndrome, or SARS, is a disease caused, like Covid-19, by an airborne coronavirus....” “One [scientist] said that the experiment ‘absolutely does not meet the bar’ for gain-of-function research. ‘You can’t predict that these viruses would be more pathogenic, or even pathogenic at all in people,’ said Angela Rasmussen, a virologist with the Vaccine and Infectious Disease Organization at the University of Saskatchewan. ‘They also did not study transmissibility at all in these experiments,’ meaning that the scientists did not look at whether the viruses could spread across a population.”
- <sup>1344</sup> EcoHealth Alliance. (2018). Project DEFUSE: Defusing the Threat of Bat-borne Coronaviruses. DARPA Grant Proposal HR 001118S0017. <https://www.documentcloud.org/documents/21066966-defuse-proposal>
- <sup>1345</sup> Huang Y, Yang C, Xu X, Xu W, Liu S. (2020). Structural and functional properties of SARS-CoV-2 spike protein: potential antiviral drug development for COVID-19. *Acta Pharmacologica Sinica*. 41(9):1141-1149. <https://doi.org/10.1038/s41401-020-0485-4> ; <https://www.nature.com/articles/s41401-020-0485-4>
- <sup>1346</sup> EcoHealth Alliance. (2018). Project DEFUSE: Defusing the Threat of Bat-borne Coronaviruses. DARPA Grant Proposal HR 001118S0017. <https://www.documentcloud.org/documents/21066966-defuse-proposal>
- <sup>1347</sup> *Id.*
- <sup>1348</sup> Lerner SLH, Hibbett September 23 2021 M, P.m 6:16. Leaked Grant Proposal Details High-Risk Coronavirus Research. The Intercept. <https://theintercept.com/2021/09/23/coronavirus-research-grant-darpa/>
- <sup>1349</sup> EcoHealth Alliance. Draft Defense Advanced Research Projects Agency proposal. Project DEFUSE: Defusing the threat of bat-borne coronaviruses. March 2018. HR001118S0017-PREEMPT-PA 001
- <sup>1350</sup> Zhou, P., Yang, XL., Wang, XG. *et al.* A pneumonia outbreak associated with a new coronavirus of probable bat origin. *Nature* **579**, 270–273 (2020). <https://doi.org/10.1038/s41586-020-2012-7>
- <sup>1351</sup> Ge, X. Y., Wang, N., Zhang, W., Hu, B., Li, B., Zhang, Y. Z., Zhou, J. H., Luo, C. M., Yang, X. L., Wu, L. J., Wang, B., Zhang, Y., Li, Z. X., & Shi, Z. L. (2016). Coexistence of multiple coronaviruses in several bat colonies in an abandoned mineshaft. *Virologica Sinica*, 31(1), 31–40. <https://doi.org/10.1007/s12250-016-3713-9>
- <sup>1352</sup> Trump “owes us an apology.” Chinese scientist at the center of COVID-19 origin theories speaks out. [www.science.org](http://www.science.org). Accessed October 14, 2022. <https://www.science.org/content/article/trump-owes-us-apology-chinese-scientist-center-covid-19-origin-theories-speaks-out>
- <sup>1353</sup> Zhou, P. , Yang, XL., Wang, XG. *et al.* (2020). A pneumonia outbreak associated with a new coronavirus of probable bat origin. *Nature* **579**, 270–273. <https://doi.org/10.1038/s41586-020-2012-7>
- <sup>1354</sup> Reply to Science Magazine. <https://www.science.org/pb-assets/PDF/News%20PDFs/Shi%20Zhengli%20Q&A-1630433861.pdf>
- <sup>1355</sup> Ge H, X. Y., Li, J. L., Yang, X. L., Chmura, A. A., Zhu, G., Epstein, J. H., Mazet, J. K., Hu, B., Zhang, W., Peng, C., Zhang, Y. J., Luo, C. M., Tan, B., Wang, N., Zhu, Y., Cramer, G., Zhang, S. Y., Wang, L. F., Daszak, P., & Shi, Z. L. (2013). Isolation and characterization of a bat SARS-like coronavirus that uses the ACE2 receptor. *Nature*, 503(7477), 535–538. <https://doi.org/10.1038/nature12711>
- <sup>1356</sup> Ge H, X. Y., Li, J. L., Yang, X. L., Chmura, A. A., Zhu, G., Epstein, J. H., Mazet, J. K., Hu, B., Zhang, W., Peng, C., Zhang, Y. J., Luo, C. M., Tan, B., Wang, N., Zhu, Y., Cramer, G., Zhang, S. Y., Wang, L. F., Daszak, P., & Shi, Z. L. (2013). Isolation and characterization of a bat SARS-like coronavirus that uses the ACE2 receptor. *Nature*, 503(7477), 535–538. <https://doi.org/10.1038/nature12711>
- <sup>1357</sup> NIAID Grant EcoHealth Alliance Year 4 Progress Report
- <sup>1358</sup> NIAID Grant EcoHealth Alliance Year 4 Progress Report
- <sup>1359</sup> NIAID Grant EcoHealth Alliance Year 4 Progress Report
- <sup>1360</sup> NIAID Grant EcoHealth Alliance Year 4 Progress Report p. 26.
- <sup>1361</sup> Guo, H., Li, A., Dong, T. Y., Su, J., Yao, Y. L., Zhu, Y., Shi, Z. L., & Letko, M. (2022). ACE2-Independent Bat Sarbecovirus Entry and Replication in Human and Bat Cells. *mBio*, 13(6), e0256622. <https://doi.org/10.1128/mbio.02566-22>
- <sup>1362</sup> Guo, H., Li, A., Dong, T. Y., Su, J., Yao, Y. L., Zhu, Y., Hu, B., Shi, Z. L., & Letko, M. (2023). Isolation of ACE2-dependent and -independent sarbecoviruses from Chinese 2 horseshoe bats. [bioRxiv 2023.03.02.530738](https://doi.org/10.1101/2023.03.02.530738); doi: <https://doi.org/10.1101/2023.03.02.530738>
- <sup>1363</sup> Temmam, S., Vongphayloth, K., Baquero, E. *et al.* (2022). Bat coronaviruses related to SARS-CoV-2 and infectious for human cells. *Nature* **604**, 330–336. <https://doi.org/10.1038/s41586-022-04532-4>
- <sup>1364</sup> *Id.*
- <sup>1365</sup> Zhou, H., Chen, X., Hu, T., Li, J., Song, H., Liu, Y., Wang, P., Liu, D., Yang, J., Holmes, E. C., Hughes, A. C., Bi, Y., & Shi, W. (2020). A Novel Bat Coronavirus Closely Related to SARS-CoV-2 Contains Natural Insertions at

the S1/S2 Cleavage Site of the Spike Protein. *Current biology : CB*, 30(11), 2196–2203.e3.

<https://doi.org/10.1016/j.cub.2020.05.023>

<sup>1366</sup> For general background on the process and time it takes to publish a peer-reviewed article, see Huisman J, Smits J. Duration and quality of the peer review process: the author’s perspective. *Scientometrics*. 2017;113(1):633–650. doi:10.1007/s11192-017-2310-5 <https://link.springer.com/article/10.1007/s11192-017-2310-5>

<sup>1367</sup> Kang D., Cheng M., McNeil S. (2020). China clamps down in hidden hunt for coronavirus origins. AP NEWS. Published December 30, 2020. <https://apnews.com/article/united-nations-coronavirus-pandemic-china-only-on-ap-bats-24fbadc58cee3a40bca2ddf7a14d2955>

<sup>1368</sup> *Id.* The notice is available at <https://www.documentcloud.org/documents/7340337-State-Research-regulations.html>

<sup>1369</sup> Frieman M. February 18, 2020 email to V. Menarchery concerning conversation with Ralph Baric indicating Shi Zhengli’s publication disclosing the existence of RaTG13 was not officially approved and may lead to her arrest. Source Freedom of Information Act

<sup>1370</sup> The Editorial Board, “We’re still missing the origin story of this pandemic. China is sitting on the answers,” *Washington Post* (Online), 05 February 2021. DRASTIC Research Group, “An Investigation into the WIV Databases that were Taken Offline,” *Research Gate* (Online), February 2021.

<sup>1371</sup> *Id.* see also Contributor, Anonymous & Bostickson, Billy & Demaneuf, Gilles. (2021). An investigation into the WIV databases that were taken offline. 10.13140/RG.2.2.28029.08160; see also Meet the scientist at the center of the covid lab leak controversy. *MIT Technology Review*.

<https://www.technologyreview.com/2022/02/09/1044985/shi-zhengli-covid-lab-leak-wuhan/>

<sup>1372</sup> Qui, J. (2022). Meet the scientist at the center of the covid lab leak controversy. *MIT Technology Review*.

<https://www.technologyreview.com/2022/02/09/1044985/shi-zhengli-covid-lab-leak-wuhan/>

<sup>1373</sup> Bostickson, B., Demaneuf, G. DRASTIC Research Group, “An Investigation into the WIV Databases that were Taken Offline,” *Research Gate* (Online), February 2021, p. 7.

<sup>1374</sup> Qui, J. Meet the scientist at the center of the covid lab leak controversy. *MIT Technology Review* 2022.

<https://www.technologyreview.com/2022/02/09/1044985/shi-zhengli-covid-lab-leak-wuhan/>

<sup>1375</sup> Lerner, S., Hvistendahl, P.M. (March 11 2022). Peter Daszak Answers Critics and Defends Coronavirus Research. *The Intercept*. Accessed October 14, 2022. <https://theintercept.com/2022/03/11/covid-nih-ecohealth-peter-daszak-interview/>

<sup>1376</sup> *Id.*

<sup>1377</sup> *Id.*

<sup>1378</sup> *EcoHealth Year 4 Report* 1R01AI110964, BurrNIH-00000293

<sup>1379</sup> *Id.*

<sup>1380</sup> Smiley Evans T, Shi Z, Boots M, et al. Synergistic China-US Ecological Research is Essential for Global Emerging Infectious Disease Preparedness. *EcoHealth*. 2020;17(1):160-173. doi:10.1007/s10393-020-01471-2 <https://www.ncbi.nlm.nih.gov/pmc/articles/PMC7088356/#CR15>

<sup>1381</sup> Zhou H, Chen X, Hu T, et al. (2020). A novel bat coronavirus closely related to SARS-CoV-2 contains natural insertions at the S1/S2 cleavage site of the spike protein. *Current Biology*. Published online May 2020. doi:10.1016/j.cub.2020.05.023

<sup>1382</sup> Yu P, Hu B, Shi ZL, Cui J. (2019). Geographical structure of bat SARS-related coronaviruses. *Infection, Genetics and Evolution*. 69:224-229. <https://doi.org/10.1016/j.meegid.2019.02.001>

<sup>1383</sup> U.S. Department of State. (2018). China Opens First Bio Safety Level 4 Laboratory. US State Department Cable 190739Z Jan 18.

<sup>1384</sup> For example, see Zhiming Y. (2019). “Current Status and Future Challenges of High-Level Biosafety Laboratories in China,” *Journal of Biosafety and Biosecurity* (Online), Volume 1, Issue 2, September 2019, p. 125

<sup>1385</sup> Wuhan Institute of Virology CAS. Biological safety laboratory exhaust system. CN Patent No. 209960702 U. 2020.01.17

<https://patentimages.storage.googleapis.com/0f/df/16/dc22588002d723/CN209960702U.pdf>

<https://patents.google.com/patent/CN209960702U/en>.

<sup>1386</sup> Wuhan Institute of Virology CAS. A kind of biosecurity laboratory exhaust system and negative pressure keeping method and circulation sterilization method. CN Patent No. 110043999A. 2019.07.23

<https://patentimages.storage.googleapis.com/5c/dd/9f/5516ac4f1a36af/CN110043999A.pdf>

<https://patents.google.com/patent/CN110043999A/en>

<sup>1387</sup> For example, see Communist Party Leaders Urge “Leapfrog Development” and Focus on “Stranglehold” Challenges: “Xiang Shuilun Examines the Wuhan Institute of Virology’s Work of Establishing a ‘Red Flag Party

Branch”, Wuhan Institute of Virology (Online), 11 June 2019 and WIV Leaders Discuss and Correct “Shortcomings” & “Foundational Problems”: “Wuhan Institute of Virology Organizes Centralized Study on the Educational Theme of ‘Staying True to our Original Aspiration, Keeping Firmly in Mind our Mission’”, Wuhan Institute of Virology (Online), 09 July 2019.

<sup>1388</sup> Rogin, J. (2021). In 2018, Diplomats Warned of Risky Coronavirus Experiments in a Wuhan Lab. No One Listened. Politico. <https://www.politico.com/news/magazine/2021/03/08/josh-rogin-chaos-under-heaven-wuhan-lab-book-excerpt-474322>

<sup>1389</sup> For example, see “Xiang Shuilun Examines the Wuhan Institute of Virology’s Work of Establishing a ‘Red Flag Party Branch’”, Wuhan Institute of Virology (Online), 11 June 2019.

<sup>1390</sup> See “Wuhan Institute of Virology Convenes Promotion Meeting for Work on the Educational Theme of ‘Staying True to our Original Aspiration, Keeping Firmly in Mind our Mission’ and a Study Session of the Expanded Party Committee Central Group”, *Wuhan Institute of Virology* (Online), 21 June 2019.

<sup>1391</sup> See “Wuhan Institute of Virology Convenes Promotion Meeting for Work on the Educational Theme of ‘Staying True to our Original Aspiration, Keeping Firmly in Mind our Mission’ and a Study Session of the Expanded Party Committee Central Group”, Wuhan Institute of Virology (Online), 21 June 2019.

<sup>1392</sup> See, “Keep Firmly in Mind Your Responsibilities, Hold Fast to the Mission, Be a Pioneer for our Nation in the Realm of High-Level Biosafety – The Achievements of the Zhengdian Lab Party Branch of the Chinese Academy of Sciences Wuhan Institute of Virology”, *Wuhan Institute of Virology* (Online), 12 November 2019.

<sup>1393</sup> Zhiming Y. (2019). Current status and future challenges of high-level biosafety laboratories in China. *Journal of biosafety and biosecurity*, 1(2), 123–127. <https://doi.org/10.1016/j.jobb.2019.09.005>

<sup>1394</sup> Announcement of competitive consultation on the maintenance project of P3 Laboratory and Laboratory Animal Center in Zhengdian Park, Wuhan Institute of Virology, Chinese Academy of Sciences. (2019). Chinese Procurement Network. [http://www.ccg.gov.cn/cggg/dfgg/jzxc/s/201903/t20190301\\_11699621.htm](http://www.ccg.gov.cn/cggg/dfgg/jzxc/s/201903/t20190301_11699621.htm)

<sup>1395</sup> Zhiming Y. (2019). Current status and future challenges of high-level biosafety laboratories in China. *Journal of biosafety and biosecurity*, 1(2), 123–127. <https://doi.org/10.1016/j.jobb.2019.09.005>

<sup>1396</sup> Wang L, Tong X, Xia X, Liu J, Wang Z, Zou J, Tang H, Du T, Yuan Z. Biosafety laboratory exhaust system. Wuhan Yuchen Patent Office. 2019.

<https://patents.google.com/patent/CN110083183A/en?assignee=Wuhan+Institute+of+Virology+of+CAS&sort=new&page=10>

<sup>1397</sup> The Committee Staff credits the House report for its discovery of the original Chinese source, but after examining that source, we note that the House report miscalculated the sum of the tender when it converted from Chinese RMB to U.S. dollars. The correct amount is roughly US\$1.3 million, not US\$132 million. “The Origins of Covid-19: An Investigation of the Wuhan Institute of Virology,” House Foreign Affairs Committee Report Minority Staff, August 2021, p. 19-20.

<sup>1398</sup> Henneman JR, McQuade EA, Sullivan RR, Downard J, Thackrah A, Hislop M. Analysis of range and use of a hybrid hydrogen peroxide system for biosafety 3 and animal biosafety level 3 agriculture laboratory; Zhang S, Wu, J, Zhang E, et al. (2019). “Research and development of airtight biosafety containment facility for stainless steel structures” 2019. *Journal of Biosafety and Biosecurity*. 1: 56-62. <https://doi.org/10.1016/j.jobb.2019.01.010>; Zhang H, Peng C, Liu B, Liu J, Zhiming Y, Shi, Z. (2018). Evaluation of MICRO-CHEM PLUS as a disinfectant for biosafety level 4 laboratory in China. *Applied Biosafety Journal of ABSA International*. 23(1): 32-38. <https://doi.org/10.1177/1535676018758891>

<sup>1399</sup> Tang H, Yao L, WU J, Li L, Liu J. (2019). Patent: A tourniquet-like instrument that is used in biological safety laboratory. CN1107555127A. November 15, 2019. <https://patents.google.com/patent/CN1107555127A/en?assignee=Wuhan+Institute+of+Virology+of+CAS&sort=new&page=8>

<sup>1400</sup> Harding L, Brandt-Byers K. (2006). Epidemiology of laboratory-acquired infections. *Biological Safety: Principles and Practice* 4<sup>th</sup> edition. <https://doi.org/10.1128/9781555815899.ch4>

<sup>1401</sup> Khan A., Gray A. (2011). Tourniquet uses and precautions. <https://tourniquets.org/wp-content/uploads/PDFs/Khan-Tourniquet-uses-and-precautions-2011.pdf>

<sup>1402</sup> “The Wuhan Institute of Virology of the Chinese Academy of Sciences plans to use a single-source procurement method to publicize the procurement of air incineration devices and test service projects.” China Government Procurement Network, 3 Dec. 2019, <https://archive.is/Jifqr#selection-229.0-229.197>

<sup>1403</sup> Gremillion GG, Mailler LF, Bodmer GA, (1958). An Electric Incinerator for Sterilization of Small Volumes of Air

- <sup>1404</sup> Hanel E, Phillips GB, Gremillion GG, (1962). Technical Manuscript 1. Laboratory Design for Study of Infectious Disease. Office of the Safety Director US Army Chemical Corps Research and Development Command. Defense Technical Information Command Document #: 269-530. Kuehne RW. Biological containment facility for studying infectious disease. *Appl Microbiol.* 1973;26(3):239-243. doi:10.1128/am.26.3.239-243.1973. <https://pubmed.ncbi.nlm.nih.gov/4751785/>
- <sup>1405</sup> Barbeito MS, Taylor LA, Seiders RW. (1968). Microbiological evaluation of a large-volume air incinerator. *Appl Microbiol.* 1968;16(3):490-495. doi:10.1128/am.16.3.490-495.1968. <https://pubmed.ncbi.nlm.nih.gov/4967758/>
- <sup>1406</sup> Kuehne RW. (1973). Biological containment facility for studying infectious disease. *Appl Microbiol.* 1973;26(3):239-243. <https://doi.org/10.1128/am.26.3.239-243> . <https://pubmed.ncbi.nlm.nih.gov/4751785/>
- <sup>1407</sup> The Wuhan Institute of Virology of the Chinese Academy of Sciences. (2019). "Plans to use a single-source procurement method to publicize the procurement of air incineration devices and test service projects." *China Government Procurement Network*, 3 Dec. 2019, <https://archive.is/Jifqr#selection-229.0-229.197>
- <sup>1408</sup> Wuhan Institute of Virology. (2019). Patent: No. 201910325059.0 Biosafety autoclave and sterilization method. <https://patents.google.com/patent/CN210078382U/en?assignee=Wuhan+Institute+of+Virology+of+CAS&sort=new&page=12>
- <sup>1409</sup> Wuhan Institute of Virology. (2019). Patent:No. 201910325059.0 Biosafety autoclave and sterilization method. <https://patents.google.com/patent/CN210078382U/en?assignee=Wuhan+Institute+of+Virology+of+CAS&sort=new&page=12>
- <sup>1410</sup> Centers for Disease Control and Prevention. (2016). Steam Disinfection. <https://www.cdc.gov/infectioncontrol/guidelines/disinfection/sterilization/steam.html#:~:text=Typical%20sterilization%20temperatures%20and%20times,for%20porous%20loads%20and%20instruments.&text=Like%20other%20sterilization%20systems%2C%20the,%2C%20chemical%2C%20and%20biological%20monitors>
- <sup>1411</sup> *Id.*
- <sup>1412</sup> *Id.*
- <sup>1413</sup> *Id.*
- <sup>1414</sup> *Id.*
- <sup>1415</sup> Centers for Disease Control Prevention & National institutes of Health. (2020). Biosafety in Microbiological and Biomedical Laboratories. 6<sup>th</sup> Edition. [https://www.cdc.gov/labs/pdf/SF\\_19\\_308133-A\\_BMBL6\\_00-BOOK-WEB-final-3.pdf](https://www.cdc.gov/labs/pdf/SF_19_308133-A_BMBL6_00-BOOK-WEB-final-3.pdf)
- <sup>1416</sup> Gao D, Zhang Q, Han K, Qian Q, Wenbo A.(2019). Google Patent: Integrated Biological Sensor CN 201922213832.2. December 11, 2019. <https://patents.google.com/patent/CN211375358U/en?assignee=Wuhan+Institute+of+Virology+of+CAS&sort=new&page=8>
- <sup>1417</sup> Guo, M., Wang, Y., Liu, J., Huang, Z., & Li, X. (2019). Biosafety and data quality considerations for animal experiments with highly infectious agents at ABSL-3 facilities. *Journal of biosafety and biosecurity*, 1(1), 50–55. <https://doi.org/10.1016/j.jobb.2018.12.011>
- <sup>1418</sup> *Id.*
- <sup>1419</sup> Carpenter C. B. (2018). Safety considerations for working with animal models involving human health hazards. *Animal models and experimental medicine*, 1(2), 91–99. <https://doi.org/10.1002/ame2.12019>
- <sup>1420</sup> Gao D, Zhang Q, Han K, Qian Q, Wenbo A. (2019). Google Patent: Integrated Biological Sensor CN 201922213832.2. December 11, 2019. <https://patents.google.com/patent/CN211375358U/en?assignee=Wuhan+Institute+of+Virology+of+CAS&sort=new&page=8>
- <sup>1421</sup> *Id.*
- <sup>1422</sup> *Id.*
- <sup>1423</sup> *Id.*
- <sup>1424</sup> Arthur J. (2009). Know the causes of stainless-steel corrosion in reports and take practical steps to prevent corrosion, 2019. Food Engineering. <https://www.foodengineeringmag.com/articles/98614-know-the-causes-of-stainless-steel-corrosion-in-reports-and-take-practical-steps-to-prevent-corrosion>; Mathiesen, Troels & Frantsen. Corrosion aspects for stainless steel surfaces in the brewery, dairy and pharmaceutical sectors. NACE - International Corrosion Conference Series. [https://www.researchgate.net/publication/242584517\\_Corrosion\\_aspects\\_for\\_stainless\\_steel\\_surfaces\\_in\\_the\\_brewery\\_dairy\\_and\\_pharmaceutical\\_sectors](https://www.researchgate.net/publication/242584517_Corrosion_aspects_for_stainless_steel_surfaces_in_the_brewery_dairy_and_pharmaceutical_sectors)

- <sup>1425</sup> Zhang S, Wu, J, Zhang E, et al. (2019). “Research and development of airtight biosafety containment facility for stainless steel structures”. *Journal of Biosafety and Biosecurity*. 1: 56–62. <https://doi.org/10.1016/j.jobb.2019.01.010>
- <sup>1426</sup> Zhang, H., Peng, C., Liu, B., Liu, J. Yuan, Z., Shi Z-L. (2018) Evaluation of MICRO-CHEM PLUS as a Disinfectant for Biosafety Level 4 Laboratory in China. *Applied Biosafety*. Mar 2018.32–38. <http://doi.org/10.1177/1535676018758891>
- <sup>1427</sup> National Chemical Laboratories Safety Data Sheet. May 2022. [https://www.nclonline.com/products/view/micro\\_chem\\_plus\\_#tab-safety](https://www.nclonline.com/products/view/micro_chem_plus_#tab-safety)
- <sup>1428</sup> Email communication US Senate HELP Committee with Technical Representative National Chemical Laboratories May 11 2022.
- <sup>1429</sup> Jia W, Zhiming Y, Hao T, Jun L, Hao Q, Yi L, Lin W. (2020).Google Patents. Object surface disinfectant for high-grade biosafety laboratory and preparation method thereof. <https://patents.google.com/patent/CN112262846B/en?assignee=Wuhan+Institute+of+Virology+of+CAS&sort=new&page=5>
- <sup>1430</sup> Hakki, S., Zhou, J., Jonnerby, J., Singanayagam, A., Barnett, J. L., Madon, K. J., Koycheva, A., Kelly, C., Houston, H., Nevin, S., Fenn, J., Kundu, R., Crone, M. A., Pillay, T. D., Ahmad, S., Derqui-Fernandez, N., Conibear, E., Freemont, P. S., Taylor, G. P., Ferguson, N., ... ATACCC study investigators (2022). Onset and window of SARS-CoV-2 infectiousness and temporal correlation with symptom onset: a prospective, longitudinal, community cohort study. *The Lancet. Respiratory medicine*, 10(11), 1061–1073. [https://doi.org/10.1016/S2213-2600\(22\)00226-0](https://doi.org/10.1016/S2213-2600(22)00226-0)
- <sup>1431</sup> Qiu, X., Nergiz, A. I., Maraolo, A. E., Bogoch, I. I., Low, N., & Cevik, M. (2021). The role of asymptomatic and pre-symptomatic infection in SARS-CoV-2 transmission—a living systematic review. *Clinical microbiology and infection : the official publication of the European Society of Clinical Microbiology and Infectious Diseases*, 27(4), 511–519. <https://doi.org/10.1016/j.cmi.2021.01.011>
- <sup>1432</sup> Johansson, M.A., Quandelacy, T.M., Kada, S., et al. (2021). SARS-CoV-2 Transmission From People Without COVID-19 Symptoms. *JAMA Netw Open*. 4(1):e2035057. <https://doi.org/10.1001/jamanetworkopen.2020.35057>
- <sup>1433</sup> Cascella, M., Rajnik, M., Aleem, A., et al. (2022). Features, Evaluation, and Treatment of Coronavirus (COVID-19). In: StatPearls [Internet]. Treasure Island (FL): StatPearls Publishing. <https://www.ncbi.nlm.nih.gov/books/NBK554776/>
- <sup>1434</sup> Singer, M., & Berg, P. (1976). Recombinant DNA: NIH Guidelines. *Science (New York, N.Y.)*, 193(4249), 186–188. <https://doi.org/10.1126/science.11643320>
- <sup>1435</sup> Menachery, V., Yount, B., Debbink, K. et al. A SARS-like cluster of circulating bat coronaviruses shows potential for human emergence. *Nat Med* 21, 1508–1513 (2015). <https://doi.org/10.1038/nm.398>
- <sup>1436</sup> U.S. Department of State. (2018). China Opens First Bio Safety Level 4 Laboratory. US State Department Cable 190739Z Jan 18.
- <sup>1437</sup> *Id.*
- <sup>1438</sup> Zhengli S., Cohen J. (2020). Wuhan coronavirus hunter Shi Zhengli speaks out. *Science*. 2020;369(6503):487–488. doi:10.1126/science.369.6503.487 (written responses). <https://www.science.org/pb-assets/PDF/News%20PDFs/Shi%20Zhengli%20Q&A-1630433861.pdf>
- <sup>1439</sup> BurrNIH-00000483-495.
- <sup>1440</sup> B.L.S A. COVID-19: US NIH Partially Terminates Grant to EcoHealth Alliance – The Wire Science. Accessed October 10, 2022. <https://science.thewire.in/the-sciences/us-national-institute-of-health-terminates-grant-to-nonprofit-that-worked-with-wuhan-institute/>
- <sup>1441</sup> “Wuhan Institute of Virology Holds 2019 Specialized Training on National Security”, *Wuhan Institute of Virology* (Online), 13 May 2019.
- <sup>1442</sup> For example, see “Party Branch of the Wuhan Institute of Virology Microbiological Resources and Bioinformatics Research Center Organizes Monthly Party Day Activities and Specialized Investigation and Study of ‘Staying True to our Original Aspiration, Keeping Firmly in Mind our Mission’” Wuhan Institute of Virology (Online), 22 July 2019. See also, “Wuhan Institute of Virology Organizes Centralized Study on the Educational Theme of ‘Staying True to our Original Aspiration, Keeping Firmly in Mind our Mission’,” Wuhan Institute of Virology (Online), 09 July 2019.
- <sup>1443</sup> Ai Hongxia, “Testing Begins for Special Passage through Airport for Military World Games”, Hebei Daily reprinted by Xinhua (Online), 26 September 2019.
- <sup>1444</sup> Cao C. (2021). China's evolving biosafety/biosecurity legislations. *J Law Biosci*. 8(1):lsab020. <https://doi.org/10.1093/jlb/lsab020> <https://academic.oup.com/jlb/article/8/1/lsab020/6311556>

- <sup>1445</sup> See “Keep Firmly in Mind Your Responsibilities, Hold Fast to the Mission, Be a Pioneer for our Nation in the Realm of High-Level Biosafety – The Achievements of the Zhengdian Lab Party Branch of the Chinese Academy of Sciences Wuhan Institute of Virology, Wuhan Institute of Virology (Online), 12 November 2019.
- <sup>1446</sup> See “Wuhan Institute of Virology Launches Training on Safety Work”, Wuhan Institute of Virology (Online), 21 November 2019.
- <sup>1447</sup> See “Wuhan Institute of Virology Launches Training on Safety Work”, Wuhan Institute of Virology (Online), 21 November 2019.
- <sup>1448</sup> See “Wuhan Institute of Virology Launches Training on Safety Work”, Wuhan Institute of Virology (Online), 21 November 2019.
- <sup>1449</sup> Li Hongliang’s resignation from the Dean of the Wuhan University for her daughters’ study of “drinking tea to fight cancer.” <https://www.bannedbook.org/en/bnews/baitai/20200917/1398148.html>
- <sup>1450</sup> Global Times. (September 16, 2020). Professor in Wuhan removed from posts after his children won a national-level science prize. <https://www.globaltimes.cn/page/202009/1201086.shtml>
- <sup>1451</sup> Pike RM (1976). Laboratory-acquired infections: summary and analysis of 3921 cases. *Health Lab Sci.* 13(2):105-114. <https://pubmed.ncbi.nlm.nih.gov/946794/>
- <sup>1452</sup> Shi, Z. (2020). Tracing the source of SARS for 13 years, how do wild animal viruses infect people? China Science Discovery Center. <https://docs.google.com/document/d/e/2PACX-1vQoYgoGPZfumLKc4CiaH42aNjnQqiOWHx5uY187mTZKG0411KckwLbIHUR95YslyROBG3OYUP64rRC9/pub>  
[https://mp.weixin.qq.com/s?src=11&timestamp=1680263778&ver=4440&signature=D9i25jQS\\*VD3ujHgA\\*sFxgvER5SfB2G2yqqaJxGJ4olpDtJ4Ddw2BBk-f6j-buZIIhuyEmn5aUfMD\\*A\\*byMWv9zI8Pck6dI0ErFPjtfjhR411TbosroOE1aArA\\*tBOzJ&new=1](https://mp.weixin.qq.com/s?src=11&timestamp=1680263778&ver=4440&signature=D9i25jQS*VD3ujHgA*sFxgvER5SfB2G2yqqaJxGJ4olpDtJ4Ddw2BBk-f6j-buZIIhuyEmn5aUfMD*A*byMWv9zI8Pck6dI0ErFPjtfjhR411TbosroOE1aArA*tBOzJ&new=1)
- <sup>1453</sup> Youth in the Wild. (2019). The Invisible Line of Defense (English subtitled version). [https://www.youtube.com/watch?feature=emb\\_logo&v=ovNuyTRMERI&app=desktop](https://www.youtube.com/watch?feature=emb_logo&v=ovNuyTRMERI&app=desktop)
- <sup>1454</sup> Aguilar-Setién, A., Aréchiga-Ceballos, N., Balsamo, G. A., Behrman, A. J., Frank, H. K., Fujimoto, G. R., Gilman Duane, E., Hudson, T. W., Jones, S. M., Ochoa Carrera, L. A., Powell, G. L., Smith, C. A., Triantis Van Sickle, J., & Vleck, S. E. (2022). Biosafety Practices When Working with Bats: A Guide to Field Research Considerations. *Applied biosafety : journal of the American Biological Safety Association*, 27(3), 169–190. <https://doi.org/10.1089/apb.2022.0019>
- <sup>1455</sup> Na, L., Hu, L., Jin, A., Li, J. (2019). Biosafety laboratory risk assessment. *Journal of Biosafety and Biosecurity*. 1; 90-92. <https://doi.org/10.1016/j.jobb.2019.01.011>
- <sup>1456</sup> Burrell CJ, Howard CR, Murphy FA. (2017). Laboratory Diagnosis of Virus Diseases. *Fenner and White's Medical Virology*. 135-154. <https://doi.org/10.1016/B978-0-12-375156-0.00010-2>
- <sup>1457</sup> Yu P. (2019). Dissertation: Geographic Evolution of Bat SARS-related Coronaviruses. Wuhan Institute of Virology. <https://docs.google.com/document/d/15U2uE7Eru0QxRbf8QVRPRMpssCoYhGvT/edit>, where a WIV graduate student describes efforts to isolate bat SARS-related coronaviruses from 9,261 samples.
- <sup>1458</sup> Li, N., Hu, L., Jin, A., Li, J. (2019). Biosafety laboratory risk assessment. *Journal of Biosafety and Biosecurity*. 2019;1(2):90-92. <https://doi.org/10.1016/j.jobb.2019.01.011>  
<https://www.sciencedirect.com/science/article/pii/S2588933818300165>; See <https://docs.google.com/document/d/15U2uE7Eru0QxRbf8QVRPRMpssCoYhGvT/edit>, where a WIV graduate student notes pipetting and high speed centrifugation of viral nucleic acids collected during a field expedition.
- <sup>1459</sup> *Id.*
- <sup>1460</sup> National Institutes of Health Monograph. (1979). Measures to decrease hazards from aerosol s from Laboratory Operations. [https://ovpr.uchc.edu/wp-content/uploads/sites/2568/2015/11/3.2.3.E\\_Aerosols.II\\_.pdf](https://ovpr.uchc.edu/wp-content/uploads/sites/2568/2015/11/3.2.3.E_Aerosols.II_.pdf) pg. 20
- <sup>1461</sup> See Li N, Hu L, Jin A, Li J.(2019). Biosafety laboratory risk assessment. *Journal of Biosafety and Biosecurity*. 1(2):90-92. <https://doi.org/10.1016/j.jobb.2019.01.011> , where the authors notes risk of infection from aerosols due to centrifugation as “high”.
- <sup>1462</sup> National Institutes of Health Monograph. (1979). Measures to decrease hazards from aerosol s from Laboratory Operations. [https://ovpr.uchc.edu/wp-content/uploads/sites/2568/2015/11/3.2.3.E\\_Aerosols.II\\_.pdf](https://ovpr.uchc.edu/wp-content/uploads/sites/2568/2015/11/3.2.3.E_Aerosols.II_.pdf) pg. 20
- <sup>1463</sup> Li N, Hu L, Jin A, Li J. Biosafety laboratory risk assessment. *Journal of Biosafety and Biosecurity*. 2019;1(2):90-92. <https://doi.org/10.1016/j.jobb.2019.01.011>
- <sup>1464</sup> *Id.*



- <sup>1465</sup> Zeng L-P. (2017) Dissertation: Reverse Genetic System of Bat SARS-like coronaviruses and function of ORFX. Wuhan Institute of Virology, Chinese Academy of Sciences.  
<https://twitter.com/TheSeeker268/status/1392575246843080704/photo/1>
- <sup>1466</sup> Zeng, L. P., Gao, Y. T., Ge, X. Y., Zhang, Q., Peng, C., Yang, X. L., Tan, B., Chen, J., Chmura, A. A., Daszak, P., & Shi, Z. L. (2016). Bat Severe Acute Respiratory Syndrome-Like Coronavirus WIV1 Encodes an Extra Accessory Protein, ORFX, Involved in Modulation of the Host Immune Response. *Journal of virology*, *90*(14), 6573–6582. <https://doi.org/10.1128/JVI.03079-15>
- <sup>1467</sup> See <https://docs.google.com/document/d/15U2uE7Eru0QxRbf8QVRPRMpsCoYhGvT/edit>, where a WIV graduate student describes the extraction of viral nucleic acids from 170 SARS-related viruses in BSL-2.
- <sup>1468</sup> Hu B, Zeng LP, Yang XL, et al. Discovery of a rich gene pool of bat SARS-related coronaviruses provides new insights into the origin of SARS coronavirus. Drosten C, ed. *PLOS Pathogens*. 2017;13(11):e1006698. doi:10.1371/journal.ppat.1006698 <https://pubmed.ncbi.nlm.nih.gov/29190287/>
- <sup>1469</sup> Sewell DL. Laboratory-acquired infections and biosafety. *Clin Microbiol Rev*. 1995;8(3):389-405. doi:10.1128/CMR.8.3.389 <https://www.ncbi.nlm.nih.gov/pmc/articles/PMC174631/pdf/080389.pdf>
- <sup>1470</sup> Reply to Science Magazine. <https://www.science.org/pb-assets/PDF/News%20PDFs/Shi%20Zhengli%20Q&A-1630433861.pdf>
- <sup>1471</sup> Guo M, Wang Y, Liu J, Huang Z, Li X. Biosafety and data quality considerations for animal experiments with highly infectious agents at ABSL-3 facilities. *J Biosaf Biosecur*. 2019;1(1):50-55. <https://doi.org/10.1016/j.jobb.2018.12.011>
- <sup>1472</sup> *Id.*
- <sup>1473</sup> *Id.*
- <sup>1474</sup> Qui J. Meet the scientist at the center of the covid lab leak controversy. MIT Technology Review 2022. <https://www.technologyreview.com/2022/02/09/1044985/shi-zhengli-covid-lab-leak-wuhan/>
- <sup>1475</sup> Xiao X, Newman C, Buesching CD, Macdonald DW, Zhou Z-M. Animal sales from Wuhan wet markets immediately prior to the COVID-19 pandemic. *Nature*. 2021. 11:111898. <https://doi.org/10.1038/s41598-021-2>
- <sup>1476</sup> Cohen J. Wuhan coronavirus hunter Shi Zhengli speaks out. *Sciences* 2020. <https://doi.org/10.1126/science.abd9835>
- <sup>1477</sup> The sales of the experimental pigs, cattle, and milk totaled 10,179,201.86 yuan (US \$ 1.46 million). (文书全文. Court.gov.cn. Published 2022. Accessed October 5, 2022. <http://wenshu.court.gov.cn/website/wenshu/181107ANFZ0BXSK4/index.html?docId=8d2ef016c4824e818e90ab370113a270>)
- <sup>1478</sup> Article 47 Biosecurity Law of the P.R.C. Available at <https://www.chinalawtranslate.com/en/biosecurity-law/>
- <sup>1479</sup> Guo M, Wang Y, Liu J, Huang Z, Li X. Biosafety and data quality considerations for animal experiments with highly infectious agents at ABSL-3 facilities. *J Biosaf Biosecur*. 2019;1(1):50-55. doi:10.1016/j.jobb.2018.12.011
- <sup>1480</sup> Singh VK, Newman VL, Berg AN, et al. Animal models for acute radiation syndrome drug discovery. *Expert Opin Drug Discov*. 2015;10(5): 497–517.
- <sup>1481</sup> Reply to Science Magazine. <https://www.science.org/pb-assets/PDF/News%20PDFs/Shi%20Zhengli%20Q&A-1630433861.pdf>
- <sup>1482</sup> This is in spite of Shi Zhengli stating the data would be “published soon.” See Reply to Science Magazine. <https://www.science.org/pb-assets/PDF/News%20PDFs/Shi%20Zhengli%20Q&A-1630433861.pdf>
- <sup>1483</sup> Luo, F., Liao, F. L., Wang, H., Tang, H. B., Yang, Z. Q., & Hou, W. (2018). Evaluation of Antibody-Dependent Enhancement of SARS-CoV Infection in Rhesus Macaques Immunized with an Inactivated SARS-CoV Vaccine. *Virologica Sinica*, *33*(2), 201–204. <https://doi.org/10.1007/s12250-018-0009-2>
- <sup>1484</sup> Guo M, Yong M, Liu J, Huang X, Li X. Biosafety and data quality considerations for animal experiments with highly infectious agents at ABSL-3 facilities. *Journal of Biosafety and Biosecurity*. 2019. 1; 50-55. <http://creativecommons.org/licenses/by-nc-nd/4.0/>
- <sup>1485</sup> *Id.*
- <sup>1486</sup> *Id.*
- <sup>1487</sup> Powell DS, Walker RC, Heflin DT, et al. Development of novel mechanisms for housing, handling, and remote monitoring of common marmosets at animal biosafety level 3. *Pathog Dis*. 2014;71(2):219-226. <https://doi.org/10.1011/2049-632X.12140>
- <sup>1488</sup> Luo, F., Liao, F. L., Wang, H., Tang, H. B., Yang, Z. Q., & Hou, W. (2018). Evaluation of Antibody-Dependent Enhancement of SARS-CoV Infection in Rhesus Macaques Immunized with an Inactivated SARS-CoV Vaccine. *Virologica Sinica*, *33*(2), 201–204. <https://doi.org/10.1007/s12250-018-0009-2>

- <sup>1489</sup> Li N, Hu L, Jin A, Li J. Biosafety laboratory risk assessment. *Journal of Biosafety and Biosecurity*. 2019;1(2):90-92. <https://doi.org/10.1016/j.jobb.2019.01.011>
- <sup>1490</sup> Guo M, Wang Y, Liu J, Huang Z, Li X. Biosafety and data quality considerations for animal experiments with highly infectious agents at ABSL-3 facilities. *J Biosaf Biosecur*. 2019;1(1):50-55. <https://doi.org/10.1016/j.jobb.2018.12.011> 1
- <sup>1491</sup> *Id.*
- <sup>1492</sup> Powell DS, Walker RC, Heflin DT, et al. Development of novel mechanisms for housing, handling, and remote monitoring of common marmosets at animal biosafety level 3. *Pathog Dis*. 2014;71(2):219-226. <https://doi.org/10.1011/2049-632X.12140>
- <sup>1493</sup> Ming G, Yong, W, Jinbiao L, Zhixiang H, Xiandong L. Biosafety and data quality considerations for animal experiments with highly infectious agents at ABSL-3 facilities. *Journal of Biosafety and Biosecurity*. 2019. 1:50-55. <https://doi.org/10.1016/j.obb.2018.12.011>
- <sup>1494</sup> Guo M, Yong M, Liu J, Huang X, Li X. Biosafety and data quality considerations for animal experiments with highly infectious agents at ABSL-3 facilities. *Journal of Biosafety and Biosecurity*. 2019. 1; 50-55. <http://creativecommons.org/licenses/by-nc-nd/4.0/>
- <sup>1495</sup> *Id.* “Infectious aerosols In (*sic*) the handling of animals, changing cages, dumping bedding, etc., it is easy to produce infectious aerosols from infected animal skins, furs, and bedding. These infectious aerosols are a potential hazard to workers and the environment.”
- <sup>1496</sup> Ming G, Yong, W, Jinbiao L, Zhixiang H, Xiandong L. Biosafety and data quality considerations for animal experiments with highly infectious agents at ABSL-3 facilities. *Journal of Biosafety and Biosecurity*. 2019. 1:50-55. <https://doi.org/10.1016/j.obb.2018.12.011>
- <sup>1497</sup> Powell DS, Walker RC, Heflin DT, et al. Development of novel mechanisms for housing, handling, and remote monitoring of common marmosets at animal biosafety level 3. *Pathog Dis*. 2014;71(2):219-226. <https://doi.org/10.1011/2049-632X.12140>
- <sup>1498</sup> Guo M, Yong M, Liu J, Huang X, Li X. Biosafety and data quality considerations for animal experiments with highly infectious agents at ABSL-3 facilities. *Journal of Biosafety and Biosecurity*. 2019. 1; 50-55. <http://creativecommons.org/licenses/by-nc-nd/4.0/>
- <sup>1499</sup> Guo M, Yong M, Liu J, Huang X, Li X. Biosafety and data quality considerations for animal experiments with highly infectious agents at ABSL-3 facilities. *Journal of Biosafety and Biosecurity*. 2019. 1; 50-55. <http://creativecommons.org/licenses/by-nc-nd/4.0/>
- <sup>1500</sup> Li N, Hu L, Jin A, Li J. Biosafety laboratory risk assessment. *Journal of Biosafety and Biosecurity*. 2019;1(2):90-92. <https://doi.org/10.1016/j.jobb.2019.01.011>
- <sup>1501</sup> Temmam, S., Montagutelli, X. Hérate, C. et al. SARS-CoV-2-Related Bat Virus in Human Relevant Models Sheds Light on the Proximal Origin of COVID-19, 30 June 2022, PREPRINT (Version 1) available at Research Square <https://doi.org/10.21203/rs.3.rs-1803095/v1>
- <sup>1502</sup> Li, W., Wicht, O., van Kuppeveld, F. J., He, Q., Rottier, P. J., & Bosch, B. J. (2015). A Single Point Mutation Creating a Furin Cleavage Site in the Spike Protein Renders Porcine Epidemic Diarrhea Coronavirus Trypsin Independent for Cell Entry and Fusion. *Journal of virology*, 89(15), 8077–8081. <https://doi.org/10.1128/JVI.00356-15>
- <sup>1503</sup> Yamada, Y., & Liu, D. X. (2009). Proteolytic activation of the spike protein at a novel RRRR/S motif is implicated in furin-dependent entry, syncytium formation, and infectivity of coronavirus infectious bronchitis virus in cultured cells. *Journal of virology*, 83(17), 8744–8758. <https://doi.org/10.1128/JVI.00613-09>
- <sup>1504</sup> Follis, K. E., York, J., & Nunberg, J. H. (2006). Furin cleavage of the SARS coronavirus spike glycoprotein enhances cell-cell fusion but does not affect virion entry. *Virology*, 350(2), 358–369. <https://doi.org/10.1016/j.virol.2006.02.003>
- <sup>1505</sup> EcoHealth Alliance. Draft Defense Advanced Research Projects Agency proposal. Project DEFUSE: Defusing the threat of bat-borne coronaviruses. March 2018. HR001118S0017-PREEMPT-PA 001
- <sup>1506</sup> Pohl, M. O., Busnadiego, I., Kufner, V., Glas, I., Karakus, U., Schmutz, S., Zaheri, M., Abela, I., Trkola, A., Huber, M., Stertz, S., & Hale, B. G. (2021). SARS-CoV-2 variants reveal features critical for replication in primary human cells. *PLoS biology*, 19(3), e3001006. <https://doi.org/10.1371/journal.pbio.3001006>
- <sup>1507</sup> Johnson, B. A., Xie, X., Kalveram, B., Lokugamage, K. G., Muruato, A., Zou, J., Zhang, X., Juelich, T., Smith, J. K., Zhang, L., Bopp, N., Schindewolf, C., Vu, M., Vanderheiden, A., Swetnam, D., Plante, J. A., Aguilar, P., Plante, K. S., Lee, B., Weaver, S. C., ... Menachery, V. D. (2020). Furin Cleavage Site Is Key to SARS-CoV-2 Pathogenesis. *bioRxiv : the preprint server for biology*, 2020.08.26.268854. <https://doi.org/10.1101/2020.08.26.268854>

- <sup>1508</sup>The Epidemiological Characteristics of an Outbreak of 2019 Novel Coronavirus Diseases (COVID-19) — China, 2020. *China CDC Weekly*. 2020;2(8):113-122. Source: <https://doi.org/10.46234/ccdcw2020.032>
- <sup>1509</sup> See, Do three new studies add up to proof of COVID-19's origin in a Wuhan animal market? [www.science.org](http://www.science.org). <https://www.science.org/content/article/do-three-new-studies-add-proof-covid-19-s-origin-wuhan-animal-market>, discussing researchers “modeled what would have happened if there was an introduction of a single lineage and compared that with the viruses sequenced from Wuhan cases through 23 January 2020. By matching the sequence data from the actual epidemic, they found there was only a 3.6% chance that a single lineage mutated into a second one.”
- <sup>1510</sup> Lau, S., Luk, H., Wong, A., Li, K., Li, S.M., Zhu, L., He, Z., Fung, J., Chan, T., Fung, K., Woo, P. (2020) "Possible bat origin of severe acute respiratory syndrome coronavirus 2." *Emerging infectious diseases* 26, no. 7: 1542. <https://doi.org/10.3201/eid2607.200092>
- <sup>1511</sup> U.S. Centers for Disease Control and Prevention. (2012) Introduction to Epidemiology: Epidemic Patterns: Common Source <https://www.cdc.gov/csels/dsepd/ss1978/Lesson1/Section11.html#ALT121>
- <sup>1512</sup> Worobey, M., Levy, J. I., Malpica Serrano, L., Crits-Christoph, A., Pekar, J. E., Goldstein, S. A., Rasmussen, A. L., Kraemer, M. U. G., Newman, C., Koopmans, M. P. G., Suchard, M. A., Wertheim, J. O., Lemey, P., Robertson, D. L., Garry, R. F., Holmes, E. C., Rambaut, A., & Andersen, K. G. (2022). The Huanan Seafood Wholesale Market in Wuhan was the early epicenter of the COVID-19 pandemic. *Science (New York, N.Y.)*, 377(6609), 951–959. <https://doi.org/10.1126/science.abp8715>
- <sup>1513</sup> Pekar, J. E., Magee, A., Parker, E., Moshiri, N., Izhikevich, K., Havens, J. L., Gangavarapu, K., Malpica Serrano, L. M., Crits-Christoph, A., Matteson, N. L., Zeller, M., Levy, J. I., Wang, J. C., Hughes, S., Lee, J., Park, H., Park, M. S., Ching Zi Yan, K., Lin, R. T. P., Mat Isa, M. N., ... Wertheim, J. O. (2022). The molecular epidemiology of multiple zoonotic origins of SARS-CoV-2. *Science (New York, N.Y.)*, 377(6609), 960–966. <https://doi.org/10.1126/science.abp8337> ; Du Z, Javan E, Nugent C, Cowling BJ, Meyers LA. Using the COVID-19 to influenza ratio to estimate early pandemic spread in Wuhan, China and Seattle, US. *EclinicalMedicine*. 2020;26:100479. doi:10.1016/j.eclinm.2020.100479 <https://pubmed.ncbi.nlm.nih.gov/32838239/>
- <sup>1514</sup> Worobey, M., Levy, J.I., Serrano, L.M., et al. The Huanan Seafood Wholesale Market in Wuhan was the early epicenter of the COVID-19 pandemic. *Science*. Published online July 26, 2022. doi:10.1126/science.abp8715 <https://www.science.org/doi/10.1126/science.abp8715>
- <sup>1515</sup> Rambaut, A., Holmes, E.C., O’Toole, Á., et al. (2020). A dynamic nomenclature proposal for SARS-CoV-2 lineages to assist genomic epidemiology. *Nature Microbiology*. Published online July 15, 2020. <https://doi.org/10.1038/s41564-020-0770-5> <https://www.ncbi.nlm.nih.gov/pmc/articles/PMC7610519/>; Bedford Cohen Interview Science
- <sup>1516</sup> World Health Organization (2020). Origin of SARS-CoV-2. [https://apps.who.int/iris/bitstream/handle/10665/332197/WHO-2019-nCoV-FAQ-Virus\\_origin-2020.1-eng.pdf](https://apps.who.int/iris/bitstream/handle/10665/332197/WHO-2019-nCoV-FAQ-Virus_origin-2020.1-eng.pdf);
- <sup>1517</sup> Pekar, J. E., Magee, A., Parker, E., Moshiri, N., Izhikevich, K., Havens, J. L., Gangavarapu, K., Malpica Serrano, L. M., Crits-Christoph, A., Matteson, N. L., Zeller, M., Levy, J. I., Wang, J. C., Hughes, S., Lee, J., Park, H., Park, M. S., Ching Zi Yan, K., Lin, R. T. P., Mat Isa, M. N., ... Wertheim, J. O. (2022). The molecular epidemiology of multiple zoonotic origins of SARS-CoV-2. *Science (New York, N.Y.)*, 377(6609), 960–966. <https://doi.org/10.1126/science.abp8337>
- <sup>1518</sup> Cobb, N.L., Collier S, Attia EF, Augusto O, West TE, Wagenaar BH (2022) Global influenza surveillance systems to detect the spread of influenza-negative influenza-like illness during the COVID-19 pandemic: Time series outlier analyses from 2015–2020. *PLoS Med* 19(7): e1004035. <https://doi.org/10.1371/journal.pmed.1004035>
- <sup>1519</sup> Lee, E. Chasing the virus origin to prepare for the future: a systems approach in analyzing the origin of SARS-CoV-2. 2022 (pre-print)
- <sup>1520</sup> Jarvis, M.C. Aerosol Transmission of SARS-CoV-2: Physical Principles and Implications. *Front Public Health*. 2020;8:590041. Published 2020 Nov 23. <https://doi.org/10.3389/fpubh.2020.590041> Wang Z, Fu Y, Guo Z, et al. Transmission and prevention of SARS-CoV-2. *Biochem Soc Trans*. 2020;48(5):2307-2316. <https://doi.org/10.1042/BST20200693>
- <sup>1521</sup> “Keep Firmly in Mind Your Responsibilities, Hold Fast to the Mission, Be a Pioneer for our Nation in the Realm of High-Level Biosafety – The Achievements of the Zhengdian Lab Party Branch of the Chinese Academy of Sciences Wuhan Institute of Virology, Wuhan Institute of Virology (Online), 12 November 2019.
- <sup>1522</sup> Infographic: Biosafety Lab Levels. Published 2020. <https://www.cdc.gov/cpr/infographics/biosafety.htm>
- <sup>1523</sup> Wedum, A.G. Laboratory Safety in Research with Infectious Aerosols. *Public Health Reports (1896-1970)*. 1964;79(7):619-633. doi:10.2307/4592205; Sewell DL. Laboratory-acquired infections: Are microbiologists at risk?. *Clin Microbiol Newsl*. 2006;28(1):1-6. doi:10.1016/j.clinmicnews.2005.12.004

- <sup>1524</sup> Wu, G. Laboratory biosafety in China: past, present and future. *Journal of Biosafety and Health*. 2019: 56-58. <http://dx.doi.org/10.1016/j.bsheal.2019.10.003>
- <sup>1525</sup> Eban, K. *The Lab-Leak Theory: Inside the Fight to Uncover COVID-19's Origins*. Vanity Fair. Published June 3, 2021. <https://www.vanityfair.com/news/2021/06/the-lab-leak-theory-inside-the-fight-to-uncover-covid-19s-origins>.
- <sup>1526</sup> “Wuhan Municipal People’s Government General Office Notice Regarding the Issuance of the Implementation Plan for Reforming and Improving the Comprehensive Supervision System of the Medical and Health Industries in Wuhan”, Wuhan Municipal People’s Government (Online), 21 April 2020.
- <sup>1527</sup> Ai Hongxia (艾红霞), “Testing Begins for Special Passage through Airport for Military World Games” Hebei Daily reprinted by Xinhua (Online), 26 September 2019.
- <sup>1528</sup> “PCR Purchasing Report Wuhan China,” *Internet 2.0 Relentless Security*, October 2021, p. 9. Jamie Tarabay, “Bloomberg Government: China PCR Purchases Increased Before First Known Covid Cases,” Bloomberg Government (Online), 04 October 2021. <https://internet2-0.com/PCR%20Purchasing%20Report%20Wuhan%20China.pdf>
- <sup>1529</sup> Rindsberg, A. China “began stockpiling PPE months before Covid outbreak.” *The Telegraph*. <https://www.telegraph.co.uk/news/2022/10/08/china-began-stockpiling-ppe-months-covid-outbreak> Published October 8, 2022. Accessed October 10, 2022.; “Central Committee No. 15 Patrol Inspection Group Opens Meeting on the Inspection of the Party Organization of the Chinese Academy of Sciences and its Mobilization Work” *China Science Daily* as reprinted on the Chinese Academy of Sciences (Online), 16 September 2019.
- <sup>1530</sup> Jiali, W. Competitive consultation on central-air-conditioning renovation project of Wuhan Institute of Virology, Chinese Academy Sciences China Government Procurement Network, September 16, 2019; “The Wuhan Institute of Virology of the Chinese Academy of Sciences plans to use a single-source procurement method to publicize the procurement of air incineration devices and test service projects.” China Government Procurement Network, 3 Dec. 2019, <https://archive.is/bfoTD#selection-229.0-229.131>
- <sup>1531</sup> Cohen, J. (2020). Wuhan coronavirus hunter Shi Zhengli speaks out. *Science*. 369(6503):487-488. <https://doi.org/10.1126/science.369.6503.487> (written responses).
- <sup>1532</sup> Wu, G. (2019). Laboratory biosafety in China: past, present and future. *Journal of Biosafety and Health*. 2019. 1: 56-58. <http://dx.doi.org/10.1016/j.bsheal.2019.10.003>
- <sup>1533</sup> Feng, L., Wang, Q., Shan, C. *et al.* (2020). An adenovirus-vectored COVID-19 vaccine confers protection from SARS-COV-2 challenge in rhesus macaques. *Nat Commun* **11**, 4207 (2020). <https://doi.org/10.1038/s41467-020-18077-5>
- <sup>1534</sup> Yao, Y.F., Wang, Z.J., Jiang, R.D., *et al.* (2021). Protective Efficacy of Inactivated Vaccine against SARS-CoV-2 Infection in Mice and Non-Human Primates. *Viol. Sin.* **36**, 879–889. <https://doi.org/10.1007/s12250-021-00376-w>
- <sup>1535</sup> Na, L., Hu, L., Jin, A., Li, J. (2019). Biosafety laboratory risk assessment. *Journal of Biosafety and Biosecurity*. 1; 90-92. <https://doi.org/10.1016/j.jobb.2019.01.011>
- <sup>1536</sup> Guo, M., Wang, Y., Liu, J., Huang, Z., Li, X. (2019). Biosafety and data quality considerations for animal experiments with highly infectious agents at ABSL-3 facilities. *J Biosaf Biosecur.* 1(1):50-55. <https://doi.org/10.1016/j.jobb.2018.12.011>
- <sup>1537</sup> Wuhan Institute of Virology CAS. (2018). A kind of air heave type hermatic door for high-level biosafety laboratory. CN Patent No.108915501 A. 2018.11.30 <https://patents.google.com/patent/CN108915501A/en>
- <sup>1538</sup> Wuhan Institute of Virology CAS.(2019). A kind of continous way high-level biosafety laboratory wastewater inactivating device and method. CN Patent No.110040799 A.2019.07.23. <https://patentimages.storage.googleapis.com/ad/c5/33/24d02f74968a75/CN110040799A.pdf> <https://patents.google.com/patent/CN110040799A/en>;
- <sup>1539</sup> Wuhan Institute of Virology CAS.(2018). A kind of air heavy type hermatic door for high-level biosafety laboratory. CN Patent No.108915501 A. 2018.11.30. <https://patentimages.storage.googleapis.com/12/25/71/4cdcb205274e4b/CN108915501A.pdf> <https://patents.google.com/patent/CN108915501A/en>
- <sup>1540</sup> Wuhan Institute of Virology CAS. (2019). A kind of continous way high-level biosafety laboratory wastewater inactivating device and method. CN Patent No.110040799 A.2019.07.23. <https://patentimages.storage.googleapis.com/ad/c5/33/24d02f74968a75/CN110040799A.pdf> <https://patents.google.com/patent/CN110040799A/en>
- <sup>1541</sup> Gao, D., Zhang, Q., Han, K., Qian, Q., Wenbo, A. (2019). Google Patent: Integrated Biological Sensor CN 201922213832.2. December 11, 2019. <https://patents.google.com/patent/CN211375358U/en?assignee=Wuhan+Institute+of+Virology+of+CAS&sort=new&page=8>

- <sup>1542</sup> Wuhan Institute of Virology. (2019). Patent:No. 201910325059.0 Biosafety autoclave and sterilization method. <https://patents.google.com/patent/CN210078382U/en?assignee=Wuhan+Institute+of+Virology+of+CAS&sort=new&page=12>
- <sup>1543</sup> Jia, W., Zhiming, Y., Hao, T., Jun, L., Hao, Q., Yi, L., Lin, W. (2020). Google Patents. Object surface disinfectant for high-grade biosafety laboratory and preparation method thereof. <https://patents.google.com/patent/CN112262846B/en?assignee=Wuhan+Institute+of+Virology+of+CAS&sort=new&page=5>
- <sup>1544</sup> Jiali, W. Competitive consultation on central-air-conditioning renovation project of Wuhan Institute of Virology, Chinese Academy Sciences China Government Procurement Network, September 16, 2019; “The Wuhan Institute of Virology of the Chinese Academy of Sciences plans to use a single-source procurement method to publicize the procurement of air incineration devices and test service projects.” China Government Procurement Network, 3 Dec. 2019, <https://archive.is/Jifqr#selection-229.0-229.197>
- <sup>1545</sup> “Keep Firmly in Mind Your Responsibilities, Hold Fast to the Mission, Be a Pioneer for our Nation in the Realm of High-Level Biosafety – The Achievements of the Zhengdian Lab Party Branch of the Chinese Academy of Sciences Wuhan Institute of Virology, Wuhan Institute of Virology (Online), 12 November 2019.
- <sup>1546</sup> Wan, Y., Shang, J., Sun, S., et al. (2020). Molecular Mechanism for Antibody-Dependent Enhancement of Coronavirus Entry. *J Virol.* 94(5):e02015-19. Published 2020 Feb 14. doi:10.1128/JVI.02015-19 <https://doi.org/10.1128/JVI.02015-19>
- <sup>1547</sup> Zhou Y, Zhao G, Gu H; Sun S, He L, Li Y, Han G, Lang X, Liu J, Geng S, Sheng X.(2020). Novel coronavirus COVID-19 vaccine, preparation method and application thereof. Beijing Preliminary Intellectual Property Agency Co., Ltd. 11736. February 24, 2020. CN111333704A, available at <https://patentscope.wipo.int/search/en/detail.jsf?docId=CN298978866>
- <sup>1548</sup> Sun, S-H., He, L., Zhao, Z., Gu, H., Wang, T., Yang, T., et al. (2021). Recombinant vaccine containing an RBD-Fc fusion induced protection against SARS-CoV-2 in nonhuman primates and mice. *Nature Cellular & Molecular Immunology.* 18: 1070-1073. <https://doi.org/10.1038/s41423-021-00658-z>
- <sup>1549</sup> Yan J, Wang W, Chen Z, Lu S, Yang F, Bi Z, Bao L, Mo F, Huang Y, Hong W...Wei X. (2020). A vaccine targeting the RBD of the S protein of SARS-CoV-2 induces protective immunity. *Nature.* 586, 572-577. <https://doi.org/10.1038/s41586-020-2599-8>
- <sup>1550</sup> Pan, X., Zhou, P., Fan, T., Wu, Y., Zhang, J., Shi, X., Shang, W.,...Chen, Z., Xiao, G. (2020). Immunoglobulin fragment F(ab')<sub>2</sub> against RBD potentially neutralizes SARS-CoV-2 in vitro. bioRxiv preprint. <https://doi.org/10.1101/2020.04.07029884>;
- <sup>1551</sup> Dai, L., Gao, L., Tao, S.R., Hadiinegoro, M., Erkin, Z., Ying, P., He, R.T., Girsang, H.Yan, J., Hu, Z., Li, C., Abdkurakmonov, I.Y., Gao, G.F. (2022). Efficacy and Safety of the RBD-Dimer-based COVID-19 vaccine zf2001 in adults. *NEJM.* <https://doi.org/NEJMoa2202261>
- <sup>1552</sup> Gong, R., Xiao, G., Zhang, H., Zhang, Z., et al. (2020). Subunit vaccine against novel coronavirus and its application. Patent agency Wuhan Dachu Intellectual Property Agency. April 24, 2020. <https://patentimages.storage.googleapis.com/70/ae/29/c7b38ddee5921a/CN111533809A.pdf>
- <sup>1553</sup> Gu, H., Chen, Q., Yang, G., He, L., Fan, H., Deng, Y. Q., Wang, Y., Teng, Y., Zhao, Z., Cui, Y., Li, Y., Li, X. F., Li, J., Zhang, N. N., Yang, X., Chen, S., Guo, Y., Zhao, G., Wang, X., Luo, D. Y., ... Zhou, Y. (2020). Adaptation of SARS-CoV-2 in BALB/c mice for testing vaccine efficacy. *Science (New York, N.Y.)*, 369(6511), 1603–1607. <https://doi.org/10.1126/science.abc4730>
- <sup>1554</sup> Sun, S., He, L., Zhao, Z. *et al.* (2021). Recombinant vaccine containing an RBD-Fc fusion induced protection against SARS-CoV-2 in nonhuman primates and mice. *Cell Mol Immunol* 18, 1070–1073. <https://doi.org/10.1038/s41423-021-00658-z>
- <sup>1555</sup> Gu, H., Chen, Q., Yang, G., He, L., Deng, Y-Q., et al. (2020). Adaptation of SARS-CoV-2 in BALB/c mice for testing vaccine efficacy. *Science.* 369; 1607-1607. <https://doi.org/10.1126/science.abc4730>
- <sup>1556</sup> Guo, M., Wang, Y., Liu, J., Huang, Z., Li, X. (2019). Biosafety and data quality considerations for animal experiments with highly infectious agents at ABSL-3 facilities. *J Biosaf Biosecur.* 1(1):50-55. <https://doi.org/10.1016/j.jobbb.2018.12.011>
- <sup>1557</sup> Luo, F., Liao, F. L., Wang, H., Tang, H. B., Yang, Z. Q., & Hou, W. (2018). Evaluation of Antibody-Dependent Enhancement of SARS-CoV Infection in Rhesus Macaques Immunized with an Inactivated SARS-CoV Vaccine. *Virologica Sinica*, 33(2), 201–204. <https://doi.org/10.1007/s12250-018-0009-2>
- <sup>1558</sup> Zhou, J., Wang, W., Zhong, Q., Hou, W., Yang, Z., Xiao, S. Y., Zhu, R., Tang, Z., Wang, Y., Xian, Q., Tang, H., & Wen, L. (2005). Immunogenicity, safety, and protective efficacy of an inactivated SARS-associated coronavirus vaccine in rhesus monkeys. *Vaccine*, 23(24), 3202–3209. <https://doi.org/10.1016/j.vaccine.2004.11.075>

- <sup>1559</sup> The Institute of Model Animals of Wuhan University, China. (2016). *European Heart Journal*, Volume 37, Issue 43. Pages 3257–3259. <https://doi.org/10.1093/eurheartj/ehw445>
- <sup>1560</sup> An Y., Li, S., Jin, X., Han, J-B., Xu, K., Xu, S., Han, Y., Liu, C., Zheng, T., Liu, M., Yangm M., ... Yan, J., Zheng Y-T., Dai, L., Gao, G.F.(2022). A tandem-repeat dimeric RBD protein-based covid-19 vaccine zf2001 protects mice and nonhuman primates. *Emerging Microbes and Infection*. 11, 1058-1070. <https://doi.org/10.1080/22221751.2022>
- <sup>1561</sup> Feng, L., Wang, Q., Shan, C., Yang, C., Feng, Y., Wu, J., Liu, X., Zhou, Y., Jiang, R., Hu, P., Liu, X., Zhang, F., Li, P., Niu, X., Liu, Y., Zheng, X., Luo, J., Sun, J., Gu, Y., Liu, B., ... Chen, L. (2020). An adenovirus-vectored COVID-19 vaccine confers protection from SARS-CoV-2 challenge in rhesus macaques. *Nature communications*, 11(1), 4207. <https://doi.org/10.1038/s41467-020-18077-5>
- <sup>1562</sup> Luo, F., Liao, F. L., Wang, H., Tang, H. B., Yang, Z. Q., & Hou, W. (2018). Evaluation of Antibody-Dependent Enhancement of SARS-CoV Infection in Rhesus Macaques Immunized with an Inactivated SARS-CoV Vaccine. *Virologica Sinica*, 33(2), 201–204. <https://doi.org/10.1007/s12250-018-0009-2>
- <sup>1563</sup> Gu, H., Chen, Q., Yang, G., He, L., Fan, H., Deng, Y. Q., Wang, Y., Teng, Y., Zhao, Z., Cui, Y., Li, Y., Li, X. F., Li, J., Zhang, N. N., Yang, X., Chen, S., Guo, Y., Zhao, G., Wang, X., Luo, D. Y., ... Zhou, Y. (2020). Adaptation of SARS-CoV-2 in BALB/c mice for testing vaccine efficacy. Preprint [Rapid adaptation of SARS-CoV-2 in BALB/c mice: Novel mouse model for vaccine efficacy | bioRxiv](https://doi.org/10.1101/2020.08.11.201607)
- <sup>1564</sup> Gu, H., Chen, Q., Yang, G., He, L., Fan, H., Deng, Y. Q., Wang, Y., Teng, Y., Zhao, Z., Cui, Y., Li, Y., Li, X. F., Li, J., Zhang, N. N., Yang, X., Chen, S., Guo, Y., Zhao, G., Wang, X., Luo, D. Y., ... Zhou, Y. (2020). Adaptation of SARS-CoV-2 in BALB/c mice for testing vaccine efficacy. *Science (New York, N.Y.)*, 369(6511), 1603–1607. <https://doi.org/10.1126/science.abc4730>
- <sup>1565</sup> Dong, Y., Dai, T., Wei, Y., Zhang, L., Zheng, M., & Zhou, F. (2020). A systematic review of SARS-CoV-2 vaccine candidates. *Signal transduction and targeted therapy*, 5(1), 237. <https://doi.org/10.1038/s41392-020-00352-y>
- <sup>1566</sup> Zhao, J., Zhao, S., Ou, J., Zhang, J., Lan, W., Guan, W., Wu, X., Yan, Y., Zhao, W., Wu, J., Chodosh, J., & Zhang, Q. (2020). COVID-19: Coronavirus Vaccine Development Updates. *Frontiers in immunology*, 11, 602256. <https://doi.org/10.3389/fimmu.2020.602256>
- <sup>1567</sup> Li, Y. D., Chi, W. Y., Su, J. H., Ferrall, L., Hung, C. F., & Wu, T. C. (2020). Coronavirus vaccine development: from SARS and MERS to COVID-19. *Journal of biomedical science*, 27(1), 104. <https://doi.org/10.1186/s12929-020-00695-2>
- <sup>1568</sup> Yan, Z. P., Yang, M., & Lai, C. L. (2021). COVID-19 Vaccines: A Review of the Safety and Efficacy of Current Clinical Trials. *Pharmaceuticals (Basel, Switzerland)*, 14(5), 406. <https://doi.org/10.3390/ph14050406>
- <sup>1569</sup> Li, D. D., & Li, Q. H. (2021). SARS-CoV-2: vaccines in the pandemic era. *Military Medical Research*, 8(1), 1. <https://doi.org/10.1186/s40779-020-00296-y>
- <sup>1570</sup> Li, L., Guo, P., Zhang, X., Yu, Z., Zhang, W., & Sun, H. (2021). SARS-CoV-2 vaccine candidates in rapid development. *Human vaccines & immunotherapeutics*, 17(3), 644–653. <https://doi.org/10.1080/21645515.2020.1804777>